

FURUNO

MARINE VHF RADIOTELEPHONE

With Class D DSC Modem and CH70 with receiver

FM-4000

Owner's Manual

- Commercial grade ITU class D DSC transceiver
- Superior receiver performance (80 dB rejection)
- 30W LoudHailer complete with listen-back and four fog horns, bells, and whistle
- 2.2-inch internal speaker produces clear, loud audio
- 2.58" x 1.28" dot matrix display
- Alphanumeric keypad allows direct entry of channel numbers or selection of most used functions
- NAV mode displays latitude/longitude, position, time, SOG, COG*
- Oversized rotary selector, volume and squelch knobs
- Programmable scan, selectable priority scan, and dual watch
- One-button access to CH16 and CH9
- Treble and bass audio tone control
- Two inputs for optional Remote MIC
- Optional voice scrambler
- Multi-station intercom
- High and low voltage warnings

* When attached to GPS Receiver



TABLE OF CONTENTS

1	GENERAL INFORMATION	4
1.1	INTRODUCTION	4
2	PACKING LIST	5
3	OPTIONS	5
4.	SAFETY/WARNING INFORMATION	5
5	FCC RADIO LICENSE INFORMATION	6
5.1	STATION LICENSE	6
5.2	RADIO CALL SIGN	6
5.3	CANADIAN SHIP STATION LICENSING	6
5.4	FCC / INDUSTRY CANADA INFORMATION	6
6	FCC NOTICE	7
7	GETTING STARTED	8
7.1	ABOUT VHF RADIO	8
7.2	SELECTING AN ANTENNA	8
7.3	COAXIAL CABLE	8
8	INSTALLATION	9
8.1	LOCATION	9
8.2	OPTIONAL MMB-84 FLUSH MOUNT INSTALLATION	9
8.3	OPTIONAL CMP30 REMOTE MIC	10
8.4	ELECTRICAL CONNECTIONS	12
8.5	ACCESSORY CABLE	13
8.6	CHANGING THE TIME INDICATION	14
8.7	CHANGING THE COG INDICATION	14
9	CONTROLS AND INDICATORS	16
9.1	CONTROLS AND CONNECTIONS	16
10	BASIC OPERATION	22
10.1	PROHIBITED COMMUNICATIONS	22
10.2	RECEPTION	22
10.3	TRANSMISSION	23
10.4	TRANSMIT TIME-OUT TIMER (TOT)	23
10.5	SIMPLEX/DUPLEX CHANNEL USE	23
10.6	USA, CANADA, AND INTERNATIONAL MODE	23
10.7	NOAA WEATHER CHANNELS	24
10.7.1	NOAA Weather Alert	24
10.7.2	NOAA Weather Alert Testing	24
10.8	EMERGENCY (CH16 USE)	25
10.9	CALLING ANOTHER VESSEL (CH 16 OR CH9)	25
10.10	MAKING TELEPHONE CALLS	26
10.11	OPERATING ON CHANNELS 13 AND 67	26
10.12	DUAL WATCH (TO CH16)	27
10.13	SCANNING	27
10.13.1	Selecting the Scan Type	27
10.13.2	Memory Scanning (M-SCAN)	27
10.13.3	Priority Scanning (P-SCAN)	28
10.14	PA/FOG OPERATION	29
10.14.1	Operating the PA HAIL mode	29
10.14.2	Operating the FOG HORN mode	30
10.15	DISPLAY SOG AND COG INFORMATION	30
10.16	LCD DIMMER	30
10.17	INTERCOM OPERATION	32
10.17.1	Communication	32
10.17.2	Calling	33
10.18	VOICE SCRAMBLER	33

TABLE OF CONTENTS

11	DIGITAL SELECTIVE CALLING	34
11.1	GENERAL	34
11.2	MARITIME MOBILE SERVICE IDENTITY (MMSI)	34
11.2.1	What is an MMSI?	34
11.2.2	Programming the MMSI	35
11.3	DSC DISTRESS CALL	36
11.3.1	Transmitting a DSC Distress Call	36
11.3.2	Receiving a DSC Distress Call	38
11.4	ALL SHIPS CALL	38
11.4.1	Transmitting an All Ships Call	39
11.4.2	Receiving an All Ships Call	39
11.5	INDIVIDUAL CALL	39
11.5.1	Setting up the Individual / Position Call Directory	39
11.5.2	Setting up Individual Reply	41
11.5.3	Setting up Individual / Group Call Ringer	41
11.5.4	Transmitting an Individual Call	42
11.5.5	Receiving an Individual Call	44
11.6	CALL WAITING DIRECTORY	44
11.6.1	Enabling the Call Waiting Feature	44
11.6.2	Reviewing Received Calls Logged into the Call Waiting Directory	45
11.6.3	To Delete the Received Log from the "DSC Log" Directory	45
11.7	GROUP CALL	46
11.7.1	Setup a Group Call	46
11.7.2	Transmitting a Group Call	47
11.7.3	Receiving a Group Call	49
11.8	POSITION REQUEST	50
11.8.1	Setting up Position Reply	50
11.8.2	Transmitting a Position Request to Another Vessel	51
11.8.3	Receiving a Position Request	53
11.9	POSITION SEND	53
11.9.1	Transmitting a DSC Position Send Ringer	53
11.9.2	Transmitting a DSC Position Send Call	53
11.9.3	Receiving a DSC Position Send Call	55
11.10	MANUAL INPUTTING OF THE GPS LOCATION (LAT/LON)	55
12	RADIO SETUP	56
12.1	LCD CONTRAST	56
12.2	TIME OFFSET	57
12.3	TIME DISPLAY	58
12.4	SOG (SPEED OVER GROUND) UNIT	58
12.5	TRUE MAGNETIC CHANGE (NAV DISPLAY)	59
12.6	PRIORITY CHANNEL SET	59
12.7	SCAN TYPE	60
12.8	SCAN RESUME TIME	60
12.9	KEY BEEP	61
12.10	WEATHER ALERT SETUP	61
12.11	CHANNEL NAMING	62
12.12	NAMING THE RADIO OR REMOTE MIC	63
12.13	ADJUSTING THE TREBLE AND BASS	64
12.14	FOG ALERT TONE FREQUENCY	64
12.15	CALENDAR SETUP	65
13	REMOTE MIC OPERATION	68
13.1	REMOTE MIC CONTROLS	68
13.2	INTERCOM OPERATION	70
13.2.1	Communication	70
13.2.2	Calling	71
13.3	KEY ASSIGNMENT	71
13.3.1	Number of Soft Keys	71
13.3.2	Define the Soft Keys	72
13.4	EXTERNAL SPEAKER AF SELECTION	72
13.5	DSC / RADIO SETUP MODE	73
14	MAINTENANCE	74
14.1	TROUBLESHOOTING CHART	75
15	CHANNEL ASSIGNMENTS	76
16	SPECIFICATIONS	82

1 GENERAL INFORMATION

1.1 INTRODUCTION

The FURUNO **FM-4000** is a Marine VHF Radiotelephone designed for use in the frequency range of 156.025 to 163.275 MHz. The **FM-4000** can be powered with 11 to 16 VDC power and has a switchable RF output power of 1 Watt or 25 Watts.

The **FM-4000** operates on all currently allocated marine channels. Channels are switchable for use with USA, International, or Canadian regulations. Emergency CH16 can be immediately selected by pressing the red [16/9] key. NOAA weather channels can also be accessed immediately by pressing the [WX] key.

The **FM-4000** incorporates DSC (Digital Selective Calling) Class D facilities which comply with ITU-R M.493-11 (DSC Class D). Class D operation provides continuous watch on DSC CH70 even if the radio is receiving a call.

Two Remote MICs (**CMP30**, remote-control speaker/microphone with display) are available.

The main features are

- Commercial grade ITU class D DSC transceiver
- Superior receiver performance (80 dB rejection)
- 30W LoudHailer complete with listen-back and four fog horns, bells, and whistle
- 2.2-inch internal speaker produces clear, loud audio
- 2.58" x 1.28" dot matrix display
- Alphanumeric keypad allows direct entry of channel numbers or selection of most used functions
- NAV mode displays latitude/longitude, position, time, SOG, COG*
- Oversized rotary selector, volume and squelch knobs
- Programmable scan, selectable priority scan, and dual watch
- One-button access to CH16 and CH9
- Treble and bass audio tone control
- Two inputs for optional Remote MIC
- Optional voice scrambler
- Multi-station intercom
- High and low voltage warnings
- × When connected to a GPS receiver.

2 PACKING LIST

When the package containing the transceiver is first opened, please check it for the following contents:

- **FM-4000** Transceiver
- Mounting Bracket and attaching hardware including mic hook, bracket knob and screws
- Owner's Manual
- Warning Sticker
- Power Cord

3 OPTIONS

MMB-84	Flush-Mount Bracket
CMP30B/W	Remote MIC (Black/White)
CT-100	23-foot Extension Cable for Remote MIC
CVS2500	Voice Scrambler
BH-2A	Bluetooth [®] Headset
BU-1	Bluetooth [®] Master Unit
CAB-2	Charge Holder for BH-2A

4 SAFETY / WARNING INFORMATION

This radio is restricted to occupational use, work related operations only where the radio operator must have the knowledge to control the exposure conditions of its passengers and bystanders by maintaining the minimum separation distance of 0.89 m (2.92 feet). Failure to observe these restrictions will result in exceeding the FCC RF exposure limits.

Antenna Installation:

The antenna must be located at least 0.89 m (2.92 feet) away from passengers in order to comply with the FCC RF exposure requirements.

Lithium Battery:

This radio contains a lithium battery. At the end of the radio's useful life, under various state laws, it may be illegal to dispose of a lithium battery into the municipal waste stream. Check with your local solid waste officials for details about recycling options and proper disposal.

5 FCC RADIO LICENSE INFORMATION

FURUNO radios comply with the Federal Communication Commission (FCC) requirements that regulate the Maritime Radio Service.

5.1 STATION LICENSE

An FCC ship station license is no longer required for any vessel traveling in U.S. waters (except Hawaii) which is less than 20 meters in length. However, any vessel required to carry a marine radio on an international voyage, carrying an HF single sideband radiotelephone or marine satellite terminal is required to have a ship station license. FCC license forms, including applications for ship (506) and land station licenses can be downloaded via the Internet at www.fcc.gov/forms. To obtain a form from the FCC, call (888) 225-5322.

5.2 RADIO CALL SIGN

Currently the FCC does not require recreational boaters to have a Ship Radio Station License. The USCG recommends that you use your boat's registration number and the state in which it is registered.

5.3 CANADIAN SHIP STATION LICENSING

You may need a license when traveling in Canada. If you do need a license contact their nearest field office or regional office or write:

**Industry Canada
Radio Regulatory Branch
Attn: DOSP
300 Slater Street
Ottawa, Ontario
Canada, KIA 0C8**

5.4 FCC / INDUSTRY CANADA INFORMATION

The following data pertaining to the transceiver is necessary to fill out the license application.

Type Acceptance FCC Part 80
Output Power 1 Watt (low) and 25 Watts (high)
Emission 16K0G3E, 16K0G2B
Frequency Range 156.025 to 163.275 MHz
FCC Type Number K6630283X3S
Industry Canada Type Approval 511B-30283X3S

6 FCC NOTICE

NOTICE

Unauthorized changes or modifications to this equipment may void compliance with FCC Rules. Any change or modification must be approved in writing by STANDARD HORIZON.

NOTICE

This equipment has been tested and found to comply with the limits for a Class B digital device, pursuant to Part 15 of the FCC Rules. These limits are designed to provide reasonable protection against harmful interference in a residential installation. This equipment generates, uses and can radiate radio frequency energy and, if not installed and used in accordance with the instructions, may cause harmful interference to radio communications. However, there is no guarantee that interference will not occur in a particular installation. If this equipment does cause harmful interference to radio or television reception, which can be determined by turning the equipment off and on, the user is encouraged to try to correct the interference by one or more of the following measures:

- Reorient or relocate the receiving antenna.
- Increase the separation between the equipment and receiver.
- Connect the equipment into an outlet on a circuit different from that to which the receiver is connected.
- Consult the dealer or an experienced radio/TV technician for help.

7 GETTING STARTED

7.1 ABOUT VHF RADIO

The radio frequencies used in the VHF marine band lie between 156 and 158 MHz with some shore stations available between 161 and 163 MHz. The marine VHF band provides communications over distances that are essentially “line of sight” (VHF signals do not travel well through objects such as buildings, hills or trees). Actual transmission range depends much more on antenna type, gain and height than on the power output of the transmitter. On a fixed mount 25 W radio transmission expected distances can be greater than 15 miles, for a portable 5 W radio transmission the expected distance can be greater than 5 miles in “line of sight”.

7.2 SELECTING AN ANTENNA

Marine antennas are made to radiate signals equally in all horizontal directions, but not straight up. The objective of a marine antenna is to enhance the signal toward the horizon. The degree to which this is accomplished is called the antenna’s gain. It is measured in decibels (dB) and is one of the major factors in choosing an antenna. In terms of effective radiated power (ERP), antennas are rated on the basis of how much gain they have over a theoretical antenna with zero gain. A 3-foot, 3 dB gain antenna represents twice as much gain over the imaginary antenna.

Typically a 3-foot 3 dB gain stainless steel whip is used on a sailboat mast. The longer 8-foot 6 dB fiberglass whip is primarily used on powerboats that require the additional gain.

7.3 COAXIAL CABLE

VHF antennas are connected to the transceiver by means of a coaxial cable – a shielded transmission line. Coaxial cables are specified by their diameters and construction.

For runs less than 20 feet, RG-58/U, about 1/4-inch in diameter, is a good choice. For runs over 20 feet but less than 50 feet, the larger diameter RG-8X or RG-213/U should be used. Cable runs over 50 feet should use RG-8X. For installation of the connector onto the coaxial cable see the figure below.

To get your coaxial cable through a fitting and into your boat’s interior, you may have to cut off the end plug and reattach it later. You can do this if you follow the directions that come with the connector. Be sure to make good soldered connections.

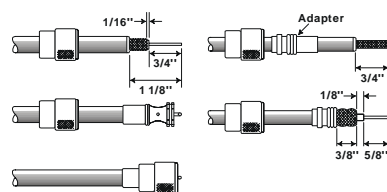

8 INSTALLATION

8.1 LOCATION

The radio can be mounted at any angle. Choose a mounting location that:

- is far enough from any compass to avoid any deviation in compass reading due to the speaker magnet (see the compass safe distances in the Safety Instructions)
- provides easy access to the front panel controls and rear connectors
- allows connection to a power source and an antenna
- has nearby space for installation of a microphone hanger
- the antenna must be mounted at least three feet from the radio

Note: To insure the radio does not affect the compass or the radio's performance is not affected by the antenna location, temporarily connect the radio in the desired location and:

- a. Examine the compass to see if the radio causes any deviation.
- b. Connect the antenna and key the radio. Check to ensure the radio is operating correctly by requesting a radio check.

8.2 OPTIONAL MMB-84 FLUSH MOUNT INSTALLATION

1. Make a rectangular template for the flush mount measuring 2.9" H x 8.1" W (72 x 205 mm).
2. Use the template to mark the location where the rectangular hole is to be cut. Confirm that the space behind the dash or panel is deep enough to accommodate the transceiver (at least six inches deep).
There should be at least 1/2 inch between the transceiver's heatsink and any wiring, cables or structures.
3. Cut out the rectangular hole and insert the transceiver.
4. Fasten the brackets to the sides of the transceiver with the lock washer nut combination so that the mounting screw base faces the mounting surface.
5. Turn the adjusting screw to adjust the tension so that the transceiver is tight against the mounting surface.

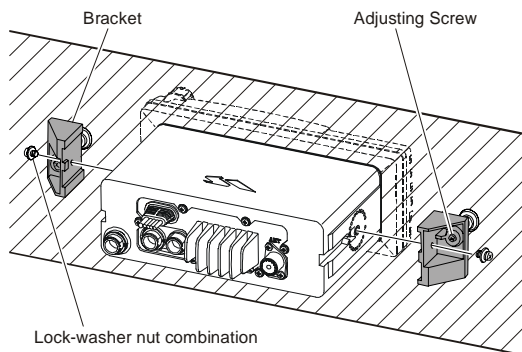

8.3 OPTIONAL CMP30 REMOTE MIC

The **CMP30** Remote MIC permits remote control of the **FM-4000**'s radio, DSC and PA/Fog functions. In addition the **FM-4000** can operate as a full function intercom system.

1. Connect the extension cable to the remote MIC eight pin connector on the rear panel, then tighten the cable nut (See Figure 3).
2. Referring to Figure 3, make a 1.2" (30 mm) hole in the wall, then insert the extension cable into this hole. Connect the gasket and mounting base to the extension cable connector using the nut.
3. Drill the four screw holes (approx. 2 mm) on the wall, then install the mounting base to the wall using four screws.

Put the rubber cap onto the nut. The installation is now complete.

NOTE

The routing cable can be cut and spliced, however care needs to be taken when reconnecting the wires to ensure water integrity.

Before cutting the cable, make sure it is not plugged into the radio. After cutting you will notice there are the following wires:

Yellow, Green, Brown, Purple, Blue, Green, Red*, Shield*

× The red and shield wires are wrapped in foil. Remove the foil, and separate the red and shield wires.

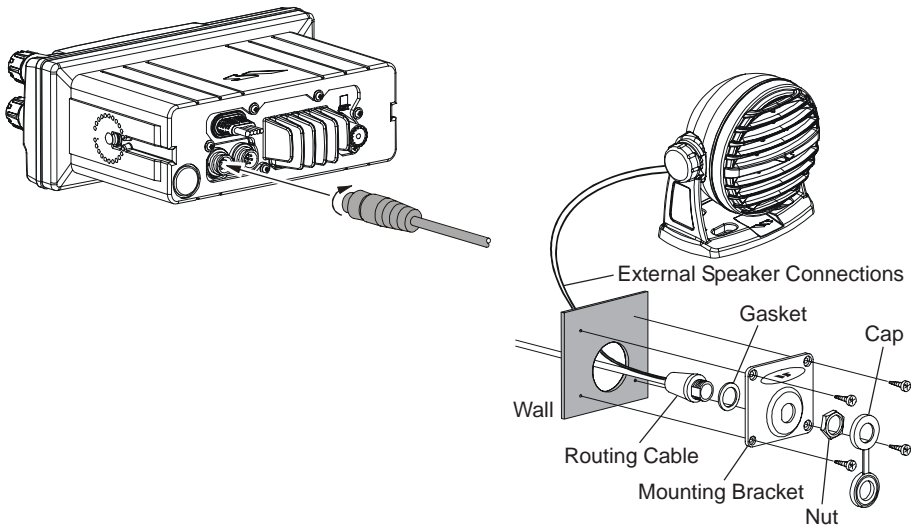

Remote MIC or External Speaker Selection

By default the internal speaker is turned on, however it can be turned off to use the external speaker, when the Remote MIC is installed.

Remote MIC procedure

1. Press and hold down the [CALL(MENU)] key until the "Radio Setup" menu appears.
2. Press the [ENT] key, then use the [▲] or [▼] key to select "Ext Speaker."
3. Press the [ENT] key.
4. Press the [▲] or [▼] key to select "Off" (External speaker off) or "On" (External speaker on).
6. Press the [ENT] key to save the selection, then press the [16/9] key to return to radio operation.

```
-Setup Menu-  
→Radio Setup  
DSC Setup  
  
Set>[ENT], Clear>[CLR]
```

```
-Radio Setup-  
Contrast  
SOG Unit  
Magnetic  
Key Beep  
Unit Name  
→Ext Speaker  
Set>[ENT], Clear>[CLR]
```

```
-EXT Speaker-  
→On  
Off  
  
Set>[ENT], Clear>[CLR]
```

8.4 ELECTRICAL CONNECTIONS

CAUTION

Reverse polarity connections will damage the radio!

Connect the power cord and antenna to the radio. Antenna and power supply connections are as follows:

1. Mount the antenna at least three feet away from the radio. At the rear of the radio, connect the antenna cable. It must have a PL259 connector.
2. Connect the red power wire to a 13.8 VDC $\pm 20\%$ power source. Connect the black power wire to a negative ground.
3. It is advisable to have a certified marine technician check the power output and the standing wave ratio of the antenna after installation.

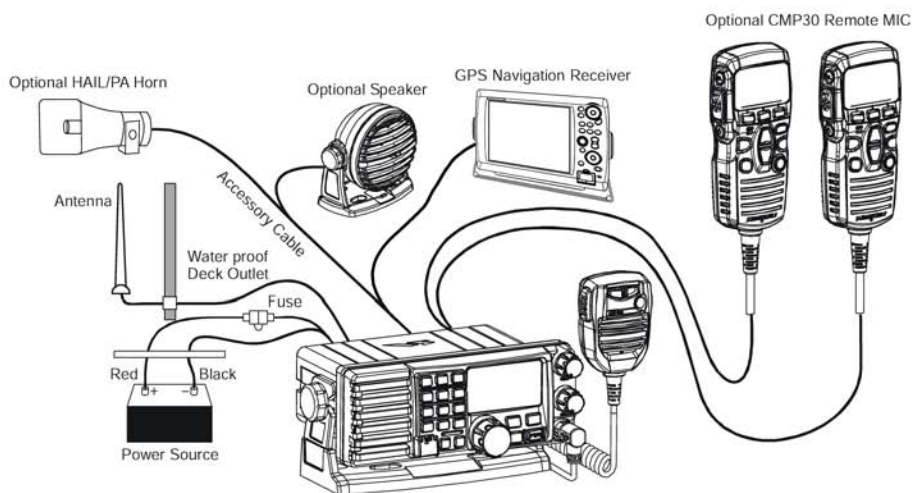

Fuse Replacement

To take out the fuse from the fuse holder, hold the both ends of the fuse holder and pull the fuse holder apart, do not bend the fuse holder. When you replace the fuse, please confirm that the fuse is tightly fixed on the metal contact located inside the fuse holder. If the metal contact holding the fuse is loose, the fuse holder may heat up.

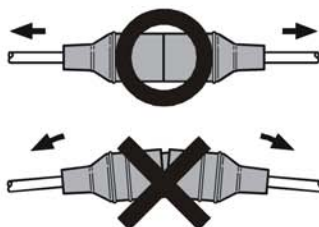

8.5 ACCESSORY CABLE

Wire Color/Description	Connection Examples
WHITE - External Speaker (+)	Connect to external 4 Ω audio speaker
SHIELD - External Speaker (-)	Connect to external 4 Ω audio speaker
RED - PA Speaker (+)	Connect to external 4 Ω PA speaker
SHIELD - PA Speaker (+)	Connect to external 4 Ω PA speaker
BLUE - NMEA Input (+)	Connect to NMEA Output (+) of GPS
GREEN - NMEA Input (-)	Connect to NMEA Output (-) of GPS
GRAY - NMEA Output (+)	Connect to NMEA Input (+) of GPS
BROWN - NMEA Output (-)	Connect to NMEA Input (+) of GPS

When connecting the PA speaker, external speaker or GPS receiver, strip off about 1 inch (2.5 cm) of the specified wire's insulation, then splice the ends together.

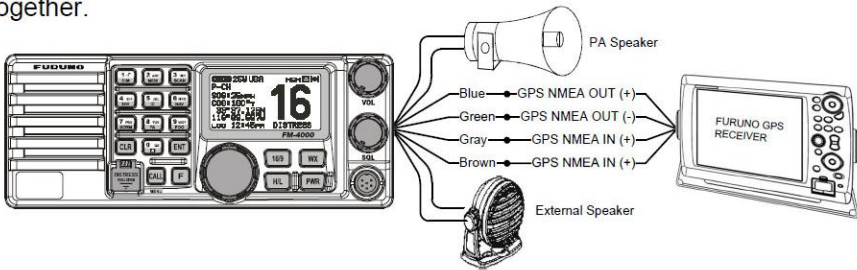

Note: In some areas powerful AM broadcast stations may be heard when in listen-back mode. In this case change the speaker wire to 2-conductor shielded audio cable. See the illustration below for connections.

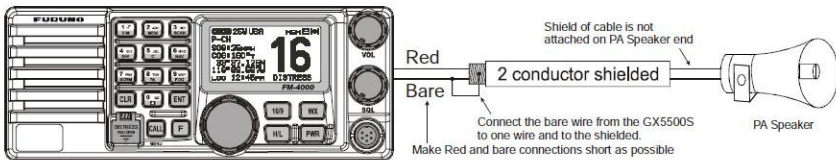

- The GPS receiver must have its NMEA output turned on and baud rate set to "4800" in the Setup menu. If there is a selection for parity, select "None".
- For further information on interfacing /setting up your GPS receiver, please refer to its Operator's Manual.
- **FM-4000** can read NMEA-0183 version 2.0 or higher.
- The NMEA supported sentences are:
 Input: GLL, GGA, RMC and GNS (RMC sentence is recommended)
 Output: DSC and DSE
 (DSC sentences to FURUNO plotter for position polling)

8.6 CHANGING THE TIME INDICATION

Set the radio to show UTC time, or local time with the offset inputted in section “8.5 CHANGING THE GPS TIME.”

1. Press and hold down the [CALL(MENU)] key until the “Radio Setup” menu appears.
2. Press the [ENT] key, then use the CHANNEL selector knob to select “Time Display”.
3. Press the [ENT] key.
4. Turn the CHANNEL selector knob to select “UTC” or “Local.”
5. Press the [ENT] key to store the selected setting.
6. Press the [CLR] key to return to the “Radio Setup” menu, then press the [CLR] key again to return to radio operation.

```
-Setup Menu-
+Radio Setup
DSC Setup

Set>[ENT], Clear>[CLR]

-Radio Setup-
Dimmer
Contrast
Time Offset
+Time Display
SDS Unit
Magnetic
Set>[ENT], Clear>[CLR]

-Time Display-
+UTC
Local

Set>[ENT], Clear>[CLR]
```

8.7 CHANGING THE COG INDICATION

GPS Course Over Ground can be shown in True or Magnetic bearing. To change the COG indication, do as follows:

1. Press and hold down the [CALL(MENU)] key until the “Radio Setup” menu appears.
2. Press the [ENT] key, then use the CHANNEL selector knob to select “Magnetic”.
3. Press the [ENT] key.
4. Turn the CHANNEL selector knob to select “Magnetic” or “True.”
5. Press the [ENT] key to store the selected setting.
6. Press the [CLR] key to return to the “Radio Setup” menu, then press the [CLR] key again to return to radio operation.

```
-Setup Menu-
+Radio Setup
DSC Setup

Set>[ENT], Clear>[CLR]

-Radio Setup-
Dimmer
Contrast
Time Offset
Time Display
SDS Unit
+Magnetic
Set>[ENT], Clear>[CLR]

-Magnetic-
Magnetic
+True

Set>[ENT], Clear>[CLR]
```

9 CONTROLS AND INDICATIONS

NOTE

This section defines each control of the transceiver. See the illustration on the next page for the location of the controls. For detailed operating instructions, see Chapter 10.

9.1 CONTROLS AND CONNECTORS

① VOLUME CONTROL (VOL/PWR)

Adjusts the audio volume level. Turn the control clockwise to increase the audio volume level.

Secondary Use

Controls the listen-back volume in the PA or Fog mode.

② SQUELCH CONTROL (SQL)

Adjust this control clockwise to set the point at which random noise on the channel does not activate the audio circuits but a received signal does. This point is called the squelch threshold. Be careful not to set the squelch too high; reception of wanted transmissions will be degraded.

③ MIC Connector

Connects to the supplied noise-canceling speaker microphone.

④ KEYPAD

[WX] Key

Immediately recalls the last-selected NOAA weather channel. Pressing the [WX] key again reverts to the previously selected working channel.

Secondary use:

Press the [WX] key while pressing and holding the [16/9] key to switch between USA, International and Canadian bands.

[PWR] Key

Turns the transceiver on and off. To turn the transceiver on, press and hold this key until the LCD turns on. To turn it off, press and hold this key until the LCD turns off. When the power is turned on, the transceiver is set to the last-selected channel.

[16/9] Key

Immediately recalls CH16. Hold down the [16/9] key to recall CH9. Press the [16/9] key again to revert to the previously selected working channel.

Secondary use:

Press the [WX] key while pressing and holding the [16/9] key to switch between USA, International and Canadian bands.

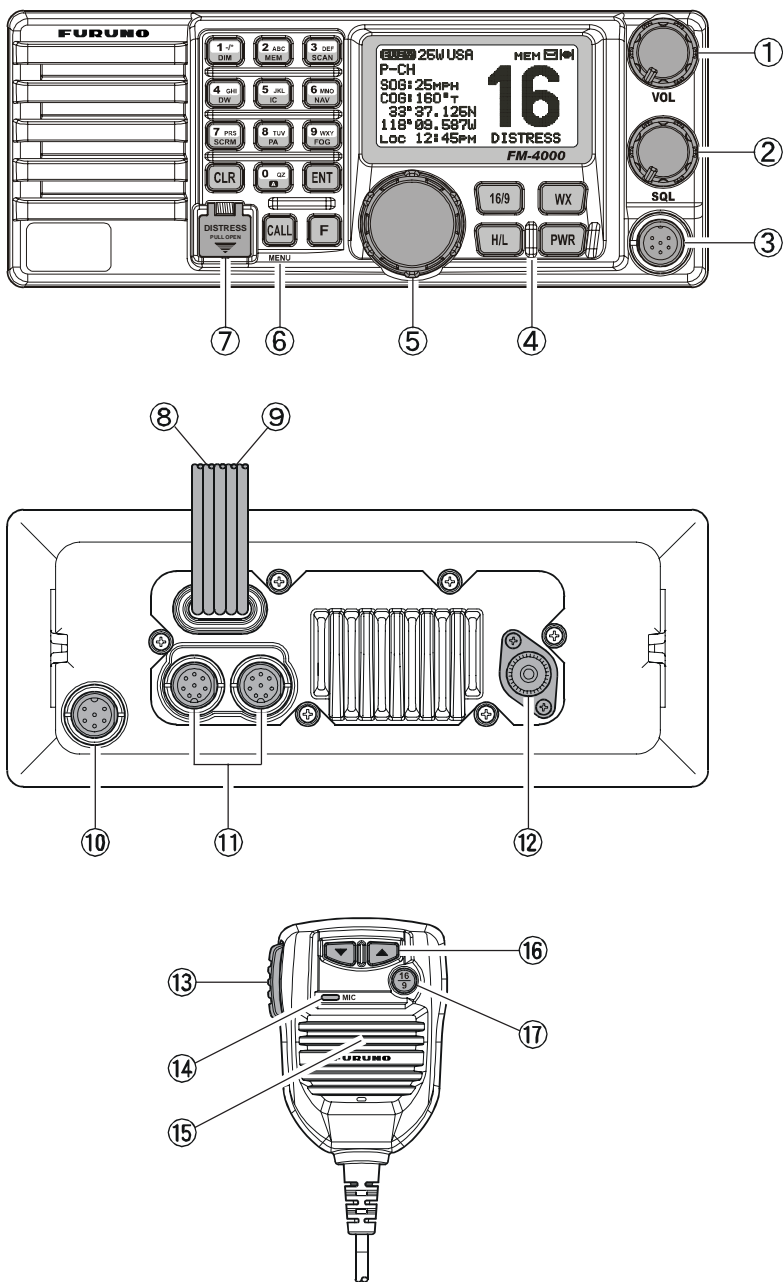

Figure 4. Controls and Connectors

[H/L] Key

Toggles between 25 W (High) and 1 W (Low) power. When the [H/L] key is pressed while the transceiver is on CH13 or CH67, the power will temporarily switch from LO to HI power until the **PTT** is released. The [H/L] key does not function on transmit inhibited and low-power only channels.

⑤ CHANNEL SELECTOR KNOB

This rotary knob selects channels and to chooses menu items (such as the DSC menu, Radio Setup and DSC Setup menu). The [UP(▲)] / [DOWN(▼)] keys on the microphone can also be used to select channels and menu items.

Secondary Use

- Press the [F] key first then press the [3(SCAN)] key, and turn the **CHANNEL** selector knob while holding down the [3(SCAN)] key to confirm memory channels for scanning.
- Adjusts the PA output level while in PA/FOG mode.

⑥ KEYPAD

[1(DIM)] Key

When in the radio mode, this key directly inputs the digit “1” in a channel number.

Secondary use

Press the [F] key first, then press the [1(DIM)] key to access the LCD Dimmer menu. See section “**10.16 LCD DIMMER**” for details.

[2(MEM)] Key

When in the radio mode, this key directly inputs the digit “2” in a channel number.

Secondary use

Press the [F] key first then press the [2(MEM)] key to memorize the selected channel into the transceiver scan memory for scanning. Repeating the same procedure ([F] → [2(MEM)]), deletes the channel from the scan memory. See section “**10.13 SCANNING**” for details.

[3(SCAN)] Key

When in the radio mode, this key directly inputs the digit “3” in a channel number.

Secondary use (*Depends on the transceiver version*)

Press the [F] key first then press the [3(SCAN)] key to start and stop the scanning of programmed channels. See section “**10.13 SCANNING**” for details.

[4(DW)] Key

When in the radio mode, this key directly inputs the digit “4” in a channel number.

Secondary use

Press the [F] key first then press the [4(DW)] key to scan for voice communications on the priority channel and another selected channel until a signal is received on either channel (Dual Watch). See section “**10.12 DUAL WATCH (TO CH16)**” for details.

[5(IC)] Key

When in the radio mode, this key directly inputs the digit “5” in a channel number.

Secondary use

Press the [F] key first then press the [5(IC)] key, when the optional Remote MIC is connected, to activates Intercom function between radio and Remote MIC. See section “**10.17 INTERCOM OPERATION**” for details.

[6(NAV)] Key

When in the radio mode, this key directly inputs the digit “6” in a channel number.

Secondary use

Press the [F] key first then press the [6(NAV)] key, and the LCD displays NAV GPS Data; Time, SOG (Speed Over Ground), and COG (Course Over Ground). Requires a GPS receiver, connected to the **FM-4000** with the accessory cable. See section “**8.5 ACCESSORY CABLE**” for details.

[7(SCRM)] Key

When in radio mode, this key directly inputs the digit “7” in a channel number.

Secondary use

Press the [F] key first then press the [7(SCRM)] key, when the optional **CVS2500** Voice Scrambler Unit is installed, to operate the Voice Scrambler function. See section “**10.18 VOICE SCRAMBLER**” for details.

[8(PA)] Key

When in the radio mode, this key directly inputs the digit “8” in a channel number.

Secondary use

Press the [F] key first then press the [8(PA)] key to operate the 30 Watt PA function. See section “**10.14 PA/FOG OPERATION**” for details.

[9(FOG)] Key

When in the radio mode, this key directly inputs the digit “9” in a channel number.

Secondary use

Press the [F] key first then press the [9(FOG)] key to operate the Fog Horn function. See section “10.14 PA/FOG OPERATION” for details.

[0] Key

When in the radio mode, this key directly inputs the digit “0” in a channel number.

[CLR] Key

Cancels the menu selection and/or key input.

[ENT] Key

Confirms the menu selection and/or key input.

[CALL(MENU)] Key

Opens the DSC OPERATION menu. The “Individual Call,” “Group Call,” and “All Ship Call” functions can be accessed from the DSC OPERATION menu.

Secondary use

Press and hold the [CALL(MENU)] key to access the “Radio Setup” menu (see section “12 RADIO SETUP”) or “DSC Setup” menu (see section “11 DIGITAL SELECTIVE CALLING”).

RADIO SETUP menu	DSC SETUP menu
Contrast	Individual Directory
Time Offset	Individual Reply
Time Display	Individual Ack
SOG Unit	Individual Ringer
Magnetic	Group Directory
Priority CH	Position Reply
SCAN Type	Position Input*
SCAN Resume	DSC Beep
Key Beep	User MMSI
Weather Alert	*: Shown when a GPS receiver is not connected.
CH Name	
Unit Name	
Tone Control	
FOG Frequency	
Calendar	

[F] Key

Press the [F] key to activate the “Alternate” key function.

⑦ [DISTRESS] Key

Send a DSC Distress Call. For details, see section “11.3.1 Transmitting a DSC Distress Call.”

⑧ **ACCESSORY CONNECTION CABLE**

Connects the **FM-4000** to a GPS receiver, a PA speaker, and an external speaker.

⑨ **DC INPUT CABLE**

Connects the radio to a DC power supply capable of delivering 12 to 16 V DC.

⑩ **FRONT PANEL REMOTE MIC Connector**

Connects the supplied Hand Microphone if desired. This connector is used to remote the front panel speaker MIC. This allows the connection of two MICs, one at the front panel and one on the rear panel.

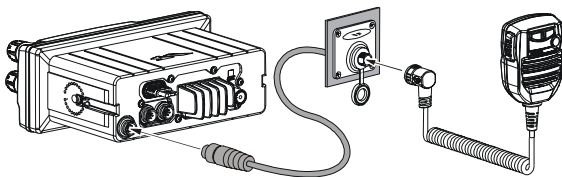

⑪ **REMOTE MIC CONNECTORS**

Connects the **FM-4000** to the Remote MIC. See section “**13 REMOTE MIC OPERATION**” for details.

⑫ **ANTENNA JACK**

Connects an antenna to the transceiver. Use a marine VHF antenna with an impedance of 50 ohms.

⑬ **PTT (Push-To-Talk) SWITCH**

Keys the transmitter when the transceiver is in the radio mode. If the transceiver is in the Intercom mode (between the Remote MIC and the **FM-4000**), it activates the **FM-4000**'s microphone for voice communications.

⑭ **MICROPHONE**

Transmits the voice message with reduction of background noise, using Clear Voice Noise Reduction Technology.

⑮ **MICROPHONE SPEAKER**

The same audio heard through internal radio speaker is heard through microphone speaker.

⑯ **[UP(▲)] / [DOWN(▼)] KEYS**

These keys function the same as the **CHANNEL** selector knob on the front panel of the transceiver.

⑰ **[16/9] Key**

Immediately recalls CH16. Press and hold the **[16/9]** key to recall CH9. Press the **[16/9]** key again to revert the radio to the previously selected channel.

10 BASIC OPERATION

10.1 PROHIBITED COMMUNICATIONS

The FCC prohibits the following communications:

- False distress or emergency messages;
- Messages to “any boat” except in emergencies and radio tests;
- Messages to or from a vessel on land;
- Transmission while on land;
- Obscene, indecent, or profane language (potential fine of \$10,000).

10.2 RECEPTION

1. After the transceiver has been installed, ensure that the power supply and antenna are properly connected.
2. Press and hold the **PWR** key until the radio turns on.
3. Turn the **SQL** knob fully counterclockwise. This state is known as “squelch off”.
4. Rotate the **VOL** knob clockwise until noise or audio from the speaker is at a comfortable level.
5. Turn the **SQL** knob clockwise until the random noise disappears. This state is known as the “squelch threshold.”
6. Turn the **CHANNEL** selector knob to select the desired channel. Refer to the channel chart on page 91 for available channels.
7. The keypad on the front panel may be used to directly select channels. For example, to select CH68:
 1. Press [**6(NAV)**].
 2. Press [**8(PA)**].
 3. Press [**ENT**].In the USA and Canadian modes, press and hold down the [**0**] key to select the “A” channel. Example to select CH22A:
 1. Press [**2(MEM)**].
 2. Press [**2(MEM)**].
 3. Press [**0**] until “A” appears to the right of the channel number.
 4. Press [**ENT**].
8. When a message is received, adjust the volume to the desired listening level. The “**BUSY**” indicator appears if the channel is busy.

10.3 TRANSMISSION

1. Perform steps 1 through 6 in 10.2 RECEPTION.
2. Before transmitting, monitor the channel to ensure it is clear.
THIS IS AN FCC REQUIREMENT!
3. Press the **PTT** (push-to-talk) switch, and the indication “**T X**” appears.
4. Speak slowly and clearly into the microphone.
5. When you have finished transmitting, release the **PTT** switch.

NOTE

This is a noise-canceling microphone. Position the oval slot labeled “**MIC**” within one-inch (2.5 cm) from your mouth for optimum performance.

10.4 TRANSMIT TIME - OUT TIMER (TOT)

When the **PTT** switch on the microphone is held down, transmit time is limited to five minutes. This limits unintentional transmissions due to a stuck microphone. About 10 seconds before automatic transmitter shutdown, a warning beep sounds from the speaker(s). The transceiver will automatically go to the receive mode, even if the **PTT** switch is continually held down. Before transmitting again, the **PTT** switch must first be released and then pressed again.

10.5 SIMPLEX/DUPLEX CHANNEL USE

Refer to the VHF MARINE CHANNEL CHART (page 77) for instructions on use of simplex and duplex channels.

NOTE

All channels are factory-programmed in accordance with FCC (USA), Industry Canada (Canada), and International regulations. Mode of operation cannot be altered from simplex to duplex or vice-versa.

10.6 USA, CANADA, AND INTERNATIONAL MODE

1. To change the mode, hold the [**16/9**] key, then press the [**WX**] key. The mode changes from USA to International to Canadian with each press of the [**WX**] key.
“**USA**” appears for the USA mode, “**INTL**” for the International mode, and “**CAN**” for the Canadian mode.
2. See the VHF MARINE CHANNEL CHART (page 77) for allocated channels in each mode.

10.7 NOAA WEATHER CHANNELS

1. To receive a NOAA (National Oceanic and Atmospheric Administration) weather channel, press the **[WX]** key. The transceiver will go to the last-selected weather channel.
2. Turn the **CHANNEL** selector knob on the radio or **[UP(▲)]** / **[DOWN(▼)]** keys on the microphone to select a different NOAA weather channel.
3. To exit from the NOAA weather channels, press the **[WX]** key. The transceiver returns to the channel it was on prior to a weather channel.

10.7.1 NOAA Weather Alert

In the event of extreme weather disturbances, such as storms and hurricanes, the NOAA sends a weather alert accompanied by a 1050 Hz tone and subsequent weather report on one of the NOAA weather channels. When the Weather Alert feature is enabled (see section “**12.10 WEATHER ALERT (ON/OFF)**”), the transceiver is capable of receiving this alert if you do the following:

1. Program NOAA weather channels into the transceiver’s memory for scanning. Program by the same procedure as for regular channels, referring to section “**10.13.2 Memory Scanning (M-SCAN)**.”
2. Press the **[SCAN]** key once to start memory scanning.
3. The programmed NOAA weather channels will be scanned along with the regular-programmed channels. However, scanning will not stop on a normal weather broadcast unless a NOAA alert is received.
4. When an alert is received on a NOAA weather channel, scanning will stop and the transceiver will emit a loud beep to alert the user to a NOAA broadcast.
5. Press the **[WX]** key to stop the alert tone and receive the weather report.

NOTE

If the **[WX]** key is not pressed at step 5, the alert tone will be emitted for five minutes and then the weather report will be received.

NOTE

The Weather Alert feature is also engaged while the transceiver is receiving on one of the NOAA weather channels.

10.7.2 NOAA Weather Alert Testing

NOAA tests the alert system every Wednesday between 11AM and 1PM. To test the **FM-4000**’s NOAA Weather feature at that time, setup as directed in section “**10.7.1 NOAA Weather Alert**” and confirm that you receive the alert.

10.8 EMERGENCY (CH16 USE)

CH16 is known as the Hail and Distress channel. An emergency may be defined as a threat to life or property. In such instances, be sure the transceiver is on and set it to CH16. Then do as follows:

1. Press the microphone push-to-talk switch and say “**Mayday, Mayday, Mayday**. This is _____, _____, _____” (your vessel’s name).
2. Then repeat once: “**Mayday**, _____” (your vessel’s name).
3. Now report your position in latitude/longitude, or by giving a true or magnetic bearing (state which) to a well-known landmark such as a navigation aid or geographic feature such as an island or harbor entry.
4. Explain the nature of your distress (sinking, collision, aground, fire, heart attack, life-threatening injury, etc.).
5. State the kind of assistance you desire (pumps, medical aid, etc.).
6. Report the number of persons aboard and condition of any injured.
7. Estimate the present seaworthiness and condition of your vessel.
8. Give your vessel’s description: length, design (power or sail), color and other distinguishing marks. The total transmission should not exceed one minute.
9. End the message by saying “**OVER**”. Release the microphone push-to-talk and listen.
10. If there is no answer, repeat the above procedure. If there is still no response, try another channel.

10.9 CALLING ANOTHER VESSEL (CH16 OR CH9)

Channel 16 may be used for initial contact (hailing) with another vessel. However, its most important use is for emergency messages. This channel must be monitored at all times except when actually using another channel. It is monitored by the U.S. and Canadian Coast Guards and by other vessels. **Use of CH16 for hailing must be limited to initial contact only.** Calling should not exceed 30 seconds, but may be repeated three times at 2-minute intervals. In areas of heavy radio traffic, congestion on CH16 resulting from its use as a hailing channel can be reduced significantly in U.S. waters by using CH9 as the initial contact (hailing) channel for non-emergency communications. Here, also, calling time should not exceed 30 seconds but may be repeated three times at 2-minute intervals.

Prior to making contact with another vessel, refer to the channel charts in this manual, then select an appropriate channel for communications after initial contact. For example, CH68 and CH69 of the U.S. VHF charts are some of the channels available to non-commercial (recreational) boaters. Monitor your desired channel in advance to make sure you will not be interrupting other traffic,

and then go back to either CH16 or CH9 for your initial contact.

When the hailing channel (16 or 9) is clear, state the name of the other vessel you wish to call and then **“this is”** followed by the name of your vessel and your Station License (Call Sign). When the other vessel returns your call, immediately request another channel by saying **“go to,”** the number of the other channel, and **“over.”** Then switch to the new channel. When the new channel is not busy, call the other vessel.

After a transmission, say **“over,”** and release the microphone’s push-to-talk (PTT) switch. When all communication with the other vessel is completed, end the last transmission by stating your Call Sign and the word **“out.”** Note that it is not necessary to state your Call Sign with each transmission, only at the beginning and end of the contact.

Remember to return to CH16 when not using another channel. Some radios automatically monitor CH16 even when set to other channels or when scanning.

10.10 MAKING TELEPHONE CALLS

To make a radiotelephone call, use a channel designated for this purpose. The fastest way to learn which channels are used for radiotelephone traffic is to ask at a local marina. Channels available for such traffic are designated **Public Correspondence** channels on the channel charts in this manual. Some examples for USA use are Channels 24, 25, 26, 27, 28, 84, 85, 86, and 87. Call the marine operator and identify yourself by your vessel’s name. The marine operator will then ask you how you will pay for the call (telephone credit card, collect, etc.) and then link your radio transmission to the telephone lines.

The marine telephone company managing the VHF channel you are using may charge a link-up fee in addition to the cost of the call.

10.11 OPERATING ON CHANNELS 13 AND 67

CH13 is used at docks and bridges and by vessels maneuvering in port. Messages on this channel must concern navigation only, such as meeting and passing in restricted waters.

CH67 is used for navigational traffic between vessels.

By regulation, power is normally limited to 1 Watt on these channels. Your radio is programmed to automatically reduce power to this limit on these channels. However, in certain situations it may be necessary to temporarily use a higher power. See page 18 ([H/L] key) for how to temporarily override the low-power limit on these two channels.

10.12 DUAL WATCH (TO CH16)

1. Adjust the **SQL** knob until the background noise disappears.
2. Select the channel you wish to dual watch with CH16.
3. Press the **[F]** key followed by the **[4(DW)]** key. The display will scan between CH16 and the channel that was selected in step 2.

If a transmission is received on the channel selected in step 2, the **FM-4000** watches it and CH16.

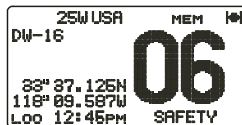

4. To stop Dual Watch, press the **[F]** key followed by the **[4(DW)]** key again.

10.13 SCANNING

Scanning allows the user to select the scan type from Memory scan or Priority scan. "Memory scan" scans the channels that were programmed into memory. "Priority scan" scans the channels programmed in memory with the priority channel.

10.13.1 Selecting the Scan Type

1. Press and hold down the **[CALL(MENU)]** key until the "Radio Setup" menu appears.
2. Press the **[ENT]** key, then use the **CHANNEL** selector knob to select "SCAN Type".
3. Press the **[ENT]** key.
4. Turn the **CHANNEL** selector knob to select "Priority SCAN" or "Memory SCAN."
5. Press the **[ENT]** key to store the selected setting.
6. Press the **[CLR]** key to return to the "Radio Setup" menu, then press the **[CLR]** key again to return to radio operation.

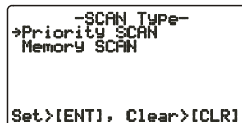
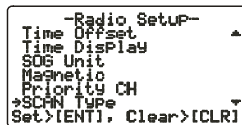
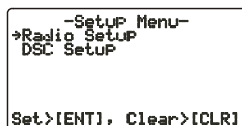

10.13.2 Memory Scanning (M-SCAN)

1. Adjust the **SQL** knob until background noise disappears.
2. Use the **CHANNEL** selector knob to select the channel to scan. Press the **[F]** key followed by the **[2(MEM)]** key. "MEM" appears on the LCD, which indicates that the channel is programmed into the transceiver's memory.
3. Repeat step 2 to select other channels to scan.
4. To DELETE a channel from the transceiver's memory, select the channel then press the **[F]** key followed by the **[2(MEM)]** key. "MEM" disappears from the LCD.
5. To start scanning, press the **[F]** key followed by the **[3(SCAN)]** key, "M-SCAN" appears on the LCD. Scanning will proceed from the lowest to

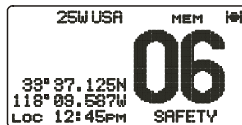

the highest programmed channel number and will stop on a channel when a transmission is received.

- The channel number will blink during reception.
- To stop scanning, press the [CLR], [16/9], or [WX] key.

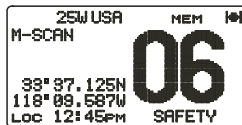

10.13.3 Priority Scanning (P-SCAN)

In the default setting, Channel 16 is set as the priority channel. You may change the priority channel to the desired channel from CH16 on the Radio Setup menu. See section “10.13.1 Selecting the Scan Type,” and “12.6 PRIORITY CHANNEL SET.”

- Adjust the **SQL** knob until background noise disappears.
- Use the **CHANNEL** selector knob to select the channel to scan. Press the [F] key followed by the [2(MEM)] key. “MEM” appears on the display, which indicates that the channel is programmed into the transceiver’s memory.
- Repeat step 2 to select all the channels to scan.
- To DELETE a channel from the transceiver’s memory, select the channel then press the [F] key followed by the [2(MEM)] key. “MEM” is removed from the display.
- To start priority scanning, press the [F] key followed by the [3(SCAN)] key. “P-SCAN” appears on the LCD. Scanning will proceed between the memorized channels and the priority channel. The priority channel will be scanned after each programmed channel.
- To stop scanning, press the [CLR], [16/9], or [WX] key.

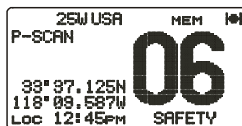
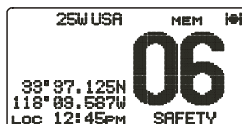

You may change the scan resume time in the Radio Setup menu. See section “12.8 SCAN RESUME TIME.”

10.14 PA/FOG OPERATION

The **FM-4000** has a 30W Hailer that can be used with any 4 Ohm PA horn. When in the Hail mode, the PA speaker listens back (acts as a microphone and sends sound to the front panel speaker and the speaker MIC) through the PA horn speaker which provides two-way communications through the PA horn speaker.

NOTE

Before entering the PA or Fog mode, the **FM-4000** receives on the last-selected VHF channel to receive DSC calls.

NOTE

In some areas powerful AM broadcast stations may be heard when in the listen-back mode. In this case change the speaker wire to 2-conductor shielded audio cable. See section “**8.5 ACCESSORY CABLE.**”

PA Hail mode:

PA Hail mode allows the transceiver to be used as a power hailer when a HAIL/PA speaker is installed. The PA Hail mode has a listen-back feature which provides two-way communication through the HAIL/PA speaker.

Fog Horn mode:

Automatic signaling is transmitted through the HAIL/PA speaker. When the Fog Horn, Bells or Whistle signal is not being outputted, the **FM-4000** listens back through the connected PA Horn speaker.

10.14.1 Operating the PA Hail mode

1. Press the [F] key followed by the [2(MEM)] key to activate the PA Hail mode.
2. Press the **PTT** switch to speak through the HAIL/PA speaker.

Rotate the **CHANNEL** selector knob to control the AF output level. The AF output level can be set from 0 to 30 watts.

3. When the fog signal is not outputted, rotate the **VOL** knob to adjust the listen-back volume.
4. To exit the PA Hail mode, press the [CLR] key.

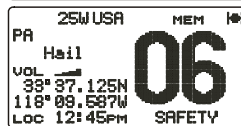
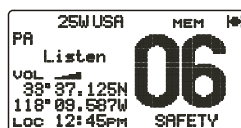

10.14.2 Operating the Fog Horn mode

Operator can select from Underway, Stop, Sail, Tow, Aground, Anchor, Horn and Siren. Refer to the Fog Horn Timing Chart on the next page.

1. Press the [F] key followed by the [9(FOG)] key.
2. Turn the **CHANNEL** selector knob to select one of the eight functions described above.
3. Press the [ENT] key.
4. On the Horn and Siren modes, press the PTT switch to activate the tone through the HAIL/PA speaker. Rotate the **CHANNEL** selector knob to control the AF output level. The AF output level can be set from 0 to 30 watts.
5. When the fog signal is not outputted, rotate the **VOL** knob to adjust the listen-back volume.
6. To exit the Fog Horn mode, press the [CLR] key.

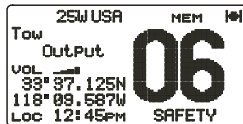

10.15 DISPLAYING SOG AND COG INFORMATION

The transceiver has the ability to display the time, SOG and COG data, as well as the vessel's position (LAT/LON), when connected to a GPS receiver.

1. Press the [F] key followed by the [6(NAV)] key to display SOG and COG information.
2. To hide SOG and COG information, press the [F] key followed by the [6(NAV)] key again.



10.16 LCD DIMMER

You can adjust the LCD dimmer as follows:

1. Press the [F] key followed by the [1(DIM)] key to enable adjustment of the backlight intensity.
2. Turn the **CHANNEL** selector knob to select the desired backlight intensity.
3. Press the [CLR] key to return to "Radio" mode.

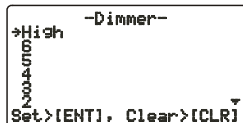

FOG HORN TIMING CHART

TYPE	PATTERN	USAGE
UNDERWAY	<p>One 5-second blast every 120 seconds.</p>	Motor vessel underway and making way.
STOP	<p>Two 5-second blasts (separated by 2 seconds) every 120 seconds.</p>	Motor vessel underway but stopped (not making way).
SAIL	<p>One 5-second blast followed by two 1-second blasts (separated by 2 seconds) every 120 seconds.</p>	Sailing vessel underway, fishing vessel (underway or anchored), vessel not under command, a vessel restricted in her ability to maneuver (underway or at anchor), or a vessel towing or pushing another ahead.
TOW	<p>One 5-second blast followed by three 1-second blasts (separated by 2 seconds) every 120 seconds.</p>	Vessel under tow (manned).
AGROUND	<p>One 11-second ring every 60 seconds.</p>	Vessel is aground.
ANCHOR	<p>One 5-second ring every 60 seconds.</p>	Vessel is at anchor.

10.17 INTERCOM OPERATION

Connecting the optional **CMP30** Remote MIC to the **FM-4000** allows Intercom communications. See section “13.2 INTERCOM OPERATION” for operation of the **CMP30**.

10.17.1 Communication

1. Press and hold the [5(IC)] key while in the “Radio” mode to change to the “Intercom” mode.
2. If your **FM-4000** is equipped two Remote MICs, use the **CHANNEL** selector knob select the one of use (**RAM1**, **RAM2**, or **ALL**), then press the [ENT] key.
3. When the “Intercom” feature is activated, “Intercom” appears on the **FM-4000** and **CMP30**.
4. Press the **PTT** switch. “Talk” appears on the display.

NOTE: A warning beep is emitted when the **FM-4000** microphone’s **PTT** switch is pressed while the Remote MIC’s **PTT** switch is pressed.
5. Speak slowly and clearly into the microphone, holding the microphone about 1/2 inch away from your mouth.
6. When finished, release the **PTT** switch.
7. Press the [CLR] key to return to the “Radio” mode.



(FM-4000 display)



(CMP30 display)

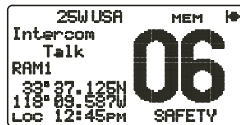

(FM-4000's PTT switch is pressed)



(CMP30's PTT switch is pressed)

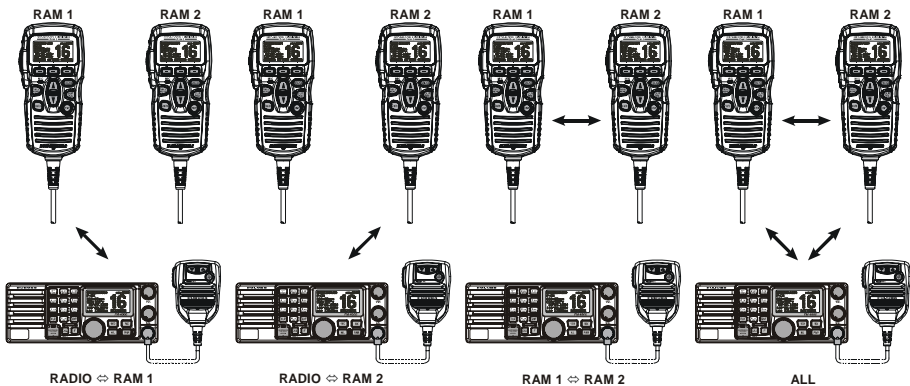
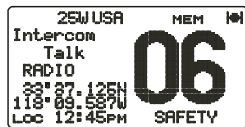

10.17.2 Calling

Hold down the [5(IC)] key when the “Intercom” mode is activated to send a calling beep to the Remote MIC.

NOTE

When both Remote MICs are set to the Intercom mode, the **FM-4000** is temporarily disabled until both Remote MICs exit the Intercom mode.

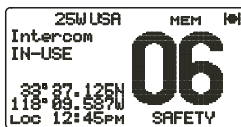

10.18 VOICE SCRAMBLER

If privacy of communications is desired, an optional **CVS2500** four-code voice scrambler (VS) can be installed in the transceiver. Contact your dealer to have the **CVS2500** installed.

1. Turn the **CHANNEL** selector knob to select the channel to be scramble.
Note: The voice scrambler is inoperative on CH16 and CH70.
2. Press the [F] key followed by the [7(SCRM)] key to activate the voice scrambler. “VS” and scrambler number (“0,” “1,” “2,” or “3”) appear.
3. Press the [F] key, then press and hold down the [7(SCRM)] key until the “Scrambler” menu appears.
4. Turn the **CHANNEL** selector knob to change the scrambler code. The scrambler code can be set from “0” to “3.”
5. Press the [ENT] key to save the scrambler code and return to the radio operation mode (with voice scrambler).
6. Monitor the channel before transmitting.
7. To disable the voice scrambler, press the [F] key followed by the [7(SCRM)] key again. “VS” and scrambler number (“0,” “1,” “2,” or “3”) disappear.

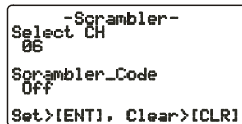
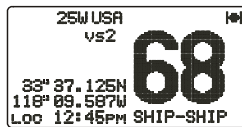

11 DIGITAL SELECTIVE CALLING

11.1 GENERAL

WARNING

This radio is designed to generate a digital maritime distress and safety call to facilitate search and rescue. To be effective as a safety device, this equipment must be used only within communication range of a shore-based VHF marine CH70 distress and safety watch system. The range of the signal may vary but under normal conditions should be approximately 20 nautical miles.

NOTE

A DSC warning sticker is included with the **FM-4000**. To comply with FCC regulations, this sticker must be mounted in a location that can be easily viewed from the location of the **FM-4000**.

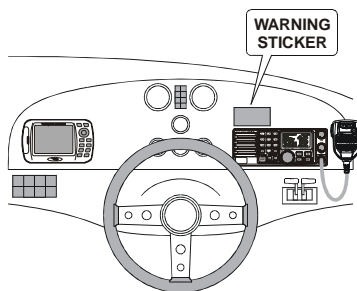

Digital Selective Calling is a semi-automated method of establishing a radio call. DSC has been designated by the International Maritime Organization (IMO) as an international standard for establishing VHF, MF and HF radio calls. It has also been designated as a part of the Global Maritime Distress and Safety System (GMDSS). It is planned that DSC will eventually replace aural watches on distress frequencies and will be used to announce routine and urgent maritime safety information broadcasts.

This new system allows mariners to instantly send a Distress call with GPS position (when connected to the transceiver) to the US Coast Guard and other vessels within range of the transmission. DSC will also allow mariners to initiate or receive Distress, Urgency, Safety, Routine, Position Request, Position Send, and Group calls to or from another vessel equipped with a DSC transceiver.

11.2 MARITIME MOBILE SERVICE IDENTITY (MMSI)

11.2.1 What is an MMSI?

An MMSI is a nine-digit number used on marine transceivers capable of using DSC. This number is used like a telephone number to selectively call other vessels.

THIS NUMBER MUST BE PROGRAMMED INTO THE RADIO TO OPERATE THE DSC FUNCTIONS.

How can I obtain an MMSI assignment?

In the USA, visit the following websites to register:

<http://www.boatus.com/mmsi/> or

http://seatow.com/boating_safety/mmsi.asp

In the Canada, visit

[http://strategis.ic.gc.ca/epic/site/smt-gst.nsf/vwapj/cpc_2307e.pdf/\\$FILE/cpc_2307e.pdf](http://strategis.ic.gc.ca/epic/site/smt-gst.nsf/vwapj/cpc_2307e.pdf/$FILE/cpc_2307e.pdf)

11.2.2 Programming the MMSI

WARNING

An MMSI can be inputted only once. Therefore **please be careful not to input the incorrect MMSI number.** If the user needs to change the MMSI number after it has been entered, the radio will have to be returned to the factory.

1. Press and hold down the [CALL(MENU)] key until the “Radio Setup” menu appears.
2. Turn the CHANNEL selector knob to the left to select the “DSC Setup” menu.
3. Press the [ENT] key, then use the CHANNEL selector knob to select “User MMSI.”
4. Press the [ENT] key.
5. Turn the CHANNEL selector knob or press the [UP(▲)] / [DOWN(▼)] key on the microphone to select the first number of your MMSI, then press the [ENT] key to go to the next number.
6. Repeat step 5 to set your MMSI (nine digits).
7. When finished programming the number, press and hold the [ENT] key. A confirmation message appears on the display. Set your MMSI again, then press and hold the [ENT] key.
8. Press the [ENT] key to store the number in the memory.
9. Press the [CLR] key twice to return to the “Radio Setup” menu, then press the [CLR] key again to return to radio operation.

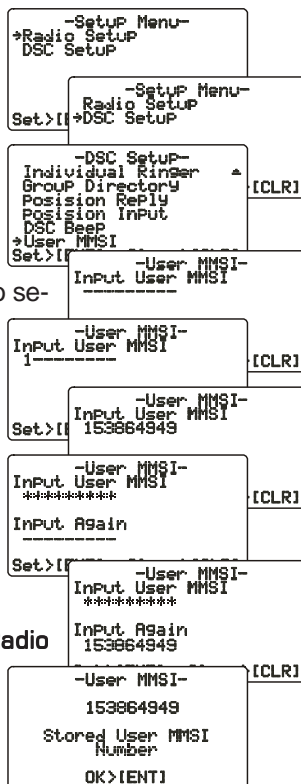

11.3 DSC DISTRESS CALL

The **FM-4000** is capable of transmitting and receiving DSC distress messages to all DSC radios. The **FM-4000** may be connected to a GPS receiver to also transmit the latitude and longitude of your vessel.

11.3.1 Transmitting a DSC Distress Call

NOTE

To transmit a DSC Distress call, an MMSI number must be programmed. See section “**11.2.2 Programming the MMSI.**”

In order for your ship’s location to be transmitted a GPS receiver must be connected to the **FM-4000**. See section “**8.5 ACCESSORY CABLE.**”

1. Lift the red spring-loaded DISTRESS cover, then the [DISTRESS] key. The “DISTRESS ALERT” menu appears on the LCD.
2. Press and hold the [DISTRESS] key. The radio’s display counts down (5-4-3-2-1) and then the Distress call is transmitted. The backlight of the LCD and keypad flash while the radio’s display is counting down.
3. When the distress signal is sent, CH70 and “ ” icon appear on the LCD.
4. The transceiver “shadow-watches” for a transmission between CH16 and CH70 until an acknowledgment signal is received. “DISTRESS” and “WAITING” appear on the LCD.
5. If an acknowledgment is received, select CH16 and advise your distress situation.
6. If no acknowledgment is received, the Distress call is repeated in 4-minute intervals until an acknowledgment is received.
7. When a DSC Distress acknowledgment is received, a distress alarm sounds and CH16 is automatically selected. The LCD shows the MMSI of the ship responding to your distress.
RECEIVED ACK: Acknowledgment signal is received.
RECEIVED RLY: Relay signal is received from another vessel or coast station.
8. To cancel the DSC distress alarm signal from the speaker, press any key.

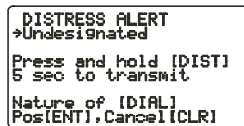

DISTRESS ALERT
*Undesignated
Press and hold [DIST]
5 sec to transmit
Nature of [DIAL]
Pos[ENT], Cancel [CLR]

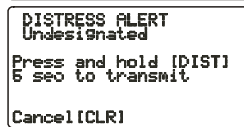

DISTRESS ALERT
Undesignated
Press and hold [DIST]
5 sec to transmit
Cancel [CLR]

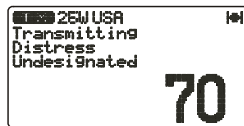

 25W USA
Transmitting
Distress
Undesignated
70

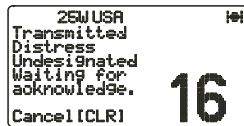

25W USA
Transmitted
Distress
Undesignated
Waiting for
acknowledge.
Cancel [CLR]
16

Transmitting a DSC Distress Alert with Nature of Distress

The **FM-4000** is capable of transmitting a DSC Distress Alert with the following “Nature of Distress” categories:

Undesignated, Fire, Flooding, Collision, Grounding, Capsizing, Sinking, Adrift, Abandoning, Piracy, MOB

1. Lift the red spring-loaded **DISTRESS** key, then the [**DISTRESS**] key to show the “**DISTRESS ALERT**” menu.
2. Turn the **CHANNEL** selector knob to select the desired nature of distress category.
3. When the **FM-4000** is connected to a GPS receiver, skip to step 4.

When the **FM-4000 is not** connected to a GPS receiver, you may send the latitude/longitude of your vessel manually, if desired.

- a. Press the [**ENT**] key twice. The display looks like the illustration at the right.
- b. Enter your local UTC time, then press the [**ENT**] key.
- c. Enter the latitude/longitude of your vessel, then press the [**ENT**] key. To select North (N) press the [**6(NAV)**] key, South (S) press the [**7(SCRM)**] key, East (E) press the [**3(SCAN)**] key or West (W) press the [**9(FOG)**] key.
- d. To store the data entered, press and hold the [**ENT**] key.

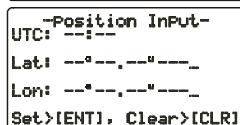
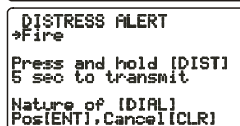
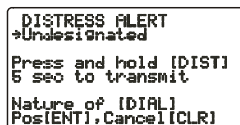

4. Press and hold the [**DISTRESS**] key. The radio’s display counts down (5-4-3-2-1) and then the distress call is transmitted. The backlight of the LCD and keypad flash during the countdown.
5. When the distress signal is sent, CH70 and “” icon appear on the LCD.
6. The transceiver will watch for a DSC acknowledgment transmission on CH70 and also receive calls on CH16.
7. When a DSC Distress acknowledgment is received, a distress alarm sounds and channel 16 is automatically selected. The LCD shows the MMSI of the ship responding to your distress.

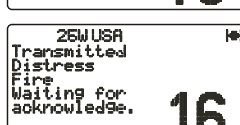
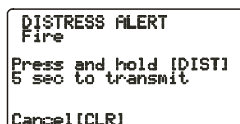

RECEIVED ACK: Acknowledgment signal is received.

RECEIVED RLY ACK: Relay acknowledgment signal is received from another vessel or coast station.

8. To cancel the DSC distress alarm signal from the speaker, press any key.

Cancel a DSC Distress Call

If a DSC Distress call was sent by error, the **FM-4000** allows you to send a message to other vessels to cancel the Distress call.

Press the **[CLR]** key, then press the **[ENT]** key.

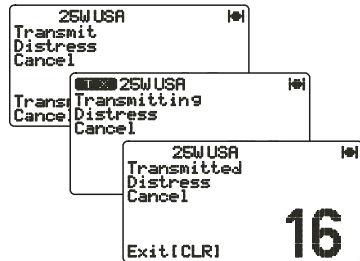

11.3.2 Receiving a DSC Distress Call

1. When a DSC Distress call is received, an emergency alarm sounds.
Then CH16 is automatically selected.
2. Press any key to stop the alarm.
3. The LCD shows the position of the vessel in distress.
4. If the distress data does not include latitude/longitude position, the display shown right appears.

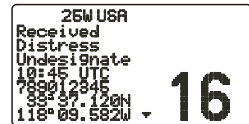

NOTE

You must continue monitoring CH16 as a coast station may require assistance in the rescue attempt.

11.4 ALL SHIPS CALL

The All Ships call function allows contact to be established with other vessel stations without having their ID in the individual calling directory. Also, priority for the call can be designated as Urgency or Safety.

URGENCY Call: This type of call is used when a vessel may not truly be in distress, but have a potential problem that may lead to a distress situation. This call is the same as saying "PAN PAN PAN" on CH16.

SAFETY Call: Transmit boating safety information to other vessels. This message usually contains information about an overdue boat, debris in the water, loss of a navigation aid or an important meteorological message. This call is the same as saying "Securite, Securite, Securite."

11.4.1 Transmitting an All Ships Call

1. Press the [CALL(MENU)] key to show the “DSC Call Menu.”
2. Turn the CHANNEL selector knob to select “All Ships.”
3. Press the [ENT] key. (To cancel, turn the CHANNEL selector knob to select “Exit.”)
4. Turn the CHANNEL selector knob to select the nature of call (“Urgency” or “Safety”), then press the [ENT] key.
5. Press the [ENT] key again to transmit the selected type of All Ships call.
6. After the All Ships call is transmitted, the transceiver switches to CH16.
7. Listen to the channel to make sure it is not busy, then key the microphone and say “PAN PAN PAN” or “Securite, Securite, Securite” depending on the priority of the call. Then announce both your call sign and the channel you wish to switch to for communications.

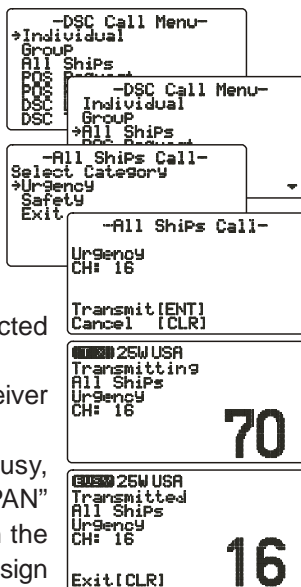

11.4.2 Receiving an All Ships Call

1. When an All Ships call is received, an emergency alarm sounds. The radio will automatically change to CH16 and the LCD shows the MMSI of the vessel transmitting the All Ships call.
2. Press any key to stop the alarm.
3. Monitor CH16 or traffic channel until the Urgency voice communication is completed.



11.5 INDIVIDUAL CALL

This feature allows the **FM-4000** to contact another vessel with a DSC VHF radio and automatically switch the receiving radio to a desired communications channel. This feature is similar to calling a vessel on CH16 and requesting to go to another channel (switching to the channel is private between the two stations).

11.5.1 Setting up the Individual / Position Call Directory

The **FM-4000** has a DSC directory that allows you to store a vessel or person's name and the MMSI number associated with vessels you wish to transmit Individual calls, position requests and position send transmissions.

To transmit an Individual call you must program this directory with information of the persons you wish to call, similar to the telephone directory of a cellular phone.

1. Press and hold down the **[CALL(MENU)]** key until the **"Radio Setup"** menu appears.
2. Turn the **CHANNEL** selector knob to select the **"DSC Setup"** menu.
3. Press the **[ENT]** key, then use the **CHANNEL** selector knob to select **"Individual Directory."**
4. Press the **[ENT]** key.
5. Select **"Add"** with the **CHANNEL** selector knob, then press the **[ENT]** key.
6. Press applicable key to enter the first letter of the name of the vessel or person you want to reference in the directory.
Example: Press the **[2(MEM)]** key repeatedly to toggle among the seven available characters associated with that key: **2 → A → B → C → a → b → c → 2 ...**
 If you enter a wrong character, press the **[CLR]** key to delete the wrong character.
7. Press the **[ENT]** key to store the first letter in the name and move to the next letter to the right.
8. Repeat steps 6 and 7 to complete the name. The name can consist of up to 11 characters. If you do not use all 11 characters press the **[ENT]** key to move to the next space. This method can also be used to enter a blank space in the name. If you enter a wrong character, press the **[H/L]** key until the wrong character is selected, then enter the correct character.
9. After the 11th letter or space has been entered, press and hold the **[ENT]** key to advance to the MMSI (Maritime Mobile Service Identity Number) number entry.
10. Enter the desired number. If you enter a wrong number, press the **[H/L]** key until the wrong number is selected, then enter the correct number.
11. To store the data entered, press and hold the **[ENT]** key.
12. To enter another individual address, repeat steps 5 through 11.
13. Press the **[CLR]** key twice to return to the **"Radio Setup"** menu, then press the **[CLR]** key again to return to radio operation.

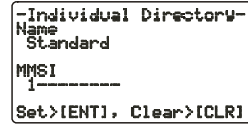
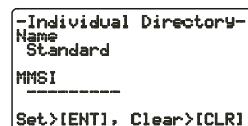
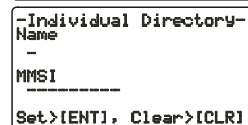
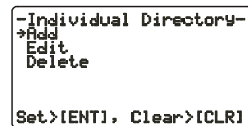
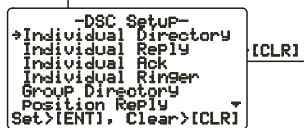
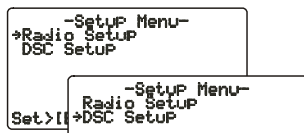

11.5.2 Setting up Individual Reply

Allows setting up the radio to automatically (default setting) or manually respond to a DSC Individual call requesting you to switch to a working channel for voice communications. When Manual is selected, the MMSI of the calling vessel is shown, allowing you to see who is calling. This function is similar to the caller ID on a cellular phone.

1. Press and hold down the **[CALL(MENU)]** key until the “**Radio Setup**” menu appears.
2. Turn the **CHANNEL** selector knob to select “**DSC Setup**” menu.
3. Press the **[ENT]** key, then use the **CHANNEL** selector knob to select “**Individual Reply.**”
4. Press the **[ENT]** key.
5. Turn the **CHANNEL** selector knob to select “**Automatic**” or “**Manual.**”
6. Press the **[ENT]** key to store the selected setting.
7. Press the **[CLR]** key twice to return to the “**Radio Setup**” menu, then press the **[CLR]** key again to return to radio operation.

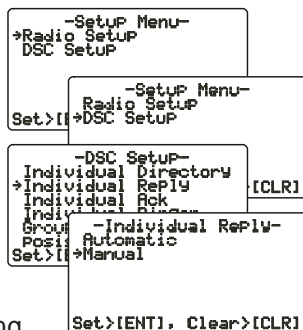

11.5.3 Setting up Individual/Group Call Ringer

When an Individual call or Group call is received the radio will produce a ringing tone for two minutes. This selection allows the Individual call ringer time to be changed.

1. Press and hold down the **[CALL(MENU)]** key until “**Radio Setup**” menu appears.
2. Turn the **CHANNEL** selector knob to select “**DSC Setup**” menu.
3. Press the **[ENT]** key, then use the **CHANNEL** selector knob to select “**Individual Ringer.**”
4. Press the **[ENT]** key.
5. Turn the **CHANNEL** selector knob to select ringing time for an Individual call.
6. Press the **[ENT]** key to store the selected setting.
7. Press the **[CLR]** key twice to return to the “**Radio Setup**” menu, then press the **[CLR]** key again to return to radio operation.

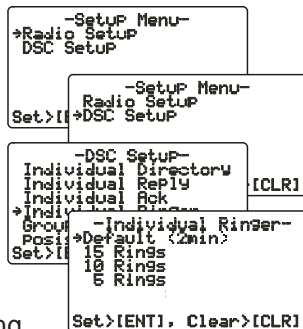

The Individual call and Group call ringers can be disabled as follows:

1. Press and hold down the **[CALL(MENU)]** key until “Radio Setup” menu appears.
2. Turn the **CHANNEL** selector knob to select the “DSC Setup” menu.
3. Press the **[ENT]** key, then use the **CHANNEL** selector knob to select “DSC Beep.”
4. Press the **[ENT]** key.
5. Turn the **CHANNEL** selector knob to select “Individual” if you wish to disable the Individual call ringer, or “Group” if you wish to disable the Group call ringer and press the **[ENT]** key.
6. Turn the **CHANNEL** selector knob to select “Off.”
7. Press the **[ENT]** key to store the selected setting.
8. Press the **[CLR]** key twice to return to the “Radio Setup” menu, then press the **[CLR]** key again to return to radio operation.

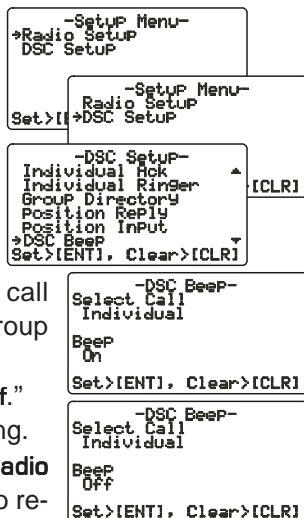

To enable the Individual or Group ringer tone, select “On” in step “6” in this procedure.

11.5.4 Transmitting an Individual Call

The Individual call feature allows you to contact another vessel that has a DSC radio. This feature is similar to calling a vessel on CH16 and requesting to go to another channel.

Using Pre-Programmed Vessel

1. Press the **[CALL(MENU)]** key to show the “DSC Call Menu”.
2. Turn the **CHANNEL** selector knob to select “Individual.” (To cancel, press the **[CLR]** key.)
3. Press the **[ENT]** key. The transceiver beeps then the “Individual directory” appears.
4. Turn the **CHANNEL** selector knob to select the “Individual” you want to contact.
5. Press the **[ENT]** key, then turn the **CHANNEL** selector knob to select the operating channel you want to communicate on, then press the **[ENT]** key.
6. Press the **[ENT]** key again to transmit the individual DSC signal.

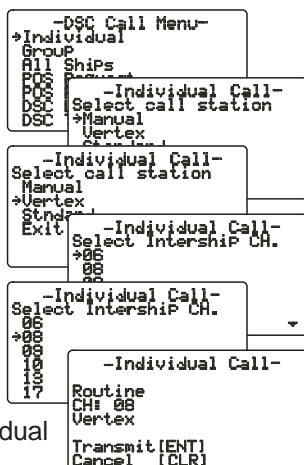

- When an Individual call acknowledgment is received, the channel selected at step 5 is automatically selected and a ringing tone sounds.
- Press [CLR] key to listen to the channel to make sure it is not busy, then key the microphone to call the other vessel.

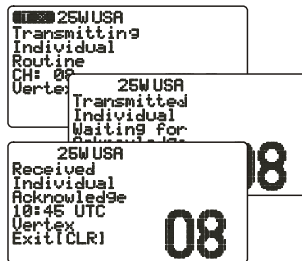

Manual Calling

You may enter an MMSI number manually to contact a vessel which is not stored in the Individual Directory.

- Press the [CALL(MENU)] key to show the “DSC Call Menu.”
- Turn the **CHANNEL** selector knob to select “Individual.” (To cancel, press the [CLR] key.)
- Press the [ENT] key. The transceiver beeps then the “Individual directory” appears.
- Turn the **CHANNEL** selector knob to select “Manual,” then press the [ENT] key.
- Enter the MMSI number (nine digits) which you want to contact, then press the [ENT] key.
- If you enter the wrong number in the MMSI number, press the [H/L] key until the wrong number is selected, then enter the correct number.
- When you are finished entering the MMSI number, press and hold the [ENT] key.
- Turn the **CHANNEL** selector knob to select “Manual,” then press the [ENT] key.
- Turn the **CHANNEL** selector knob to select the operating channel you want to communicate on, then press the [ENT] key.
- Press the [ENT] key again to transmit the individual DSC signal.
- When an Individual call acknowledgment is received, the channel selected at step 5 is automatically selected and a ringing tone sounds.
- Press the [CLR] key to listen to the channel to make sure it is not busy, then key the microphone to call the other vessel.

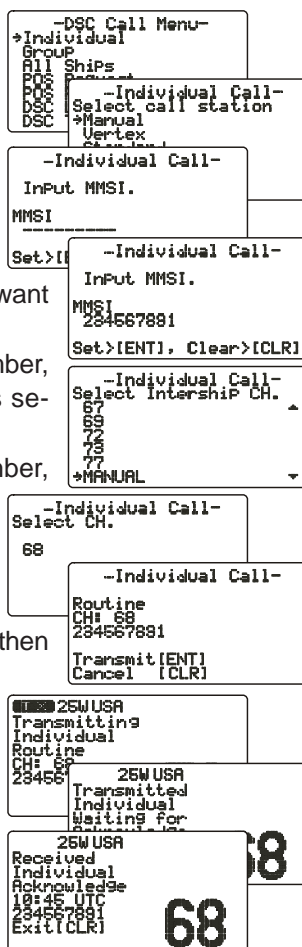

11.5.5 Receiving an Individual Call

When receiving an Individual call, an acknowledgment must be sent back to the calling station, automatically or manual. The default setting is Automatic, but the radio has a selection that allows you to manually send a reply before the radio will switch to the requested calling channel. The default reply method is Automatic, but manual reply (before the radio switches to the requested calling channel) also is available. This selection is useful if you want to see who is calling and requesting you to switch to a channel for communications, similar to the caller ID on a cellular phone.

1. When an Individual call is received, the Individual call ringing alarm sounds. The radio automatically (automatic mode selected) switches to the requested channel and the LCD shows the MMSI of the vessel calling.
2. Press any key to stop the alarm.
3. Press the **PTT** on the microphone and talk to the calling ship.

```
25W USA
Received
Individual
10:45 UTC
Routine
CH 08
789012345
Exit [CLR] 08
```

11.6 CALL WAITING DIRECTORY

The **FM-4000** logs received Distress calls and Individual calls. The DSC Call Waiting feature is similar to an answering machine where calls are recorded for review. When a call is logged while the radio is set on the DSC Standby function, a “” icon appears on the LCD. The **FM-4000** can memorize up to 30 Distress calls, and up to 80 Individual calls.

```
25W USA MEM
33° 37.125N
118° 09.587W
Loc 12:45PM SAFETYV 06
```

11.6.1 Enabling the Call Waiting Feature

Follow the steps below to enable or disable the Call Waiting feature.

1. Press and hold down the [**CALL(MENU)**] key until “Radio Setup” menu appears.
2. Turn the **CHANNEL** selector knob to select “DSC Setup” menu.
3. Press the [**ENT**] key, then use the **CHANNEL** selector knob to select “Individual Ack.”
4. Press the [**ENT**] key.
5. Turn the **CHANNEL** selector knob to select “Able to comply” or “Unable.”
6. Press the [**ENT**] key to store the selected setting.
7. Press the [**CLR**] key twice to return to the “Radio Setup” menu, then press the [**CLR**] key again to return to radio operation.

```
-Setup Menu-
*Radio Setup
DSC Setup

-Setup Menu-
Set>[[ *Radio Setup
DSC Setup

-DSC Setup-
Individual Directory
Individual Reply [CLR]
*Individual Ack
Individual Ack-Unable
Group
Pos:1
-Individual Ack-
Set>[[ *Able to comply
Unable

Set>[ENT], Clear>[CLR]
```

11.6.2 Reviewing Received Calls Logged into the Call Waiting Directory

1. Press the [CALL(MENU)] key to show the “DSC Call Menu.”
2. Turn the CHANNEL selector knob to select the “DSC Log” menu.
3. Press the [ENT] key, then turn the CHANNEL selector knob to select the category (“Distress Alert LOG” or “DSC Call Log”) you want to review and/or call back.
4. Press the [ENT] key, then turn the CHANNEL selector knob to select the station (name or MMSI number) you want to review and/or call back.
5. Press the [ENT] key to review details for the selected station.
6. Press the [ENT] key again to call the selected station.

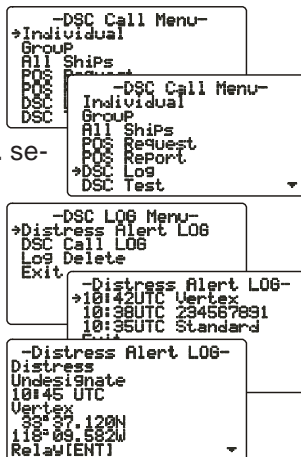

NOTE

When there is an unread received call, the category (“Distress Alert LOG” or “DSC Call Log”) indication will blink.

11.6.3 To Delete the Received Log from the “DSC Log” Directory

1. Press the [CALL(MENU)] key to show the “DSC Call Menu.”
2. Turn the CHANNEL selector knob to select the “DSC Log” menu.
3. Press the [ENT] key, then turn the CHANNEL selector knob to select “Log Delete.”
4. Press the [ENT] key, then turn the CHANNEL selector knob to select the category (“Distress Alert LOG” or “DSC Call LOG”) to delete.
5. Press the [ENT] key, then turn the CHANNEL selector knob to select the station (name or MMSI number) to delete.
6. Press and hold the [ENT] key until the station (name or MMSI number) is removed from the display.
7. To exit this menu and return to radio operation mode, press the [16/9] key.

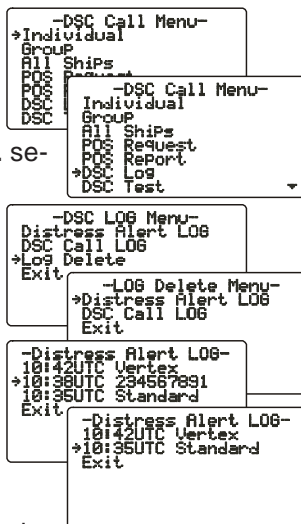

11.7 GROUP CALL

This feature allows the user to contact a group of specific vessels (example members of a yacht club) that have DSC radios with Group call function to automatically switch to a desired channel for voice communications.

11.7.1 Setting up a Group Call

For this function to operate, the same Group MMSI must be programmed into all the DSC VHF radios within the group of vessels that use this feature. To understand about Group MMSI programming, first a Ship MMSI has to be understood.

Ship MMSI: The first three digits called a MID (Mobile Identity Group) of a Ship MMSI denote the country the ship registered for a MMSI. The last six digits are specific to the Ships ID.

Ship MMSI Example: If your MMSI is “366123456”, for example, “366” is the MID, which denotes the country, and “123456” is the ID of your ship.

Group MMSI:

- Group MMSI numbers are not assigned by the FCC or other organizations licensed to assign Ship MMSI numbers.
 - The first digit of a Group MMSI is always set to “0” in accordance with international regulations. All FURUNO radios are preset so when programming a Group MMSI the first digit is set to “0”.
 - The USCG recommends programming the MID of a Ship MMSI into the second, third and fourth digits of the Group MMSI as it denotes the area the ship is located.
 - The last five digits are decided upon by persons in the Group. This is an important step as all radios in the group must contain the same Group MMSI so they can be contacted by each other. There is a chance that another group of vessels have the same Group MMSI as yours. If this happens, simply change one or more of the last five digits of the Group MMSI.
1. Press and hold down the [CALL(MENU)] key until the “Radio Setup” menu appears.
 2. Turn the CHANNEL selector knob to select the “DSC Setup” menu.
 3. Press the [ENT] key, then use the CHANNEL selector knob to select “Group Directory.”
 4. Press the [ENT] key, then select “Add” with the CHANNEL selector knob.
 5. Press the [ENT] key.

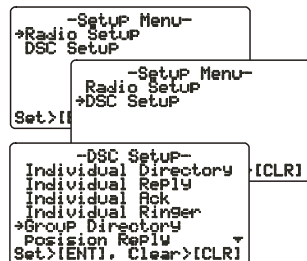

- Press applicable key to enter the first letter of the name of the group you want to reference in the directory.

Example: Press the [2(MEM)] key repeatedly to toggle among the seven available characters associated with that key: 2 → A → B → C → a → b → c → 2 ... If you enter a wrong character, press the [CLR] key to delete the wrong character.

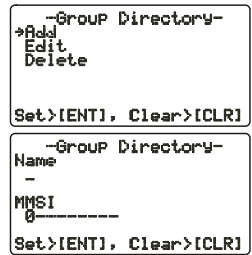

- Press the [ENT] key to store the first letter in the name.
- Repeat steps 6 and 7 to complete the name. The name can consist of up to 11 characters. If you do not use all 11 characters, press the [ENT] key to move to the next space. This method can also be used to enter a blank space in the name. If you enter a wrong character, press the [H/L] key until the wrong character is selected, then enter the correct character.

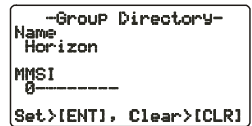

- After the 11th letter or space has been entered, press and hold the [ENT] key to advance to the Group MMSI (Maritime Mobile Service Identity Number) number entry.
- Enter the desired number. If you enter a wrong number, press the [H/L] key until the wrong number is selected, then enter the correct number.
- To store the data entered, press and hold the [ENT] key.
- To enter another group address, repeat steps 4 through 11.
- Press the [CLR] key twice to return to the "Radio Setup" menu, then press the [CLR] key again to return to radio operation.

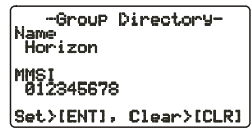
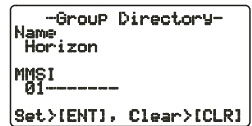

11.7.2 Transmitting a Group Call

Using Pre-Programmed Vessel

- Press the [CALL(MENU)] key to show the "DSC Call Menu."
- Turn the CHANNEL selector knob to select "Group." (To cancel, press the [CLR] key.)
- Press the [ENT] key. The transceiver beeps, and the "Group directory" appears.
- Turn the CHANNEL selector knob to select the "Group" you want to contact.
- Press the [ENT] key, then turn the CHANNEL selector knob to select the operating channel you

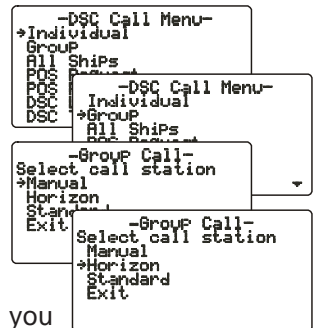

want to communicate on, then press the [ENT] key.

6. Press the [ENT] key again to transmit the Group call signal.
7. When the Group call signal is sent, the LCD displays the information shown in the illustration at right.
8. After the Group call is transmitted, all the radios in the group switch to the designated channel.
9. Listen to the channel to make sure it is not busy, then key the microphone and call the other vessels you desire to communicate with.

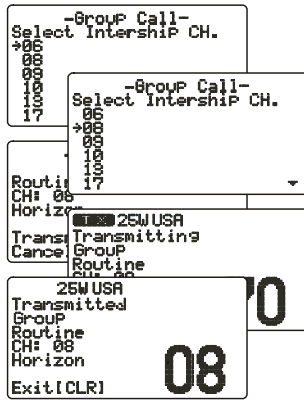

Manual Calling

You may enter a Group MMSI number manually to contact a group whose Group call number is not registered in the radio.

1. Press the [CALL(MENU)] key to show the “DSC Call Menu.”
2. Turn the CHANNEL selector knob to select “Group.” (To cancel, press the [CLR] key.)
3. Press the [ENT] key. The transceiver beeps then the “Group Directory” appears.
4. Turn the CHANNEL selector knob to select “Manual,” then press the [ENT] key.
5. Enter the MMSI number (nine digits: first digit permanently set to “0”) which you want to contact, then press the [ENT] key.
6. If you enter a wrong number in the MMSI number, press the [H/L] key until the wrong number is selected, then enter the correct number.
7. When you have finished entering the MMSI number, press and hold the [ENT] key.
8. Turn the CHANNEL selector knob to select “Manual,” then press the [ENT] key.
9. Turn the CHANNEL selector knob to select the operating channel you want to communicate on, then press the [ENT] key.
10. Press the [ENT] key again to transmit the Group call signal.

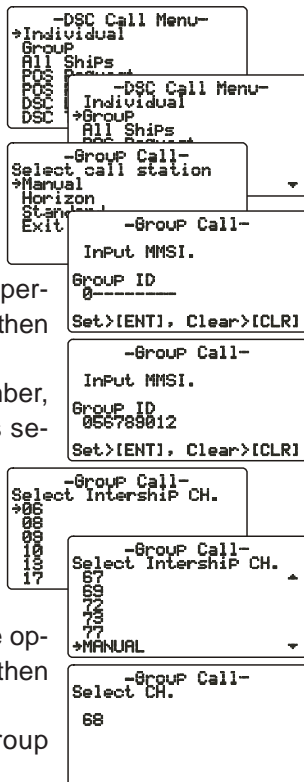

11. After the Group call is transmitted, all the radios in the group switch to the designated channel.
12. Listen to the channel to make sure it is not busy, then key the microphone and call the other vessels.

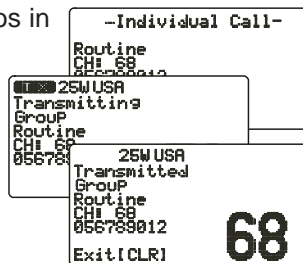

11.7.3 Receiving a Group Call

1. When a Group call is received, the **FM-4000** sounds a ringing alarm and the radio automatically switches to the requested channel.
2. Press any key to stop the alarm.
3. Monitor the channel for a message sent by a person calling the Group.
4. If you want to respond, monitor the channel to make sure it is clear, then press the **PTT** on the microphone and talk to the calling ship(s).



NOTE

After a Group call is received, the time the call was made and the ship's MMSI or vessel's name appear on the LCD.

11.8 POSITION REQUEST

Advancements in DSC have made it possible to poll the location of another vessel and show the position of that vessel on the display of the **FM-4000**. FURUNO has taken this feature one step further. If any FURUNO GPS chart plotters are connected to the **FM-4000**, the polled position of the vessel is shown on the display of the GPS chart plotter, making it easy to navigate to the location of the polled vessel. This is a great feature for anyone wanting to know the position of another vessel. For example, your buddy that is catching fish, or finding the location of a person you are cruising with.

NOTE

The other vessel must have an operating GPS receiver connected to its DSC transceiver and must not have its transceiver set to deny position requests. (See the section “**11.5 INDIVIDUAL CALL**” to enter information into the individual directory).

11.8.1 Setting up Position Reply

The **FM-4000** can automatically or manually send your position to another vessel. This selection is important if you are concerned about someone polling the position of your vessel that you may not want to. In the manual mode you will see the MMSI or person’s name shown on the display, allowing you to choose to send your position to the requesting vessel or not.

1. Press and hold down the **[CALL(MENU)]** key until the “**Radio Setup**” menu appears.
2. Turn the **CHANNEL** selector knob to select the “**DSC Setup**” menu.
3. Press the **[ENT]** key, then use the **CHANNEL** selector knob to select “**Position Reply**.”
4. Turn the **CHANNEL** selector knob to select “**Automatic**” or “**Manual**.” In the “**Automatic**” mode, after a DSC POS Request is received, the radio will automatically transmit your vessel’s position. In the “**Manual**” mode, the display of the **FM-4000** will show who is requesting your position.
5. Press the **[ENT]** key to store the selected setting.
6. Press the **[CLR]** key twice to return to the “**Radio Setup**” menu, then press the **[CLR]** key again to return to radio operation.

```
-Setup Menu-
*Radio Setup
DSC Setup

Set>[ENT], Clear>[CLR]
```

```
-Setup Menu-
Radio Setup
*DSC Setup

Set>[ENT], Clear>[CLR]
```

```
-DSC Setup-
Individual Directory
Individual Reply
Individual Ack
Individual Rinser
Group Directory
*Position Reply
Set>[ENT], Clear>[CLR]
```

```
-Position Reply-
*Automatic
Manual

Set>[ENT], Clear>[CLR]
```

11.8.2 Transmitting a Position Request to Another Vessel

Using Pre-Programmed Vessel

1. Press the [CALL(MENU)] key to show the “DSC Call Menu.”
2. Turn the CHANNEL selector knob to select “Pos Request.”
3. Press [ENT] key to show the Position Request Directory. This directory uses the Individual Directory information.
4. Turn the CHANNEL selector knob to select a name, then press the [ENT] key.
5. Press the [ENT] key again to transmit the Position Request DSC call.
6. When the FM-4000 receives the position from the polled vessel it is shown on the radio display and also transferred to the GPS chart plotter.

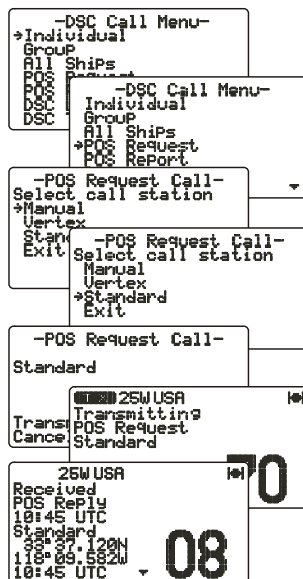

NOTE

If the FM-4000 does not receive position data from the polled vessel, the LCD shows “NO POSITION DATA.”

Manual Request

You may enter an MMSI number manually to request the position of a vessel that is not registered in the Setting up the Individual / Position Call Directory.

1. Press the [CALL(MENU)] key to show the “DSC Call Menu.”
2. Turn the CHANNEL selector knob to select “Pos Request.”
3. Press the [ENT] key to show the Position Request directory. This directory uses the Individual Directory information.
4. Turn the CHANNEL selector knob to select “Manual,” then press the [ENT] key.
5. Enter the MMSI number (nine digits) which you want to contact by the keypad, then press the [ENT] key.
6. If you enter a wrong number in the MMSI number, press the [H/L] key until the wrong num-

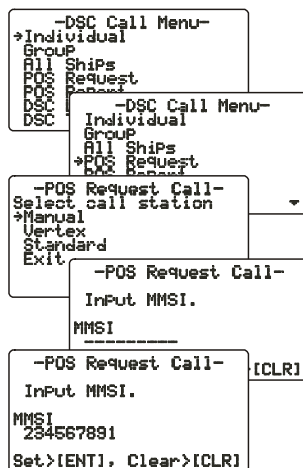

- ber is selected, then enter the correct number.
- When you have finished entering the MMSI number, press and hold the [ENT] key.
 - Press the [ENT] key to transmit the Position Request DSC call.
 - When the **FM-4000** receives the position from the polled vessel it is shown on the radio display and also transferred to the GPS chart plotter.

```

-POS Request Call-
234567891

Transmit [ENT]
Cancel  [CLR]

```

```

25W USA
Transmitting
POS Request
234567891

```

```

25W USA
Received
POS Request
10:45 UTC
234567891
09:27.120N
118:09.582W
10:45 UTC
08

```

11.8.3 Receiving a Position Request

When a Position Request call is received from another vessel, a ringing alarm will sound and “POS REQUEST” appears. Operation and transceiver function differ depending on the “Position Reply” setting in the “DSC Setup” menu.

Automatically reply:

- When a Position Request call is received, a calling alarm sounds four times. Then requested position coordinates are transmitted automatically to the vessel requesting your vessel's position.
- To exit from the Position Request display, press the [CLR] key.

```

25W USA
Received
POS Reply
10:45 UTC
Standard
Exit [CLR]
08

```

Manually reply:

- When a Position Request call is received from another vessel, the LCD shows the time and MMSI or name of person requesting your vessel's position.
- A ringing alarm sounds four times. To send your vessel's position to the requesting vessel, press the [ENT] key. Or to exit from Position Request display, press the [CLR] key.

```

25W USA
Received
POS Request
10:45 UTC
Standard
Reply [ENT]
Exit [CLR]
08

```

11.9 POSITION SEND

The feature is similar to Position Request, however instead of requesting a position of another vessel this function allows you to send your position to another vessel. Your vessel must have an operating GPS receiver connected to the **FM-4000** to send your position.

NOTE

To transmit a Position Send call, you must set up the **FM-4000** DSC Individual / Position Call Directory with the name of the vessel(s) or person and the MMSI of the DSC radio you wish to send your position to. To setup this directory, see section “11.5.1 Setting up the Individual / Position Call Directory.”

11.9.1 Setting up a Position Send Ringer

The **FM-4000** has the capability to turn off the Position Send ringer as follows.

1. Press and hold down the [CALL(MENU)] key until the “Radio Setup” menu appears.
2. Turn the **CHANNEL** selector knob to select the “DSC Setup” menu.
3. Press the [ENT] key, then use the **CHANNEL** selector knob to select “DSC Beep.”
4. Press the [ENT] key, then use the **CHANNEL** selector knob to select “Position Report.”
5. Press the [ENT] key, then select “Off” with the **CHANNEL** selector knob.
6. Press the [ENT] key to store the selected setting.
7. Press the [CLR] key twice to return to the “Radio Setup” menu, then press the [CLR] key again to return to radio operation.

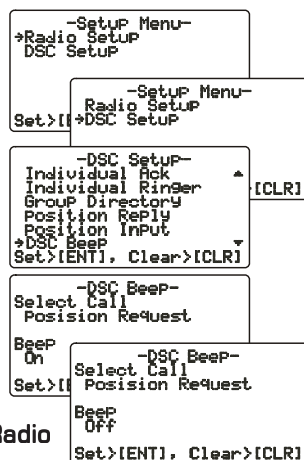

To enable the ringer tone, select “On” at step “6” in this procedure.

11.9.2 Transmitting a DSC Position Send Call

Using Pre-Programmed Vessel

1. Press the [CALL(MENU)] key to show the “DSC Call Menu.”
2. Turn the **CHANNEL** selector knob to select “Pos Report.”

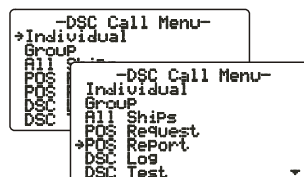

3. Press [ENT] key to show the Position Send Directory. This directory uses the Individual Directory information.
4. Turn the **CHANNEL** selector knob to select a name in the directory, then press the [ENT] key.
5. Press the [ENT] key again to send your position to the selected vessel.
6. Press the [CLR] key twice to return to the “Radio Setup” menu, then press the [CLR] key again to return to radio operation.

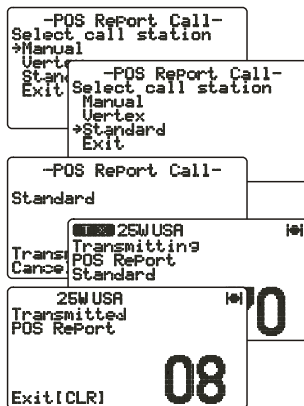

Manual Calling

You may enter an MMSI number manually to send your position to that vessel without entering it into the Setting up the Individual / Position Call Directory.

1. Press the [CALL(MENU)] key to show the “DSC Call Menu.”
2. Turn the **CHANNEL** selector knob to select “Pos Report.”
3. Press [ENT] key to show the Position Send Directory. This directory uses the Individual Directory information.
4. Turn the **CHANNEL** selector knob to select “Manual,” then press the [ENT] key.
5. Enter the MMSI number (nine digits: first digit permanently set to “0”) which you want to contact, then press the [ENT] key.
6. If you enter a wrong number in the MMSI number, press the [H/L] key until the wrong number is selected, then enter the correct number.
7. When you have finished entering the MMSI number, press and hold the [ENT] key.
8. Press the [ENT] key to send your position to the selected vessel.

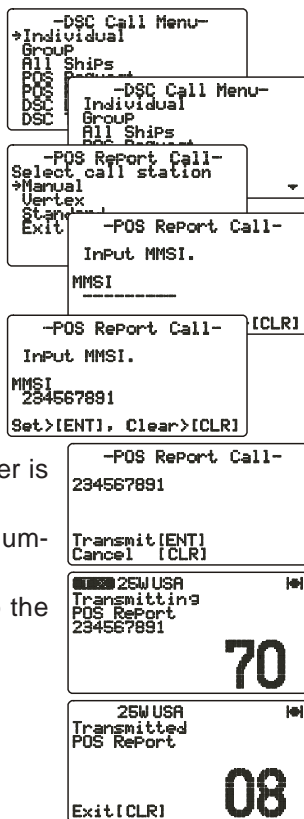

11.9.3 Receiving a DSC Position Send Call

When another vessel transmits its location to the **FM-4000**, the following occurs:

1. A ringing sound is generated when the call is received.
2. Press any key to stop the ringing sound.
3. The position of the vessel is shown and also transferred to any FURUNO GPS chart plotter if connected.

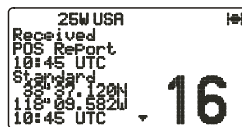

11.10 MANUAL INPUT OF POSITION (LAT/LON)

You may send the latitude/longitude of your vessel manually when the **FM-4000** is not connected to a GPS receiver.

After the position is entered, any DSC Distress, Position Request, or Position Send will contain the manually entered position.

1. Press and hold down the **[CALL(MENU)]** key until the “**Radio Setup**” menu appears.
2. Turn the **CHANNEL** selector knob to select the “**DSC Setup**” menu.
3. Press the **[ENT]** key, then use the **CHANNEL** selector knob to select “**Position Input.**”
4. Press the **[ENT]** key. The transceiver beeps, then the display looks something like the one in the illustration at right.
5. Enter your local UTC time in the 24-hour notation, then press the **[ENT]** key.
6. Enter the latitude/longitude of your vessel, then press the **[ENT]** key. To select North (N) press the **[6(NAV)]** key, South (S) press the **[7(SCRM)]** key, East (E) press the **[3(SCAN)]** key or West (W) press the **[9(FOG)]** key.
7. To store the data entered, press and hold the **[ENT]** key.
8. Press the **[CLR]** key twice to return to the “**Radio Setup**” menu, then press the **[CLR]** key again to return to radio operation.

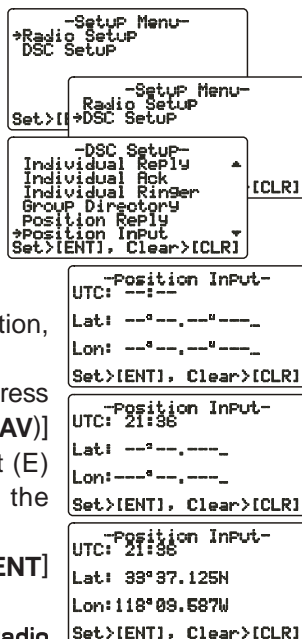

12 RADIO SETUP

NOTE

The optional **CMP30** Remote MIC can also access the SETUP menu.
See page 73 for details.

12.1 LCD CONTRAST

Adjust the LCD contrast for best viewability.

1. Press and hold down the [**CALL(MENU)**] key until “**Radio Setup**” menu appears.
2. Press the [**ENT**] key, then use the **CHANNEL** selector knob to select “**Contrast.**”
3. Press the [**ENT**] key.
4. Turn the **CHANNEL** selector knob to select the desired level. The contrast level can be set from “0” to “31.”
5. Press the [**ENT**] key to store the selected level.
6. To exit this menu and return to radio operation mode, press the [**16/9**] key.

```
-Setup Menu-
+Radio Setup
DSC Setup
Set>[ENT], Clear>[CLR]
```

```
-Radio Setup-
+Contrast
Time Offset
Time Display
SDG Unit
Magnetic
Priority CH
Set>[ENT], Clear>[CLR]
```

```
-Contrast-
20
11-3000
11-000
+000
Set>[ENT], Clear>[CLR]
```

12.2 TIME OFFSET

“Time Offset” sets the time offset between local time and UTC in order to display local time. The time display requires connection of a GPS receiver.

1. Press and hold down the [CALL(MENU)] key until the “Radio Setup” menu appears.
2. Press the [ENT] key, then use the CHANNEL selector knob to select “Time Offset.”
3. Press the [ENT] key.
4. Turn the CHANNEL selector knob to select time offset from UTC. See the illustration below to find your offset time from UTC. If “0:00” is assigned, the time is the same as UTC (Universal Time Coordinated or GMT Greenwich Mean Time).
5. Press the [ENT] key to store the time offset.
6. To exit this menu and return to radio operation mode, press the [16/9] key.

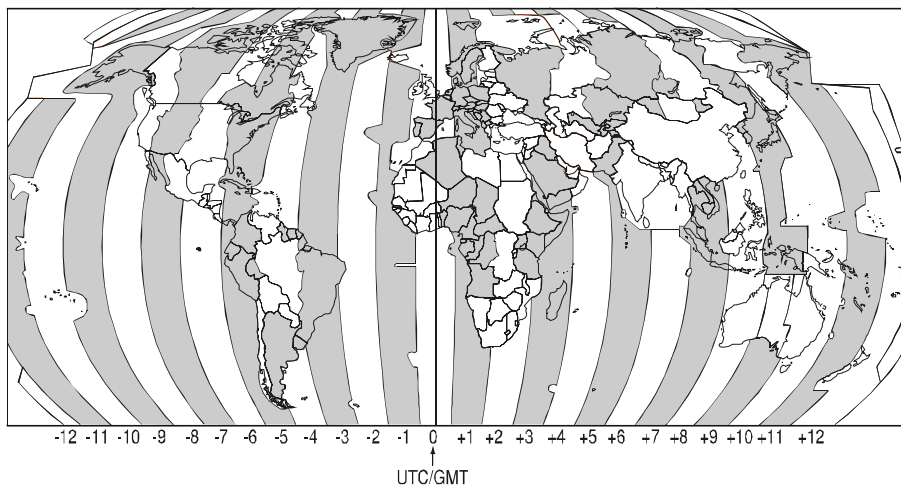
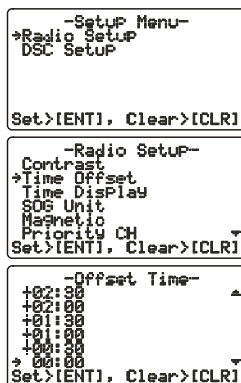

OFFSET TIME TABLE

12.3 TIME DISPLAY

The time can be shown in local or UTC time. The time display requires connection of a GPS receiver.

1. Press and hold down the [CALL(MENU)] key until the “Radio Setup” menu appears.
2. Press the [ENT] key, then use the CHANNEL selector knob to select “Time Display.”
3. Press the [ENT] key.
4. Turn the CHANNEL selector knob to select “UTC” or “Local.”
5. Press the [ENT] key to store the selected setting.
6. To exit this menu and return to radio operation mode, press the [16/9] key.

In the local time mode, the display shows the time by the 12-hour system, while the display shows the time by the 24-hour system in the UTC mode.

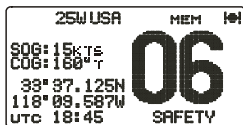

(“UTC” mode)

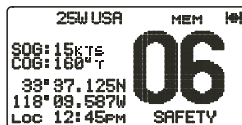

(“LOCAL” mode)

```
-Setup Menu-
+Radio Setup
DSC Setup

Set>[ENT], Clear>[CLR]
```

```
-Radio Setup-
Contrast
Time Offset
+Time Display
SOG Unit
Magnetic
Priority CH
Set>[ENT], Clear>[CLR]
```

```
-Time Display-
+UTC
Local

Set>[ENT], Clear>[CLR]
```

12.4 SOG (SPEED OVER GROUND) UNIT

The SOG indication can be shown in knot, mph or kph.

1. Press and hold down the [CALL(MENU)] key until the “Radio Setup” menu appears.
2. Press the [ENT] key, then use the CHANNEL selector knob to select “SOG Unit.”
3. Press the [ENT] key.
4. Turn the CHANNEL selector knob to select desired unit.
5. Press the [ENT] key to store the selected setting.
6. To exit this menu and return to radio operation mode, press the [16/9] key.

```
-Setup Menu-
+Radio Setup
DSC Setup

Set>[ENT], Clear>[CLR]
```

```
-Radio Setup-
Contrast
Time Offset
Time Display
+SOG Unit
Magnetic
Priority CH
Set>[ENT], Clear>[CLR]
```

```
-SOG Unit-
+Kts :Knots
MPH :Mile/hour
Kmh :Kilo-Meter/hour

Set>[ENT], Clear>[CLR]
```

12.5 TRUE MAGNETIC CHANGE (NAV DISPLAY)

The GPS COG (Course Over Ground) indication can be shown in True or Magnetic.

1. Press and hold down the [CALL(MENU)] key until the "Radio Setup" menu appears.
2. Press the [ENT] key, then use the CHANNEL selector knob to select "Magnetic."
3. Press the [ENT] key.
4. Turn the CHANNEL selector knob to select "Magnetic" or "True."
5. Press the [ENT] key to store the selected setting.
6. To exit this menu and return to radio operation mode, press the [16/9] key.

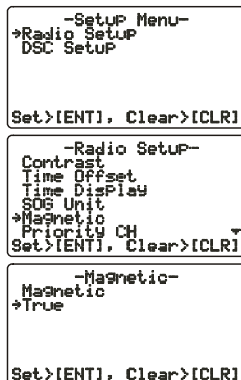

12.6 PRIORITY CHANNEL

You can set the priority channel to use when priority scan is enabled.

1. Press and hold down the [CALL(MENU)] key until the "Radio Setup" menu appears.
2. Press the [ENT] key, then use the CHANNEL selector knob to select "Priority CH."
3. Press the [ENT] key.
4. Turn the CHANNEL selector knob to select the channel to be a priority.
5. Press the [ENT] key to store the selected setting.
6. To exit this menu and return to radio operation mode, press the [16/9] key.

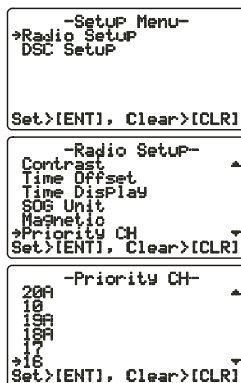

12.7 SCAN TYPE

You can set the scan mode between “Memory Scan” and “Priority Scan.”

1. Press and hold down the [CALL(MENU)] key until the “Radio Setup” menu appears.
2. Press the [ENT] key, then use the CHANNEL selector knob to select “SCAN Type.”
3. Press the [ENT] key.
4. Turn the CHANNEL selector knob to select “Priority SCAN” or “Memory SCAN.”
5. Press the [ENT] key to store the selected setting.
6. To exit this menu and return to radio operation mode, press the [16/9] key.

```
-Setup Menu-
+Radio Setup
DSC Setup

Set>[ENT], Clear>[CLR]
```

```
-Radio Setup-
Time Offset ▲
Time Display
SDG Unit
Magnetic
Priority CH
+SCAN Type ▼
Set>[ENT], Clear>[CLR]
```

```
-SCAN TYPE-
+Priority SCAN
Memory SCAN

Set>[ENT], Clear>[CLR]
```

12.8 SCAN RESUME TIME

Set the amount of time the FM-4000 waits after a transmission ends before starting scanning.

1. Press and hold down the [CALL(MENU)] key until the “Radio Setup” menu appears.
2. Press the [ENT] key, then use the CHANNEL selector knob to select “SCAN Resume.”
3. Press the [ENT] key.
4. Turn the CHANNEL selector knob to select the desired resume time. The resume time can be set to “1sec” through “5sec,” or “Off.” In the “Off” selection, the scanning resumes after the other station stops transmitting (carrier drops).
5. Press the [ENT] key to store the selected setting.
6. To exit this menu and return to radio operation mode, press the [16/9] key.

```
-Setup Menu-
+Radio Setup
DSC Setup

Set>[ENT], Clear>[CLR]
```

```
-Radio Setup-
Time Offset ▲
Time Display
SDG Unit
Magnetic
Priority CH
+SCAN TYPE ▼
+SCAN Resume ▼
Set>[ENT], Clear>[CLR]
```

```
-SCAN Resume-
Off
1sec
+2sec
3sec
4sec
5sec
Set>[ENT], Clear>[CLR]
```

12.9 KEY BEEP

Set the beep tone volume level when a key is pressed.

1. Press and hold down the [CALL(MENU)] key until the "Radio Setup" menu appears.
2. Press the [ENT] key, then use the CHANNEL selector knob to select "Key Beep."
3. Press the [ENT] key.
4. Turn the CHANNEL selector knob to select the desired level. The beep can be set from "Level 1" to "Level 6," "High," or "Off."
5. Press the [ENT] key to set the key beep condition.
6. To exit this menu and return to radio operation mode, press the [16/9] key.

```
-Setup Menu-
->Radio Setup
DSC Setup

Set>[ENT], Clear>[CLR]
```

```
-Radio Setup-
SOG Unit
Magnetic
Priority CH
SCAN Type
SCAN Resume
->Key Beep
Set>[ENT], Clear>[CLR]
```

```
-Key Beep-
Level 6
Level 5
Level 4
Level 3
Level 2
Level 1
->Off
Set>[ENT], Clear>[CLR]
```

NOTE

Emergency alarm and beeps for DSC operation cannot be turned OFF.

12.10 WEATHER ALERT SETUP

The NOAA Weather alert can be enabled or disabled. The default setting is "On SCAN and WX CH."

1. Press and hold down the [CALL(MENU)] key until the "Radio Setup" menu appears.
2. Press the [ENT] key, then use the CHANNEL selector knob to select "Weather Alert."
3. Press the [ENT] key.
4. Turn the CHANNEL selector knob to select the desired WX alert mode. The WX alert mode can be set to "On WX CH," "On SCAN," "On SCAN and WX CH," or "Off."
5. Press the [ENT] key to store the selected setting.
6. To exit this menu and return to radio operation mode, press the [16/9] key.

```
-Setup Menu-
->Radio Setup
DSC Setup

Set>[ENT], Clear>[CLR]
```

```
-Radio Setup-
Magnetic
Priority CH
SCAN Type
SCAN Resume
->Key Beep
Weather Alert
Set>[ENT], Clear>[CLR]
```

```
-Weather Alert-
On WX CH
On SCAN
->On SCAN and WX CH
Off

Set>[ENT], Clear>[CLR]
```

12.11 CHANNEL NAMING

You may change the name of a channel.

Example: CH84 “CALL HOME”

1. Press and hold down the [**CALL(MENU)**] key until the “**Radio Setup**” menu appears.
2. Press the [**ENT**] key, then use the **CHANNEL** selector knob to select “**CH Name**.”
3. Press the [**ENT**] key.
4. Turn the **CHANNEL** selector knob to select the channel to name, then press the [**ENT**] key.
5. Press applicable key to enter the first letter of the channel name.

Example: Press the [**4(GHI)**] key repeatedly to toggle among the seven available characters associated with that key: **4** → **G** → **H** → **I** → **g** → **h** → **i** → **2**

6. Press the [**ENT**] key to enter the desired letter and move the cursor one space to the right.
7. Repeat steps 5 and 6 to complete the name. The name can consist of up to 16 characters. If you do not use all 16 characters, press the [**ENT**] key to move to the next space. This method can also be used to enter a blank space in the name. To clear the previous letter, press the [**CLR**] key.
8. Press and hold down the [**ENT**] key to enter the name.
9. If you want to change the name of another channel, repeat steps 3 through 8.
10. To exit this menu and return to radio operation mode, press the [**16/9**] key.

```
-Setup Menu-
+Radio Setup
DSC Setup

Set>[ENT], Clear>[CLR]
```

```
-Radio Setup-
Priority CH
SCAN Type
SCAN Resume
Key Beep
Weather Alert
+CH Name
Set>[ENT], Clear>[CLR]
```

```
-CH Name-
Select CH
88
CH Name
PLEASURE
Set>[ENT], Clear>[CLR]
```

```
-CH Name-
Select CH
88
CH Name
PLEASURE
Set>[ENT], Clear>[CLR]
```

```
-CH Name-
Select CH
88
CH Name
HOOORPRE
Set>[ENT], Clear>[CLR]
```

```
-CH Name-
Select CH
88
CH Name
HOOORUP
Set>[ENT], Clear>[CLR]
```

12.12 NAMING THE RADIO OR REMOTE MIC

You can change the name of the RADIO or Remote MIC. Example: “RADIO - Cabin,” “RAM1 - Flybridge.”

1. Press and hold down the [CALL(MENU)] key until the “Radio Setup” menu appears.
2. Press the [ENT] key, then use the CHANNEL selector knob to select “Unit Name.”
3. Press the [ENT] key.
4. With the Remote MIC connected, turn the CHANNEL selector knob to select the Unit (“Radio” or “RAM1”) to name, then press the [ENT] key, otherwise press the [ENT] key.
5. Press applicable key to enter the first letter of channel name.
Example: Press the [2(MEM)] key repeatedly to toggle among the seven available characters associated with that key: 2 → A → B → C → a → b → c → 2 ...
6. Press the [ENT] key to enter the first letter in the name and move to the next letter to the right.
7. Repeat steps 5 and 6 to complete the name. The name can consist of up to eight characters. If you do not use all eight characters press the [ENT] key to move to the next space. This method can also be used to enter a blank space in the name. To clear the previous letter, press the [CLR] key.
8. Press and hold the [ENT] key to enter the name and return to the “Unit Name” menu.
9. If you want to enter the name of another unit, repeat steps 4 through 8.
10. To exit this menu and return to radio operation mode, press the [16/9] key.

```

-Setup Menu-
+Radio Setup
DSC Setup

Set>[ENT], Clear>[CLR]
    
```

```

-Radio Setup-
SCAN Type
SCAN Resume
Key Beep
Weather Alert
CH Name
+Unit Name
Set>[ENT], Clear>[CLR]
    
```

```

-Unit Name-
Select Unit
RADIO

Unit Name
RADIO

Set>[ENT], Clear>[CLR]
    
```

```

-Unit Name-
Select Unit
RADIO

Unit Name
CADIO

Set>[ENT], Clear>[CLR]
    
```

```

-Unit Name-
Select Unit
RADIO

Unit Name
Cabin

Set>[ENT], Clear>[CLR]
    
```

12.13 ADJUSTING THE TREBLE AND BASS

Adjust the treble and bass of the speaker audio for best listening in noisy environments. The effect is similar to adjusting the treble and bass controls on a stereo.

1. Press and hold down the [CALL(MENU)] key until “Radio Setup” menu appears.
2. Press the [ENT] key, then use the CHANNEL selector knob to select “Tone Control.”
3. Press the [ENT] key, then select “Bass” with the CHANNEL selector knob.
4. Press the [ENT] key, then turn the CHANNEL selector knob to select desired audio response in the lower frequency range. Available selections are “-6” through “+6.”
5. Press the [ENT] key to store the selected setting.
6. Select “Treble” with the CHANNEL selector knob, then press the [ENT] key.
7. Turn the CHANNEL selector knob to select desired audio response in the higher frequency range. Available selections are “-6” through “+6.”
8. Press the [ENT] key to store the selected setting.
9. To exit this menu and return to radio operation mode, press the [16/9] key.

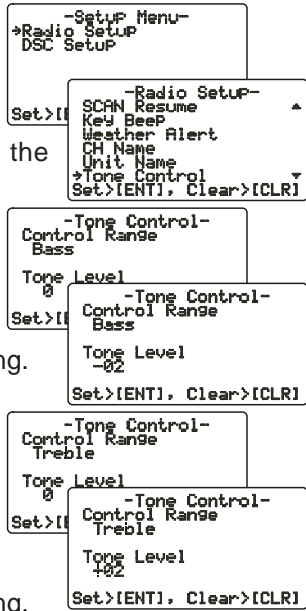

12.14 FOG ALERT TONE FREQUENCY

You can select the tone frequency for the PA/Fog operation. The available frequency range is 200 Hz - 850 Hz, in 50 Hz steps. The default tone frequency is 400 Hz.

1. Press and hold down the [CALL(MENU)] key until the “Radio Setup” menu appears.
2. Press the [ENT] key, then use the CHANNEL selector knob to select “FOG Frequency..”
3. Press the [ENT] key.
4. Turn the CHANNEL selector knob to select desired tone frequency.
5. Press the [ENT] key to store the selected setting.
6. To exit this menu and return to radio operation mode, press the [16/9] key.

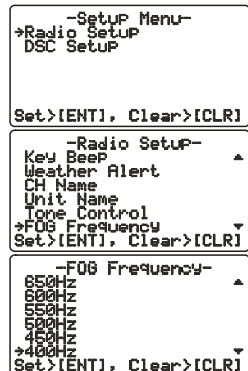

12.15 CALENDAR SETUP

Calendar Menu

The **FM-4000** has a clock that remembers date, time, latitude and longitude. Connecting a GPS receiver to the **FM-4000** is very important as it not only will be used to update the calendar automatically and also when a DSC Distress call is transmitted will send your vessel's location to other vessels to aid in the rescue. See section "8.5 ACCESSORY CABLE."

GPS Receiver Connected

When a GPS receiver is connected, the **FM-4000** will automatically store the calendar date and time information after being connected for one hour.

GPS Receiver Not Connected

If a GPS receiver is not connected to the **FM-4000**, manually enter the date and time into the Calendar Menu in order for the clock to operate. The time you will enter will be your local time in UTC format. To calculate your local UTC time, first find your location on the Standard Time table below.

NOTE

The table below shows Standard Time. For Daylight Savings subtract one hour from your offset.

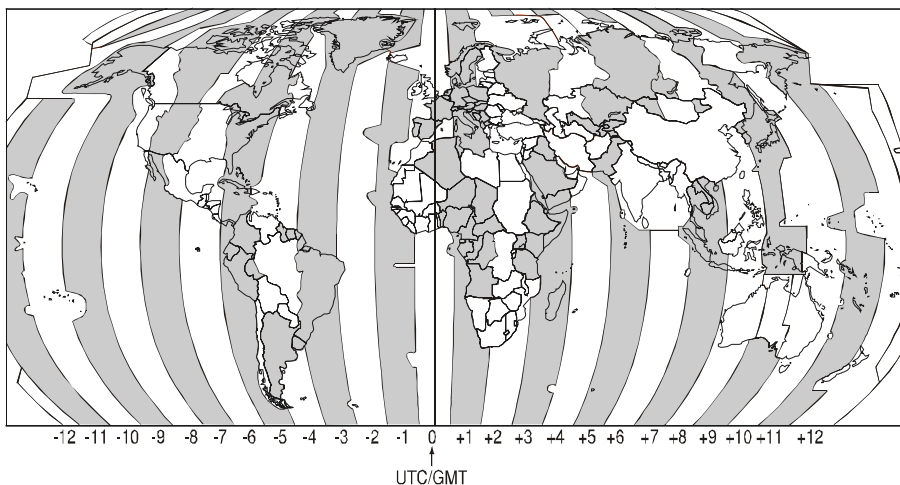

Examples:

NOTE

If you are west of UTC time you will add the offset to your time.
 If you are East of UTC time you will subtract the offset from your time.

City	Los Angeles
Offset	-8
Time (convert local time to 24 hour)	4:00PM (local) or 16:00 (24hour)
Calculate 24hour local + Offset (East of UTC)	16:00 + 08:00 = 22:00
City	NY
Offset	-5
Time (convert local time to 24 hour)	4:00PM (local) or 16:00 (24hour)
Calculate 24hour local + Offset (East of UTC)	16:00 + 05:00 = 21:00
City	Rome
Offset	+1
Time (convert local time to 24 hour)	4:00PM (local) or 16:00 (24hour)
Calculate 24hour local + Offset (East of UTC)	16:00 - 01:00 = 15:00

1. Press and hold the [CALL(MENU)] key until the “Radio Setup” menu appears.
2. Press the [ENT] key
3. Select “Calendar” with the CHANNEL selector knob.
4. Press the [ENT] key
5. Select “Date (20YY/MM/DD)” with the CHANNEL selector knob.
6. Press the [ENT] key.
7. Enter the current date (Yr/Mo/Day).
8. If you enter a wrong number, press the [H/L] key until the wrong number is selected, then enter the correct number.
9. Using the Standard time table above, calculate the UTC time of your position.
Note: For daylight savings time subtract one hour to the offset in your time zone.
10. To enter the time, press the [ENT] key until the first digit in the “Time (hh/mm [UTC])” is selected on the display, then enter the time.
11. Press and hold down the [ENT] key to store the selected setting.
12. Select “Update” with the CHANNEL selector knob, then press the [ENT] key.

```

-Setup Menu-
+Radio Setup
DSC Setup

Set>[ENT], Clear>[CLR]
    
```

```

-Calendar-
+Calendar
Update

Set>[ENT], Clear>[CLR]
    
```

```

-Date-
Date<20YY/MM/DD>
20--/--/--

Time<hh/mm[UTC]>
--:--

Set>[ENT], Clear>[CLR]
    
```

```

-Date-
Date<20YY/MM/DD>
2007/04/01

Time<hh/mm[UTC]>
--:--

Set>[ENT], Clear>[CLR]
    
```

```

-Date-
Date<20YY/MM/DD>
2007/04/01

Time<hh/mm[UTC]>
18:00

Set>[ENT], Clear>[CLR]
    
```

```

-Calendar-
+Calendar
+Update

Set>[ENT], Clear>[CLR]
    
```

13. Turn the **CHANNEL** selector knob to select the method of the time adjustment between “**Automatic**” and “**Manual**.”

14. Press the [ENT] key to store the selected setting.

15. To exit this menu and return to radio operation mode, press the [16/9] key.

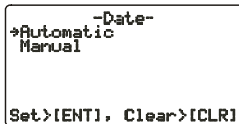

13 REMOTE MIC OPERATION

When the Remote MIC is connected to the **FM-4000**, most VHF, DSC, setup menus and PA modes can be remotely operated. The Remote MIC is supplied with 23 feet (7 m) of routing cable and can be extended up to 70 feet (21 m) using three 23-foot extension cables model **CT-100**. The Intercom feature can be used between the Remote MIC and the transceiver. In addition, speaker wires are supplied at the panel mount of the routing cable for external speakers to be connected in noisy environments.

13.1 REMOTE MIC CONTROLS

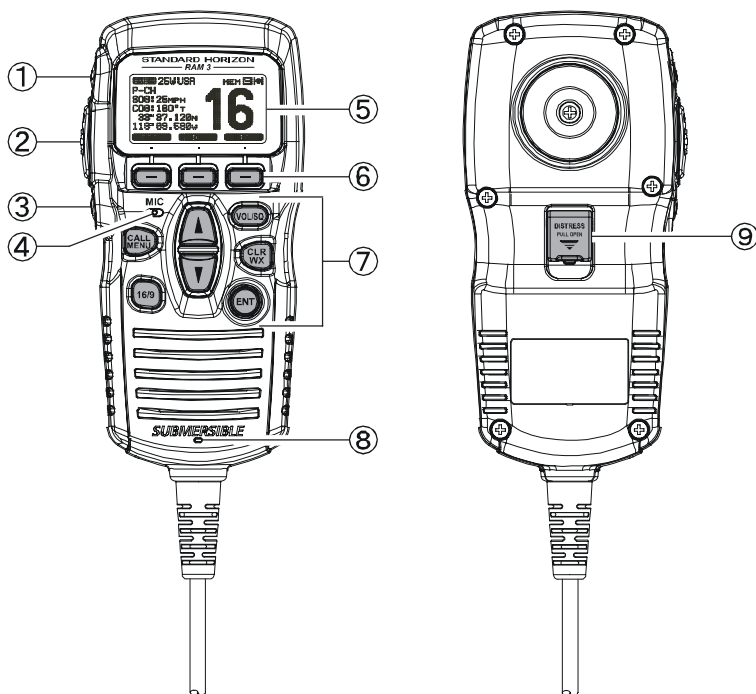

① [H/L] KEY

Toggles between high and low power. When the [H/L] key is pressed while the transceiver is on CH13 or CH67, the power is temporarily switched from LO to HI until the **PTT** switch is released. The [H/L] key does not function on transmit inhibited and low-power only channels.

② PTT (Push-To-Talk) Key

Activates transmission.

③ **POWER (⏻) Key**

Press and hold down this key to turn to the transceiver and Remote MIC on or off.

④ **MICROPHONE**

The internal microphone is located here.

When transmitting, position your mouth about 1/2 to 1 inch (1.2 ~ 2.5 cm) away from the small mic hole. Speak slowly and clearly into the microphone.

⑤ **DISPLAY**

Channel display.

⑥ **SOFT KEY**

These three key's functions can be customized by the Setup Menu mode. When press one of these key briefly, the key functions will appear at the LCD bottom. The factory defaults are shown below.

[SCAN] Key

Starts and stops scanning of programmed channels.

[DW] Key

Watches for a transmission on CH16 and another selected channel until either signal is received. (Dual watch)

[IC] Key

Get Intercom operation between radio and the Remote MIC.

⑦ **KEY PAD**

[CALL/MENU] Key

Press this key to access the DSC OPERATION menu.

Press and hold this key to access the SETUP menu.

[16/9] Key

First press: channel 16 is immediately selected.

Second press: recalls the last selected channel.

Press and hold: selects channel 9.

[▲](UP)/[▼](DOWN) Key

These keys are used to select channels, adjust the volume and squelch level, and to choose DSC calls, DSC setup and Radio setup function.

[VOL/SQ] Key (Volume Control / Squelch Control)

Press this key to toggle the function of the Remote MIC's [▲] or [▼] key between the channel selections, volume level adjustment, and squelch level adjustment.

[CLR/WX] Key

Immediately recalls the previously selected NOAA weather channel.
Cancel the menu selection and/or keypad entry.

Secondary use

Hold down the [16/9] key while pressing the [WX] key to change the mode from USA to International or Canadian.

[ENT] Key

This key functions as the enter key.

⑧ SPEAKER

The internal speaker is located here.

⑨ [DISTRESS] KEY

Used to send a DSC Distress call.

13.2 INTERCOM OPERATION

13.2.1 Communication

1. Press one of the Soft key briefly to appear the key functions at the LCD bottom, then press the [IC] key to activate the “Intercom” mode.

2. If your **FM-4000** is equipped with two Remote MICs, use the [▼]/[▲] key to select the station (**RADIO**, **RAM**, or **ALL**) you wish to communicate with, then press the [ENT] key.

3. When the “Intercom” feature is activated, “Intercom” appears on the **FM-4000** and **CMP30**.

4. Press the **PTT** switch and “TALK” is displayed.

NOTE: A warning beep is emitted when the Remote MIC’s **PTT** switch is pressed while the transceiver microphone’s **PTT** switch is pressed.

5. Speak slowly and clearly into the microphone, holding the microphone about 1/2 inch away from your mouth.

6. When finished, release the **PTT** switch.

7. Press the [CLR(WX)] key again to revert to the “RADIO” mode.



(FM-4000 display)



(CMP30 display)

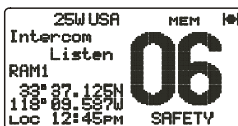

(CMP30's PTT switch is pressed)



(FM-4000's PTT switch is pressed)

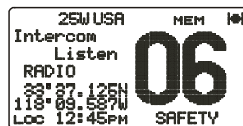

13.2.2 Calling

Press and hold the [DW(IC)] key for one second when the “Intercom” mode is active. A calling beep is emitted from the speaker.

13.3 KEY ASSIGNMENT

13.3.1 Number of Soft Keys

Three soft keys are set as default. However the Remote MIC allows assigning of up to six soft keys with the instructions below:

1. Press and hold down the [CALL(MENU)] key until “Radio Setup” menu appears.
2. Press the [ENT] key, then press the [▼] key to select “SOFT Keys.”
3. Press the [ENT] key.
4. Press the [▲] or [▼] key to select “Number of SOFT Keys” and press the [ENT] key.
5. Press the [▲] or [▼] key to select the number of soft keys (3, 4, or 6) and press the [ENT] key.
6. To exit this menu and return to radio operation mode, press the [16/9] key.

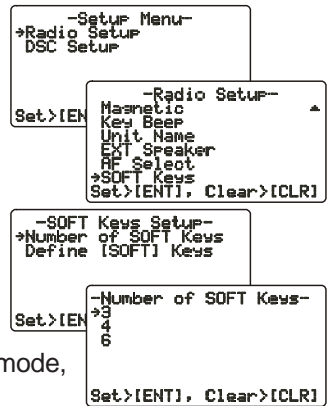

13.3.2 Define the Soft Keys

By default the soft keys are assigned as SCAN, DW and NAV, however their function can be changed. In addition the soft keys can be increased or reassigned as follows:

1. Press and hold down the [CALL(MENU)] key until “Radio Setup” menu appears.
2. Press the [ENT] key, then press the [▼] key to select “SOFT Keys.”
3. Press the [ENT] key.
4. Press the [▼] key to select “Define [SOFT] Keys” and press the [ENT] key.
5. Press the [▲] or [▼] key to select the [Soft] key, and press the [ENT] key. Then, press the [▲] or [▼] key to select the new function to be assigned, and press the [ENT] key. Available functions are listed below.
6. To exit this menu and return to radio operation mode, press the [16/9] key.

DISPLAY	FUNCTION
SCAN	Stops and starts scanning.
DW	Stops and starts Dual Watch Scan.
MEM	When pressed memorizes a channel for scanning.
IC	Activates the Intercom function.
PA	Operates the PA function.
FOG	Operates the Fog Horn function.
SCRM	Toggles the Voice Scrambler “on” and “off”.

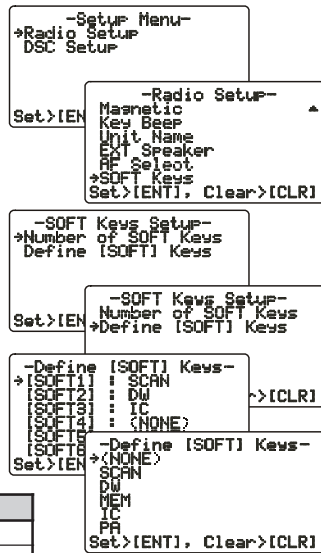

13.4 EXTERNAL SPEAKER AF SELECTION

The “AF Select” menu allows you to set the audio output level of the Remote MIC’s External Speaker to a fixed level regardless of the VOL level setting of the Remote MIC, which is useful when using the amplified speaker (not option) with on/off volume control.

1. Press and hold down the [CALL(MENU)] key until “Radio Setup” menu appears.
2. Press the [ENT] key, then use the [▲]/[▼] key to select “AF Select.”
3. Press the [ENT] key.
4. Press the [▲] or [▼] key to select “Pr” (External Speaker Level is “Fixed”) or “Po” (External Speaker Level is “Adjustable”).
5. Press the [ENT] key to store the data entered, then press the [16/9] key to exit this menu and return to radio operation mode.

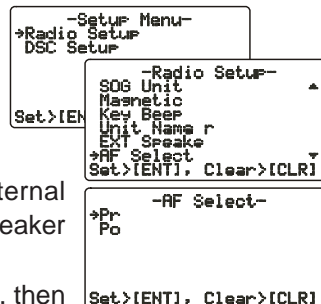

13.5 DSC/RADIO SETUP MODE

The Remote MIC can access the DSC SETUP / RADIO SETUP menu (see section “11 DIGITAL SELECTIVE CALLING” and section “12 RADIO SETUP MENU” for details). However, the Dimmer, Contrast, and Key Beep menu items which are accessed from the Remote MIC only controls the Remote MIC’s display and speaker.

DSC SETUP /RADIO SETUP menu from the Remote MIC:

1. Press and hold down the [CALL(MENU)] key until “Radio Setup” menu appears.
2. Press the [▲]/[▼] key to select “Radio Setup” or “DSC Setup.”
3. Press the [ENT] key, then use the [▲]/[▼] key to select the menu item you wish to work on.
4. Press the [ENT] key.
5. Press the [▲]/[▼] key to change the value or condition for the menu item, then press the [ENT] key to save the new setting.
6. Press the [16/9] key to return to the normal operation.

```

-Setup Menu-
>Radio Setup
DSC Setup

Set>[ENT], Clear>[CLR]
    
```

```

- Radio Setup-
>Dimmer
Contrast
SOG Unit
Magnetic
Key Beep
Unit Name
Set>[ENT], Clear>[CLR]
    
```

```

-Dimmer-
>High
Dimmer
Set>[ENT], Clear>[CLR]
    
```

Radio Setup	Function
Dimmer	Adjusts the backlight.
Contrast	Adjusts display contrast.
SOG Unit	Selects SOC unit, knots, MPH or KPH.
Magnetic	Selects COG indication format, True or Magnetic.
Key Beep	Turns key beep on or off.
Unit Name	Allows changing the name of the connected MIC.
EXT Speaker	Selects the speaker to use, Internal or External.
AF Select	Selects the audio output,
Soft Keys	Sets the key assignment.

DSC SETUP	Function
Individual Directory	Sets the Individual Directory.
Individual Reply	Sets how to reply to an Individual call, Automatic or Manual.
Individual Ack	Sets how to acknowledge an Individual call, Able or Unable.
Individual Ringer	Selects individual call ringer tone, among four choices.
Group Directory	Setup the Group Directory.
Position Reply	Selects how to respond to request for your position, Automatic or Manual.
Position Input	Sets the latitude/longitude of your vessel manually.
DSC BEEP	Turns on or off the Individual, Group, Position request or send beep.

14 MAINTENANCE

The inherent quality of the solid-state components used in this transceiver will provide many years of continuous use. Taking the following precautions will prevent damage to the transceiver.

- Keep the microphone connected or the jack covered at all times to prevent corrosion of electrical contacts.
- Never key the microphone unless an antenna or suitable dummy load is connected to the transceiver.
- Ensure that the supply voltage to the transceiver does not exceed 16 VDC or fall below 11 VDC.
- Use only FURUNO-approved accessories and replacement parts.

In the unlikely event of serious problems, please contact your dealer.

14.1 TROUBLESHOOTING CHART

SYMPTOM	PROBABLE CAUSE	REMEDY
Cannot power the transceiver.	No DC voltage to the transceiver, or blown fuse.	a. Check the battery connections and the fuse. b. The PWR switch needs to be pressed and held to turn the radio on.
Transceiver blows fuse when connected to power supply.	Reversed power wires.	Check the power cable for DC voltage. Check the fuse (6A 250V). Make sure the red wire is connected to the positive (+) battery post, and the black wire is connected to the negative (-) battery post. If the fuse blows after replacement, contact your dealer for advice.
Popping or whining noise from the speaker while engine runs.	Engine noise.	Reroute the DC power cables away from the engine. Add noise suppressor on the power cable. Change to resistive spark plug wires and/or add an alternator whine filter.
Sound is not emitted from the internal or external speaker.	Accessory cable.	Check if the accessory cable is firmly fastened. (Short circuit the external speaker cable WHITE/SHIELD).
Sound is not emitted from the PA speaker.	Accessory cable.	Check if the accessory cable is firmly fastened. (Short circuit the PA speaker cable RED/SHIELD).
Receiving station reports low TX power, even with transceiver set to HI power.	Antenna.	Have the antenna checked or test the transceiver with another antenna. If the problem persists, contact your dealer for advice.
"HI BATTERY" or "LO BATTERY" appears when the power is turned on.	The power supply voltage is too high or too low.	Confirm that the connected power supply voltage is not over 17 volts or lower than 10 volts.
"PA ERROR" or "FOG ERROR" is shown when the PA/FOG mode is activated.	Accessory cable.	Check if the accessory cable is firmly fastened. (Short circuit the PA speaker cable RED/SHIELD).
Your position is not displayed.	Accessory cable.	Check if the accessory cable is firmly fastened. Some GPS receivers use the battery ground line for NMEA connection.
	Setting at the GPS receiver.	Check the output signal format of the GPS receiver. This radio requires NMEA0183 format with GLL, RMB, or RMC sentence as an output signal. If the GPS receiver has a facility for setting baud rate and parity, select "4800" and "NONE," respectively.
While in PA or Fog listen-back modes, AM broadcasts can be heard.	Strong AM radio stations are being pickup up by the speaker wires.	Replace the speaker wires to a sheilded 2-conductor wire. See section " 8.5 ACCESSORY CABLE " for cable connections.

15 CHANNEL ASSIGNMENTS

This chapter provides the VHF Marine Channel assignments for U.S.A. and International use. Below are listed some data about the charts.

1. VTS. Where indicated, these channels are part of the U.S. Coast Guard's **Vessel Traffic System**.
2. Alpha channel numbers, that is, channel numbers followed by the letter A (such as Channel 07**A**) are **simplex** channels on the U.S.A. or Canadian channel assignments whose counterparts in the International assignments are **duplex** channels. International channels do not use "alpha" numbers. If you call the Coast Guard on Channel 16, they will sometimes ask you to "**go to channel 22 Alpha**." This is a channel assigned to U.S.A., and Canadian Coast Guards for handling distress and other calls. If your radio is set for **International** operation you will go to Channel 22 instead of 22**A**, and will not be able to communicate with the Coast Guard. To use Channel 22**A**, your radio must be set for **USA** or **Canada** operation, usually by a U/I/C (USA/International/Canada) control or combination of controls. Channel 22 (without an "A") is an **International** duplex channel for port operations. Some radios indicate an "A" adjacent to the alpha channels on the display; on others "alpha" is not indicated but the proper channel is selected based on the U/I/C setting.
3. Bridge-to-Bridge channels (for example, Channel 13) are for use by bridge operators on intercoastal waterways and rivers. It is also used by marine vessels in the vicinity of these bridges for navigation and for communicating with the bridge operators. Note that a limit of 1 Watt is specified for these channels. See page 27 for additional information.
4. The **S/D** column on the chart indicates either S (simplex) or D (duplex). **Simplex** means transmitting and receiving on the same frequency. Only one party at a time can talk, unlike a telephone. Be sure to say "**over**" and release your microphone push-to-talk switch at the end of each transmission. **Duplex** operation involves the use of one frequency for transmitting and a separate frequency for receiving. On channels specified as duplex on the charts, correct mode of operation is established automatically by your radio when you select a channel; you cannot change the mode. And you still must release the push-to-talk switch after each transmission in order to listen to the radio.
5. Channels normally used by recreational boaters are those that include the term "non-commercial" in the **Channel Use** column of the chart. Some of these are shared with other users and some are used only in certain geographic regions.
6. Marine vessels equipped with VHF radios are required to monitor Channel 16.

VHF MARINE CHANNEL CHART							
CH	U	C	I	S/D	TX	RX	CHANNEL USE
01		X	X	D	156.050	160.650	Public Correspondence (Marine Operator)
01A	X			S	156.050		Port Operation and Commercial. VTS in selected areas
02		X	X	D	156.100	160.700	Public Correspondence (Marine Operator)
03		X	X	D	156.150	160.750	Public Correspondence (Marine Operator)
03A	X			S	156.150		U.S. Government Only, Coast Guard
04			X	D	156.200	160.800	Public Correspondence (Marine Operator), Port operation, ship movement
04A		X		S	156.200		Pacific coast: Coast Guard, East Coast: Commercial fishing
05			X	D	156.250	160.850	Public Correspondence (Marine Operator), Port operation, ship movement
05A	X	X		S	156.250		Port operation. VTS in Seattle
06	X	X	X	S	156.300		Inter-ship Safety
07			X	D	156.350	160.950	Public Correspondence (Marine Operator), Port operation, ship movement
07A	X	X		S	156.350		Commercial
08	X	X	X	S	156.400		Commercial (Inter-ship only)
09	X	X	X	S	156.450		Boater Calling channel, Commercial & Non-commercial (Recreational)
10	X	X	X	S	156.500		Commercial
11	X	X	X	S	156.550		Commercial. VTS in selected areas.
12	X	X	X	S	156.600		Port operation. VTS in selected areas.
13	X	X	X	S	156.650		Inter-ship Navigation Safety (Bridge-to-bridge)
14	X	X	X	S	156.700		Port operation. VTS in selected areas.
15	X			S	- - -	156.750	Environmental (Receive only)
15		X	X	S	156.750		Commercial, non-commercial, ship movement (1 W)
16	X	X	X	S	156.800		International Distress, Safety and Calling
17	X	X	X	S	156.850		State Controlled (1 W)
18			X	D	156.900	161.500	Port operation, ship movement
18A	X	X		S	156.900		Commercial
19			X	D	156.950	161.550	Port operation, ship movement
19A	X			S	156.950		US: Commercial
19A		X		S	156.950		Coast Guard
20	X	X	X	D	157.000	161.600	Canadian Coast Guard Only, International: port operations and shipment
20A	X			S	157.000		Port operation
21			X	D	157.050	161.650	Port operation, ship movement
21A	X	X		S	157.050		U.S. Government Only, Canadian Coast Guard
22			X	D	157.100	161.700	Port operation, ship movement
22A	X	X		S	157.100		US and Canadian Coast Guard Liaison and Maritime Safety Information Broadcasts announced on channel 16
23		X	X	D	157.150	161.750	Public Correspondence (Marine Operator)
23A	X			S	157.150		U.S. Government Only
24	X	X	X	D	157.200	161.800	Public Correspondence (Marine Operator)
25	X	X	X	D	157.250	161.850	Public Correspondence (Marine Operator)
26	X	X	X	D	157.300	161.900	Public Correspondence (Marine Operator)
27	X	X	X	D	157.350	161.950	Public Correspondence (Marine Operator)
28	X	X	X	D	157.400	162.000	Public Correspondence (Marine Operator)

VHF MARINE CHANNEL CHART							
CH	U	C	I	S/D	TX	RX	CHANNEL USE
60		X	X	D	156.025	160.625	Public Correspondence (Marine Operator)
61			X	D	156.075	160.675	Public Correspondence (Marine Operator), Port operation, ship movement
61A	X	X		S	156.075		Public Coast: Coast Guard; East Coast: commercial fishing only
62			X	D	156.125	160.725	Public Correspondence (Marine Operator), Port operation, ship movement
62A		X		S	156.125		Public Coast: Coast Guard; East Coast: commercial fishing only
63			X	D	156.175	160.775	Public Correspondence (Marine Operator), Port operation, ship movement
63A	X	X		S	156.175		Port Operation and Commercial. VTS in selected areas.
64		X	X	D	156.225	160.825	Public Correspondence (Marine Operator), Port operation, ship movement
64A	X	X		S	156.225		Public Correspondence (Marine Operator), Port operation, ship movement
65			X	D	156.275	160.875	Public Correspondence (Marine Operator), Port operation, ship movement
65A	X	X		S	156.275		Port Operations
66			X	D	156.325	160.925	Public Correspondence (Marine Operator), Port operation, ship movement
66A	X	X		S	156.325		Port Operations
67	X	X	X	S	156.375		US: Commercial. Used for Bridge-to-bridge com- muni-cations in lower Mississippi River. Inter-ship only, Canada: Commercial fishing, S&R
68	X	X	X	S	156.425		Non-commercial (Recreational)
69	X	X	X	S	156.475		US: Non-commercial (Recreational), Canada: Commercial fishing only, International: Inter-ship, Port operations and Ship movement
70	X	X	X	S	156.525		Digital selective calling (voice communications not allowed)
71	X	X	X	S	156.575		US, Canada: Non-commercial (Recreational), International: Port operations and Ship movement
72	X	X	X	S	156.625		Non-commercial (Inter-ship only)
73	X	X	X	S	156.675		US: Port Operations, Canada: Commercial fish ing only, International: Inter-ship, Port operations and Ship movement
74	X	X	X	S	156.725		US: Port Operations, Canada: Commercial fishing only, International: Inter-ship, Port operations and Ship movement
75	X	X	X	S	156.775		Port Operations (Inter-ship only) (1W)
76	X	X	X	S	156.825		Port Operations (Inter-ship only) (1W)
77	X	X		S	156.875		Port Operations (Inter-ship only) (1W)
77			X	S	156.875		Port Operations (Inter-ship only)
78			X	D	156.925	161.525	Public Correspondence (Marine Operator), Port operation, ship-movement
78A	X	X		S	156.925		Non-commercial (Recreational)
79			X	D	156.975	161.575	Port operation and Ship movement
79A	X	X		S	156.975		Commercial

VHF MARINE CHANNEL CHART							
CH	U	C	I	S/D	TX	RX	CHANNEL USE
80			X	D	157.025	161.625	Port operation, ship movement
80A	X	X		S	157.025		Commercial
81			X	D	157.075	161.675	Port operation, ship movement
81A	X			S	157.075		U.S. Government Only - Environmental protection operations.
81A		X		S	157.075		Canadian Coast Guard Only
82			X	D	157.125	161.725	Public Correspondence (Marine Operator), Port operation, ship movement
82A	X	X		S	157.125		U.S. Government Only, Canadian Coast Guard Only
83		X		D	157.175	161.775	Canadian Coast Guard Only
83			X	D	157.175	161.775	Public Correspondence (Marine Operator)
83A	X	X		S	157.175		U.S. Government Only, Canadian Coast Guard Only
84	X	X	X	D	157.225	161.825	Public Correspondence (Marine Operator)
85	X	X	X	D	157.275	161.875	Public Correspondence (Marine Operator)
86	X	X	X	D	157.325	161.925	Public Correspondence (Marine Operator)
87		X	X	S	157.375		Port operation, ship movement
87A	X			S	157.375		Public Correspondence (Marine Operator)
88		X	X	S	157.425		Port operation, ship movement
88A	X			S	157.425		Commercial, Inter-ship Only
WX01	X	X	X	D	---	162.550	Weather (receive only)
WX02	X	X	X	D	---	162.400	Weather (receive only)
WX03	X	X	X	D	---	162.475	Weather (receive only)
WX04	X	X	X	D	---	162.425	Weather (receive only)
WX05	X	X	X	D	---	162.450	Weather (receive only)
WX06	X	X	X	D	---	162.500	Weather (receive only)
WX07	X	X	X	D	---	162.525	Weather (receive only)
WX08	X	X	X	D	---	161.650	Weather (receive only)
WX09	X	X	X	D	---	161.775	Weather (receive only)
WX10	X	X	X	D	---	163.275	Weather (receive only)

NOTE: Simplex channels, 3A, 21A, 23A, 61A, 64A, 81A, 82A and 83A CANNOT be lawfully used by the general public in U.S.A. waters.

Channel designator	Carrier frequency (MHz)		Points of communication (Intership and between coast and ship unless otherwise indicated)	
	Ship transmit	Coast transmit		
Port Operations				
01A ¹	156.050	156.050	Intership only.	
63A ¹	156.175	156.175		
05 ²	156.250	156.250		
65A	156.275	156.275		
66A	156.325	156.325		
12 ³	156.600	156.600		
73	156.675	156.675		
14 ³	156.700	156.700		
74	156.725	156.725		
77 ⁴	156.875			
20	157.000	161.600		
20A ¹²	157.000			
Navigational (Bridge-to-Bridge)⁵				
13 ⁶	156.650	156.650		
67 ⁷	156.375	156.375		
Commercial				
01A ¹	156.050	156.050	Intership only. Do.	
63A ¹	156.175	156.175		
07A	156.350	156.350		
67 ⁷	156.375			
08	156.400		
09	156.450	156.450		
10	156.500	156.500		
11 ³	156.550	156.550		
18A	156.900	156.900		
19A	156.950	156.950		
79A	156.975	156.975		
80A	157.025	157.025		
88A ⁸	157.425		
72 ¹⁴	156.625		
Digital Selective Calling				
70 ¹⁵	156.525	156.525		

Channel designator	Carrier frequency (MHz)		Points of communication (Intership and between coast and ship unless otherwise indicated)	
	Ship transmit	Coast transmit		
Noncommercial				
68 ¹⁷	156.425	156.425	Intership only. Great Lakes only. Do. Internship only.	
09 ¹⁶	156.450	156.450		
69	156.475	156.475		
71	156.575	156.575		
72	156.625		
78A	156.925	156.925		
79A	156.975	156.975		
80A	157.025	157.025		
67 ¹⁴	156.375		
Distress, Safety and Calling				
16	156.800	156.800		EPRIB
Intership Safety				
06	156.300		a. Intership, or b. For SAR: Ship and aircraft for the U.S. Coast Guard.
Environmental				
15 ¹³	156.750	Coast to ship only.	
Maritime Control				
17 ^{9,10}	156.850	156.850		
Liaison, U.S. Coast Guard				
22A ¹¹	157.100	157.100	Ship, aircraft, and coast stations of the U.S. Coast Guard and at Lake Mead, Nev., ship and coast stations of the National Park Service, U.S. Department of the Interior.	

- 1: 156.050 MHz and 156.175 MHz are available for port operations and commercial communications purposes when used only within the U.S. Coast Guard designated Vessel Traffic Services (VTS) area of New Orleans, on the lower Mississippi River from the various pass entrances in the Gulf of Mexico to Devil's Swamp Light at River Mile 242.4 above head of passes near Baton Rouge.
- 2: 156.250 MHz is available for port operations communications use only within the U.S. Coast Guard designated VTS radio protection areas of New Orleans and Houston described in Sec. 80.383. 156.250 MHz is available for intership port operations communications used only within the area of Los Angeles and Long Beach harbors, within a 25-nautical mile radius of Point Fermin, California.
- 3: 156.550 MHz, 156.600 MHz and 156.700 MHz are available in the U.S. Coast Guard designated port areas only for VTS communications and in the Great Lakes available primarily for communications relating to the movement of ships in sectors designated by the St. Lawrence Seaway Development Corporation or the U.S. Coast Guard. The use of these frequencies outside VTS and ship movement sector protected areas is permitted provided they cause no interference to VTS and ship movement communications in their respective designated sectors.

- 4: Use of 156.875 MHz is limited to communications with pilots regarding the movement and docking of ships. Normal output power must not exceed 1 watt.
- 5: 156.375 MHz and 156.650 MHz are available primarily for intership navigational communications. These frequencies are available between coast and ship on a secondary basis when used on or in the vicinity of locks or drawbridges. Normal output power must not exceed 1 watt. Maximum output power must not exceed 10 watts for coast stations or 25 watts for ship stations.
- 6: On the Great Lakes, in addition to bridge-to-bridge communications, 156.650 MHz is available for vessel control purposes in established vessel traffic systems. 156.650 MHz is not available for use in the Mississippi River from South Pass Lighted Whistle Buoy "2" and Southwest Pass entrance Midchannel Lighted Whistle Buoy to mile 242.4 above Head of Passes near Baton Rouge. Additionally it is not available for use in the Mississippi River-Gulf Outlet, the Mississippi River-Gulf Outlet Canal, and the Inner Harbor Navigational Canal, except to aid the transition from these areas.
- 7: Use of 156.375 MHz is available for navigational communications only in the Mississippi River from South Pass Lighted Whistle Buoy "2" and Southwest Pass entrance Midchannel Lighted Whistle Buoy to mile 242.4 above head of Passes near Baton Rouge, and in addition over the full length of the Mississippi River-Gulf Outlet Canal from entrance to its junction with the Inner Harbor Navigation Canal, and over the full length of the Inner Harbor Navigation Canal from its junction with the Mississippi River to its entry to Lake Pontchartrain at the New Seabrook vehicular bridge.
- 8: Within 120 km (75 miles) of the United States/Canada border, in the area of the Puget Sound and the Strait of Juan de Fuca and its approaches, 157.425 MHz is half of the duplex pair designated as Channel 88. In this area, Channel 88 is available to ship stations for communications with public coast stations only. More than 120 km (75 miles) from the United States/Canada border in the area of the Puget Sound and the Strait of Juan de Fuca, its approaches, the Great Lakes, and the St. Lawrence Seaway, 157.425 MHz is available for intership and commercial communications. Outside Puget Sound area and its approaches and the Great Lakes, 157.425 MHz is also available for communications between commercial fishing vessels and associated aircraft while engaged in commercial fishing activities.
- 9: When the frequency 156.850 MHz is authorized, it may be used additionally for search and rescue training exercises conducted by state or local governments.
- 10: The frequency 156.850 MHz is additionally available to coast stations on the Great Lakes for transmission of scheduled Coded Marine Weather Forecasts (MAFOR), Great Lakes Weather Broadcast (LAWEB) and unscheduled Notices to Mariners or Bulletins. F3C and J3C emissions are permitted. Coast Stations on the Great Lakes must cease weather broadcasts which cause interference to stations operating on 156.800 MHz until the interference problem is resolved.
- 11: The frequency 157.100 MHz is authorized for search and rescue training exercises by state or local government in conjunction with U.S. Coast Guard stations. Prior U.S. Coast Guard approval is required. Use must cease immediately on U.S. Coast Guard request.
- 12: The duplex pair for channel 20 (157.000/161.600 MHz) may be used for ship to coast station communications.
- 13: Available for assignment to coast stations, the use of which is in accord with an agreed program, for the broadcast of information to ship stations concerning the environmental conditions in which vessels operate, i.e., weather; sea conditions; time signals; notices to mariners; and hazards to navigation.
- 14: Available only in the Puget Sound and the Strait of Juan de Fuca.
- 15: The frequency 156.525 MHz is to be used exclusively for distress, safety and calling using digital selective calling techniques. No other uses are permitted.
- 16: The frequency 156.450 MHz is available for intership, ship and coast general purpose calling by noncommercial vessels, such as recreational boats and private coast stations.
- 17: The frequency 156.425 MHz is assigned by rule to private coast stations in Alaska for facsimile transmissions as well as voice communications.

16 SPECIFICATIONS

Performance specifications are nominal, unless otherwise indicated, and are subject to change without notice.

16.1 GENERAL

Channels	All USA, International and Canadian
Input Voltage	13.8 VDC \pm 20%
Current Drain	
Standby	0.5 A
Receive	1.5 A
Transmit	5.0 A (Hi); 1.5 A (Lo)
Dimensions	3.5" H x 9.1" W x 5.9" D (90 H x 230 W x 150 D mm)
Flush-Mount Dimensions	2.8" H x 8.1" W x 5.1" D (72 H x 205 W x 130 D mm)
Weight	3.2 lbs (1.45 kg)

16.2 TRANSMITTER

Frequency Range	156.025 to 157.425 MHz
RF Output	25 W (Hi); 1 W (Lo)
Conducted Spurious Emissions	80 dB (Hi); 66 dB (Lo)
Audio Response	within +1/-3 of a 6 dB/octave pre-emphasis characteristic at 300 to 3000 Hz
Audio Distortion	5 %
Modulation	16K0G3E, for DSC 16K0G2B
Frequency Stability (-4 °F to +140 °F; -20 °C to +60 °C)	\pm 0.0005%
FM Hum and Noise	50 dB

16.3 RECEIVER

Frequency Range	156.050 to 163.275 MHz
Sensitivity	
20 dB Quieting	0.35 μ V
12 dB SINAD	0.30 μ V
Squelch Sensitivity (Threshold)	0.13 μ V
Modulation Acceptance Bandwidth	\pm 7.5 kHz
Selectivity (Typical)	
Spurious and Image Rejection	-80 dB
Intermodulation and Rejection at 12 dB SINAD	-80 dB
Audio Output	4.5 W
Audio Response	within + 1/-3 of a 6 dB/octave de-emphasis characteristic at 300 to 3000 Hz
Frequency Stability (-4 °F to +140 °F; -20 °C to +60 °C)	\pm 0.0005 %
Channel Spacing	25 kHz
DSC Format	EN 301 025
NMEA Input/Output	Output - DSC, DSE Input - GLL, GGA, RMC and GNS

FURUNO ELECTRIC CO., LTD.

9-52 Ashihara-cho,
Nishinomiya, 662-8580, JAPAN

Telephone : +81-(0) 798-65-2111
Fax : +81-(0) 798-65-4200

• FURUNO Authorized Distributor/Dealer