

FURUNO

OPERATOR'S MANUAL

SSB RADIOTELEPHONE

FS-1570 (150 W)

MODEL FS-2570 (250 W)



FURUNO ELECTRIC CO., LTD.
NISHINOMIYA, JAPAN

© **FURUNO ELECTRIC CO., LTD.**

9-52 Ashihara-cho,
Nishinomiya, Japan

Telephone : 0798-65-2111

Telefax : 0798-65-4200

Your Local Agent/Dealer

All rights reserved.

Printed in Japan

PUB.No. OME-56360

(DAMI) FS-1570/2570

FIRST EDITION : OCT. 2002

C : FEB. 03,2003



00080933800



OME56360C0

Distress Alert Calling Procedure

Below is the procedure for transmitting a distress alert via radiotelephone. Transmit the distress alert when a life-endangering situation occurs on your vessel.

1. Open the DISTRESS button cover and press the [DISTRESS] button more than three seconds to show the following display, then release the [DISTRESS] button.

Distress call in progress!	
NATURE: UNDESIGNATED	
POS: 12°34N 123°45E AT 12:34	
TELEPHONE	2182.0 KHZ
DSC FREQ :	2187.5 KHZ
TIME TO GO :	30S

2. After the distress call has been transmitted, the following displays appear in order.

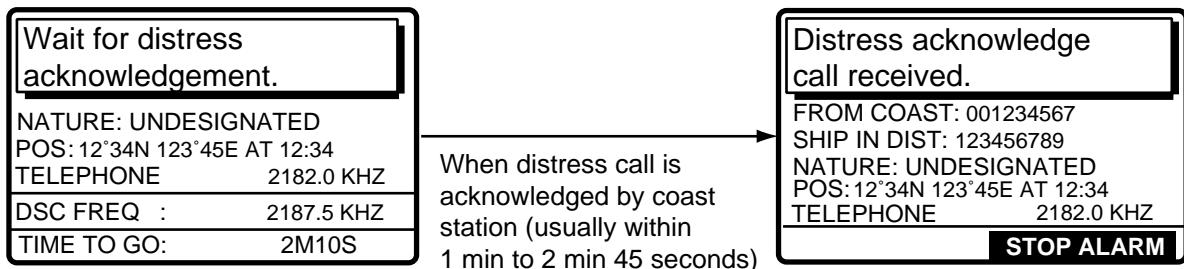

3. The audio alarm sounds; press the [CANCEL] key to silence the alarm.
4. Communicate with the coast station via radiotelephone as below. (In the dual control unit system, communication can be done from any control unit, after the distress alert has been transmitted. To restore priority to the #1 control unit after completion of distress communications, turn it off and on again.)
 - a) Say MAYDAY three times.
 - b) Say "This is ..." name of your vessel and your call sign three times.
 - c) Give nature of distress and assistance needed.
 - d) Give description of your vessel (type, number of persons onboard, etc.) and any other information which may aid in rescue.



SAFETY INSTRUCTIONS



DANGER

Never touch the SSB antenna, antenna coupler or lead-in insulator when the SSB radiotelephone is transmitting.

High voltage which will cause death or serious injury is present at the locations shown in the illustration below when the SSB radiotelephone is transmitting.

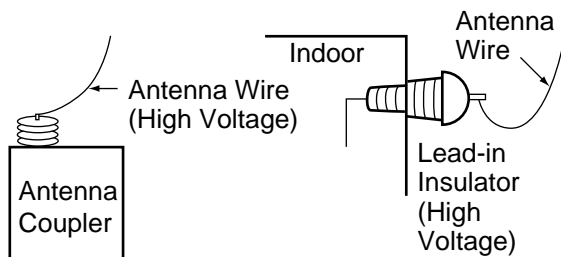

WARNING



ELECTRICAL SHOCK HAZARD
Do not open the equipment.

Only qualified personnel should work inside the equipment.

Immediately turn off the power at the switchboard if water leaks into the equipment or something is dropped in the equipment.

Continued use of the equipment can cause fire or electrical shock. Contact a FURUNO agent for service.

Do not disassemble or modify the equipment.

Fire, electrical shock or serious injury can result.

Immediately turn off the power at the switchboard if the equipment is emitting smoke or fire.

Continued use of the equipment can cause fire or electrical shock. Contact a FURUNO agent for service.

Do not operate the equipment with wet hands.

Electrical shock can result.



CAUTION

Use the proper fuse.

Use of the wrong fuse can cause serious damage to the equipment and void the warranty.

 **CAUTION**

Do not operate the [DISTRESS] button except in case of a life-endangering situation on your vessel.

If the distress alert is accidentally transmitted, contact the nearest coast station and inform them of the accidental transmission as follows:

- a) Ship's name
- b) Ship's call sign and DSC number
- c) Position at time of transmission
- d) Time of transmission

This equipment is intended for maritime use. Do not use it in other applications.

WARNING LABEL

A warning label is attached to the transceiver unit and a danger label is attached to the antenna coupler.

Do not remove the labels.

If a label is missing or illegible, contact a FURUNO agent or dealer about replacement.

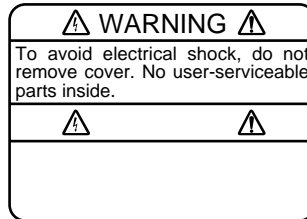

Name: Warning Label (1)
Type: 86-003-1011-1
Code No.: 100-236-231

**TRANSCEIVER
UNIT**

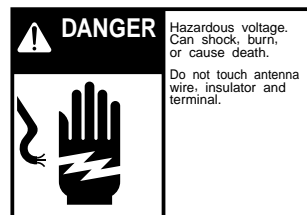

Name: Danger Label
Type: 05-062-0213-0
Code No.: 100-199-230

**ANTENNA
COUPLER**

TABLE OF CONTENTS

TABLE OF CONTENTS	iv
FOREWORD	ix
SYSTEM CONFIGURATION	xi
SPECIFICATIONS	SP-1
1 OPERATIONAL OVERVIEW	1-1
1.1 Controls	1-1
1.2 Turning the Power On/Off	1-2
1.3 Panel Dimmer, LCD Contrast	1-2
1.4 Indications	1-3
1.4.1 DSC standby screen	1-3
1.4.2 Radiotelephone screen	1-3
1.5 Loudspeaker	1-4
1.6 Scanning Routine DSC Frequencies	1-4
1.7 Automatic Acknowledge On/Off	1-4
1.8 Manual Entry of Position and Time	1-5
1.9 System Characteristics	1-7
1.9.1 Equipment priority	1-7
1.9.2 Controls become inoperative	1-7
1.9.3 Controls become operative	1-7
1.9.4 Automatic setting of working frequency	1-7
1.10 Power Supply Unit (option)	1-8
2 SSB RADIOTELEPHONE	2-1
2.1 Transmitting	2-1
2.1.1 Choosing class of emission	2-1
2.1.2 Choosing channel, frequency	2-2
2.1.3 Tuning	2-3
2.1.4 Using the handset	2-4
2.1.5 Monitoring transceiver output power	2-4
2.1.6 Reducing transmitter power	2-5
2.1.7 Displaying IA, IC, VC or RF	2-5
2.2 Receiving	2-6
2.2.1 RF gain (sensitivity) adjustment	2-6
2.2.2 S-meter	2-6
2.2.3 Monitoring traffic on intended transmit frequency	2-6
2.2.4 Receiving AM broadcasting stations	2-6
2.2.5 Squelch control, squelch frequency	2-7
2.2.6 Noise blanker	2-7
2.3 Intercom	2-8
2.4 Telex Communications	2-8
2.5 When Automatic Tuning Fails	2-9

2.6 User Channels	2-10
2.6.1 Registering user channels.....	2-10
2.6.2 Deleting user channels.....	2-12
2.7 FAX Enable/Disable	2-12
2.8 Speaker Setting in Off Hook	2-13
3 DSC OVERVIEW	3-1
3.1 What is DSC?	3-1
3.2 DSC Call.....	3-1
3.2.1 Distress alert call and reply	3-3
3.2.2 Individual call	3-4
3.3 Audio Alarms.....	3-4
3.4 Interpreting Call Displays	3-5
3.4.1 Receive calls.....	3-5
3.4.2 Send calls	3-7
4 DISTRESS OPERATIONS	4-1
4.1 Sending Distress Alert.....	4-1
4.1.1 Sending distress alert by DISTRESS button, nature of distress not specified....	4-1
4.1.2 Sending distress alert by DISTRESS button, nature of distress specified.....	4-3
4.2 Receiving a Distress Alert	4-6
4.2.1 Distress alert received on MF band.....	4-7
4.2.2 Distress alert received on HF band	4-9
4.3 Sending Distress Relay on Behalf of a Ship in Distress.....	4-13
4.3.1 Sending distress relay to coast station	4-13
4.3.2 Sending distress relay to all ships	4-16
4.4 Receiving Distress Relay All Ships.....	4-19
4.5 Receiving Distress Relay from Coast Station	4-19
5 CALLING, RECEIVING.....	5-1
5.1 All Ships Call	5-1
5.1.1 Sending an all ships call.....	5-1
5.1.2 Receiving an all ships call	5-3
5.2 Individual Call.....	5-4
5.2.1 Sending an individual call.....	5-4
5.2.2 Receiving an individual call	5-10
5.3 Group Call.....	5-15
5.3.1 Sending a group call	5-15
5.3.2 Receiving a group call.....	5-18
5.4 Geographical Area Call	5-19
5.4.1 Sending a geographical area call	5-19
5.4.2 Receiving a geographical area call.....	5-22
5.5 Neutral Craft Call.....	5-23
5.5.1 Sending a neutral craft call.....	5-23
5.5.2 Receiving a neutral craft call	5-25
5.6 Medical Transport Call	5-26
5.6.1 Sending a medical transport call	5-26
5.6.2 Receiving a medical transport call.....	5-27

5.7 Polling Call	5-28
5.7.1 Sending a polling call.....	5-28
5.7.2 Receiving a polling call	5-31
5.8 Position Call	5-33
5.8.1 Position call: requesting other ship's position.....	5-34
5.8.2 Position call: other ship requests your position	5-36
5.9 PSTN Call.....	5-38
5.9.1 Sending a PSTN call, receiving acknowledge back (ACK BQ)	5-38
5.9.2 Receiving a PSTN call, sending acknowledge back (ACK BQ).....	5-42
5.9.3 PSTN call disconnection, receiving charge information (ship disconnects line)	5-43
5.9.4 PSTN call disconnection, receiving charge information (coast station disconnects line).....	5-44
5.10 Log File.....	5-45
5.10.1 Opening a log file.....	5-45
5.11 Erasing Message Files.....	5-46
6 PREPARING TX CALLS	6-1
6.1 Preparing Individual Calls	6-1
6.2 Preparing Group Calls	6-4
6.3 Preparing Geographical Area Calls.....	6-5
6.4 Preparing PSTN Calls.....	6-7
6.5 Preparing Test Calls.....	6-8
6.6 Sending Prepared Calls.....	6-9
6.7 Deleting Send Message Files	6-10
6.8 Printing List of Send Message Files.....	6-10
7 DSC/WATCH RECEIVER SETUP	7-1
7.1 Setting Alarms	7-1
7.2 Auto Ack Menu.....	7-2
7.3 Printing Messages	7-2
7.4 Setting Scan Frequencies.....	7-3
7.4.1 Distress frequencies	7-3
7.4.2 Routine frequencies.....	7-4
7.5 Adjusting Volume	7-5
8 NBDP SYSTEM OVERVIEW.....	8-1
8.1 Turning on the NBDP System	8-1
8.2 Description of Equipment.....	8-2
8.2.1 Terminal unit.....	8-2
8.2.2 Keyboard.....	8-3
8.3 Function Keys, Menu Operation	8-4
8.3.1 Menu conventions	8-4
8.3.2 Menu overview	8-5
8.3.3 Function key description.....	8-6

9	NBDP PREPARATIONS	9-1
9.1	Registering Answerback Code & ID Codes	9-1
9.1.1	Registering answerback code	9-1
9.1.2	Registering ID codes	9-2
9.2	Station List	9-2
9.2.1	Registering stations	9-3
9.2.2	Editing/Deleting stations	9-4
9.3	Timer Programming	9-5
9.3.1	Registering timer programs	9-5
9.3.2	Editing/Deleting timer programs	9-6
9.4	User Channels	9-6
9.4.1	Registering user channels	9-6
9.4.2	Editing/Deleting user channels	9-7
9.5	Scan Channel Groups	9-7
9.5.1	Registering scan channel groups	9-7
9.5.2	Editing/Deleting scan channel groups	9-8
10	NBDP FILE OPERATIONS	10-1
10.1	Opening and Closing Files	10-1
10.2	Creating Files	10-1
10.3	Saving a File	10-3
10.3.1	Formatting floppy disks	10-3
10.3.2	Saving a file	10-4
10.4	Editing Files	10-5
10.4.1	Cutting and pasting text	10-5
10.4.2	Copying and pasting text	10-6
10.4.3	Select all	10-6
10.4.4	Searching text	10-6
10.4.5	Replacing text	10-7
10.4.6	Goto line	10-7
10.4.7	Goto top, Goto bottom	10-8
10.5	Opening Files	10-8
10.5.1	Opening a file	10-8
10.5.2	Switching between files	10-8
10.6	Renaming Files	10-9
10.7	Saving a File Under a New Name	10-9
10.8	Deleting Files	10-9
10.9	Real Time Printing	10-9
10.10	Printing Files	10-10
11	NBDP TRANSMITTING, RECEIVING	11-1
11.1	Manual Calling	11-1
11.2	ARQ Mode Operation	11-3
11.3	FEC Mode Operation	11-5
11.4	Choosing Receive Mode	11-5
11.5	Communication Example	11-6

11.6 Timer Operation	11-8
11.6.1 Enabling timer operation	11-8
11.6.2 Stopping timer operation	11-9
11.7 Scanning.....	11-9
11.8 Communication Buffer.....	11-10
11.9 Preparing Macrofiles for Automatic Telex	11-10
11.9.1 Automatic telex overview	11-10
11.9.2 Preparations	11-11
11.9.3 Commands	11-12
11.9.4 Store-and-forward method	11-13
DIRTLX macrofile	11-15
11.10 Automatic Telex using Macrofile	11-17
12 MAINTENANCE & TROUBLESHOOTING	12-1
12.1 Daily Test.....	12-1
12.2 Radiotelephone Test.....	12-2
12.3 Antenna Coupler Test	12-2
12.4 Maintenance	12-3
12.5 Replacement of Fuses.....	12-4
12.6 Simple Troubleshooting	12-5
12.7 Error Messages	12-5
12.8 Test Call.....	12-7
12.9 NBDP Terminal Unit Maintenance.....	12-9
12.9.1 Cleaning the equipment.....	12-9
12.9.2 Connectors and earth connection	12-9
12.9.3 Floppy disk drive.....	12-9
12.9.4 Diagnostics.....	12-10
APPENDIX	AP-1
Menu Tree	AP-1
Frequency Tables	AP-4
Telex Abbreviations.....	17
Digital Interface (IEC 61162-1).....	AP18
Parts List	AP23
Parts Location	AP26
INDEX.....	IN-1

FOREWORD

Thank you for purchasing the FS-1570 (150 W)/FS-2570 (250 W) SSB Radiotelephone. We are confident you will discover why FURUNO has become synonymous with quality and reliability.

Dedicated in the design and manufacture of marine electronics equipment for over half a century, FURUNO Electric Company has gained an unrivaled reputation as a world leader in the industry. This is the result of our technical excellence as well as our worldwide distribution and service network.

Please carefully read and follow the safety information and operating and maintenance instructions set forth in this manual before attempting to operate the equipment and conduct any maintenance. Your unit will perform to the utmost of its ability only if it is operated and maintained in accordance with the correct procedures.

Note: *The example screens shown in this manual may not match the screens you see on your display. The screen you see depends on your system configuration and equipment settings.*

Features

The FS-1570/FS-2570 is an MF/HF SSB Radiotelephone with a built-in DSC/Watch Receiver, all contained in a surprisingly compact cabinet. An NBDP (Narrow Band Direct Printing) Terminal Unit is optionally available.

Data is displayed on a large, easy-to-read backlit LCD. Operation is simplified by the use of few keys and easy-to-follow menus.

The built-in DSC/watch receiver produces and receives digital selective calls for quick and efficient establishment of distress, urgency, safety and routine communications with other ships and coast stations that install any MF/HF DSC facilities.

The main features are

General

- Fully meets the following regulations: IMO A.694(17), IMO A.804(19), IMO A.806(19), IMO A.813(19), IMO MSC 68(68), IEC 60945, IEC 61907-3/8/9, IEC-61162-1, EIV-300/338, ITU-R M.493-10, M.541-8, M.1082-1, EN 300 373, EN 300 338, EN 300 033 and ETS 300 067.
- One-touch testing facility
- Automatic entry of position with manual override
- Optional printer can automatically print out DSC and NBDP received messages and test results.

DSC/watch receiver

- Distress, safety and routine calling
- Scanning of DSC frequencies for distress and general calls on MF/HF
- File editing capability for readiness in case of emergency
- PSTN (Public Switched Telephone Network) capability standard
- Log stores 50 each of latest ordinary, distress and transmitted messages, in separate memory blocks.

NBDP (with optional NBDP Terminal Unit IB-581/IB-583)

- Automatic error-free telex communications and distress message in compliance with GMDSS requirements
- LCD monitor and keyboard comply with ITU regulations
- Pop-up menus for user-friendly operation
- Memory for 100 operator-customized channels
- Real time message printing with Printer PP-510

Program Number

PC Board	Program No.	On Display	Remarks
MAIN (Transceiver Unit)	0550205101	Ver. 01	FS-1570T/FS-2570T
PANEL 1 (#1 Control Unit)	0550206101	Ver. 01	FS-2570C
PANEL 2 (#2 Control Unit)	0550206101	Ver. 01	Optional unit
MODEM (DSC)	0550207101	Ver. 01	
NBDP MODEM	0550208101	Ver. 01	Optional pcb

Terminal Unit IB-581 (optional unit)

PC Board	Program No.	On Display	Remarks
Terminal Unit	0550210122	Ver. 1.22	

Terminal Unit IB-583 (optional unit)

PC Board	Program No.	On Display	Remarks
Terminal Unit	0550209122	Ver. 1.22	

SYSTEM CONFIGURATION

FS-2570 (250 W)

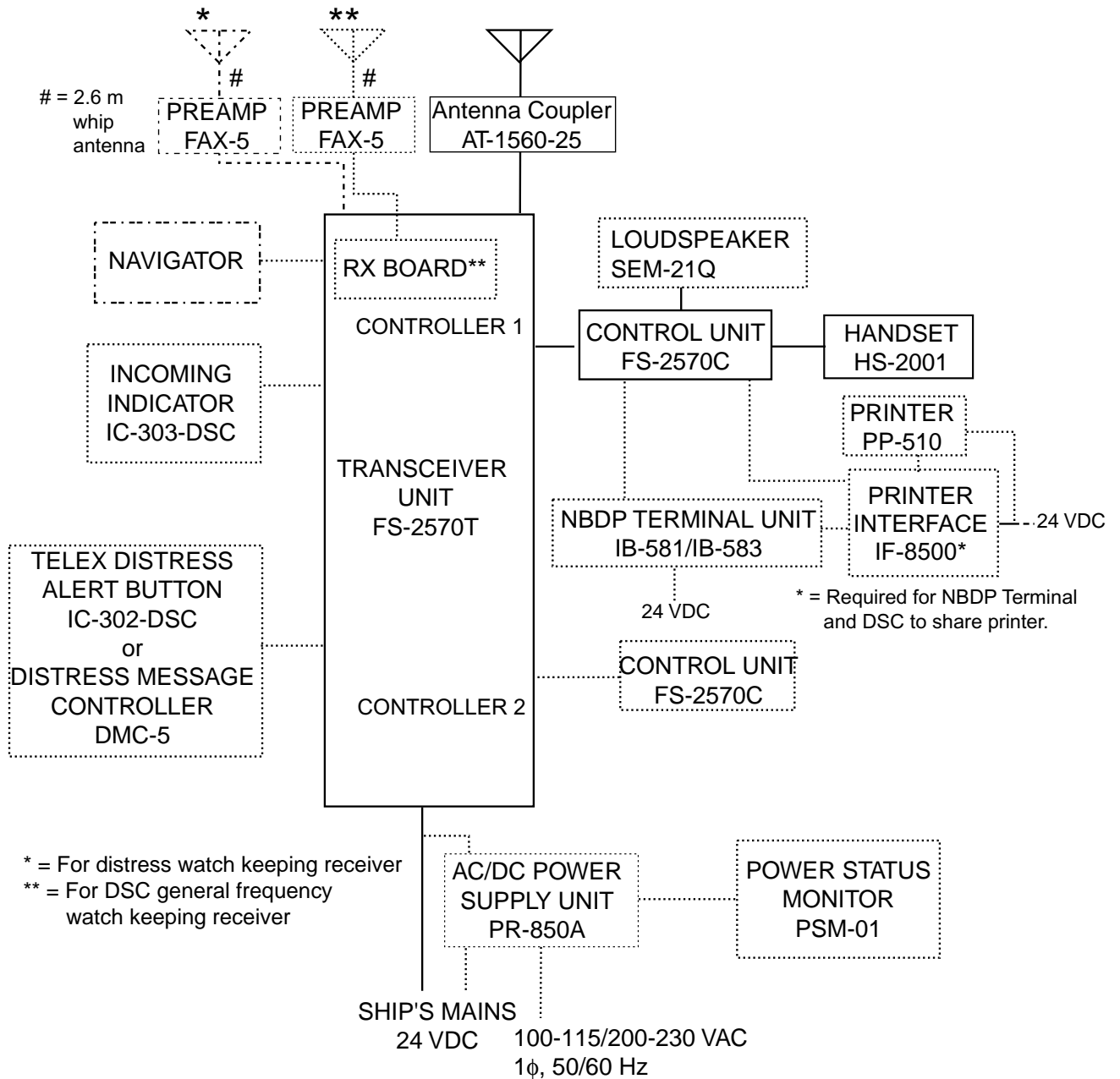

Unit	Category
Preamp Unit	Exposed to weather
Antenna Coupler	Exposed to weather
Other Units	Protected from weather

—— : STANDARD
 : OPTION
 - - - - : EXTERNAL EQUIPMENT

FS-1570 (150 W)

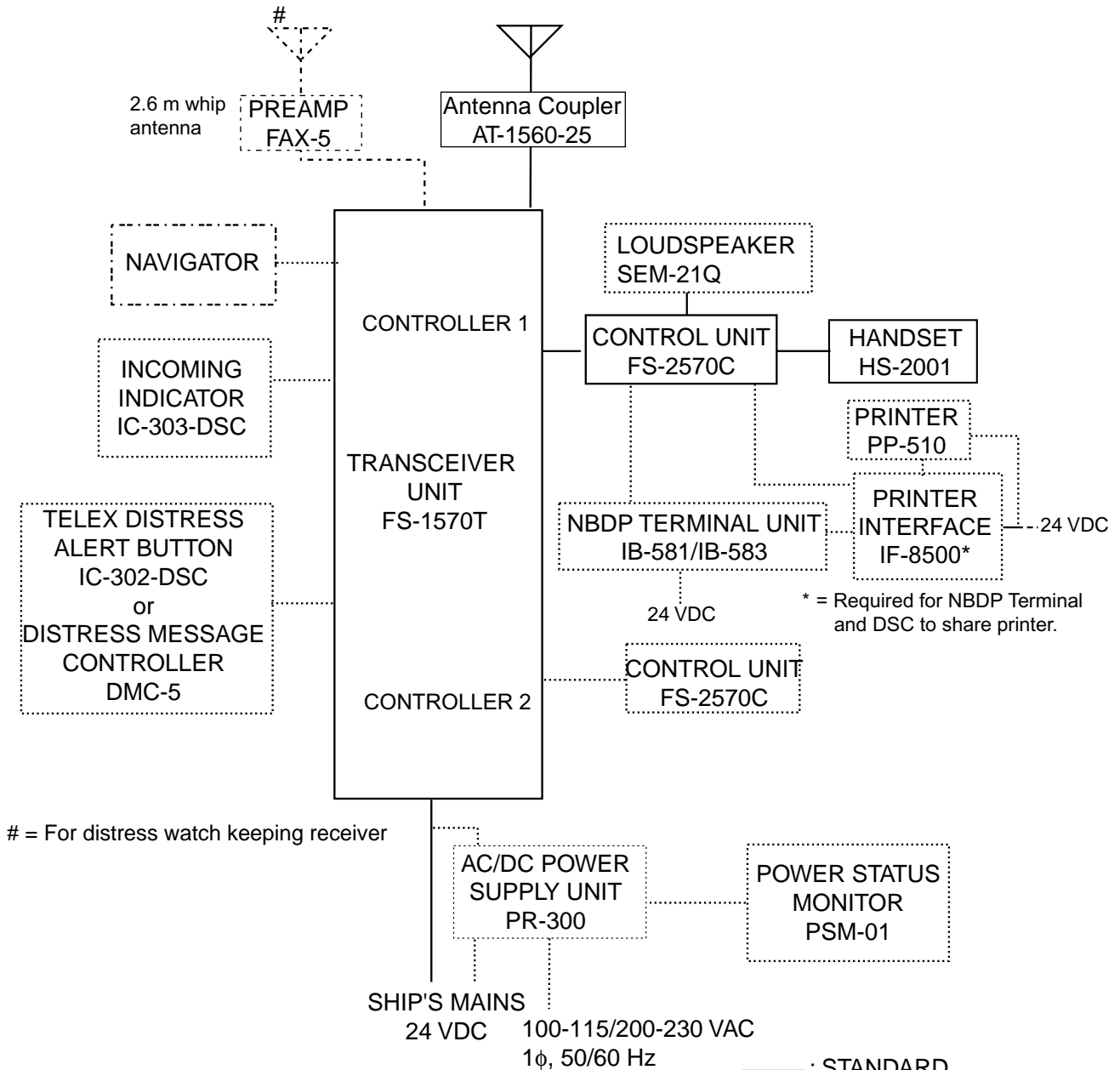

Unit	Category
Preamp Unit	Exposed to weather
Antenna Coupler	Exposed to weather
Other Units	Protected from weather

_____ : STANDARD
 : OPTION
 - - - - - : EXTERNAL EQUIPMENT

SPECIFICATIONS OF SSB RADIOTELEPHONE FS-1570/2570

1 MF/HF DIGITAL RADIOTELEPHONE

1.1 GENERAL

- 1.1.1 Communication System Semi-duplex or simplex
- 1.1.2 Class of Emission J3E: Telephone
 J2B (F1B): DSC or NBDP
 H3E: reception only
- 1.1.3 Frequency Range 100.00 kHz to 29,999.99 kHz
- 1.1.4 Number of Channel User programmable: 255 TX/RX pairs
 All ITU channels incorporated (include DSC/NBDP channels)
 2182 kHz (single action)
- 1.1.5 Display Method Monochrome LCD (120 x 64 dots)
- 1.1.6 Backlight 8 tones
- 1.1.7 Contrast 64 steps
- 1.1.8 Warming up 1 minute approx. (oven 20 minutes approx.)

1.2 TRANSMITTER

- 1.2.1 Frequency Range 1,606.5 kHz to 26.175 MHz (100 Hz steps)
- 1.2.2 RF output Power FS-1570: 150 Wpep, FS-2570: 250 Wpep
- 1.2.3 Frequency Resolution Within ± 10 Hz
- 1.2.4 Modulation AF Response 350 Hz to 2.7 kHz
- 1.2.5 Modulation System Low power balanced modulation
- 1.2.6 AF Input -46 dBm/600 ohms (Handset/Microphone)
 -10 dBm/600 ohms (Handset HS-2001)
- 1.2.7 Line in 0 dBm/600 ohms

1.3 RECEIVER

- 1.3.1 Receiving System Double-conversion superheterodyne
- 1.3.2 Frequency Range 100 kHz 29,999.9 kHz (10 Hz steps)
- 1.3.3 Sensitivity Input level at 10 ohms+250 pF (below 4 MHz) and 50 ohms
 (above 4MHz) to produce SINAD 20 dB

Frequency Range	J3E/H3E
100 kHz to 300 kHz	35 dB μ V
300 kHz to 1.6 MHz	25 dB μ V
1.6 MHz to 4.0 MHz	13 dB μ V
4.0 MHz to 30 MHz	7 dB μ V

- 1.4 Intermediate Frequency 1st: 72,455 kHz, 2nd: 455 kHz
- 1.5 Selectivity J3E: 2.4kHz at -6dB, H3E: 6kHz at -6dB
 J2B (F1B): 300Hz at -6dB
- 1.6 Inter-modulation Better than 80 dB μ V
- 1.7 Spurious Response Better than 70 dB
- 1.8 AGC SLOW/FAST/OFF
- 1.9 BFO Frequency Telex/DSC: 1,700 Hz, Facsimile: 1,900 Hz

- | | | |
|------|--------------------|--|
| 1.10 | Audio Output Power | Internal speaker: 1W/ 8 ohms
External speaker: 4W/ 4 ohms
Handset: 2.5mW/ 150 ohms
Line output: 0 dBm/ 600 ohms |
| 1.11 | Standard Features | Noise Blanker, Voice-activated squelch, Pre-selector |

2 DSC/WATCH KEEPING RECEIVER

2.1 DIGITAL SELECTIVE CALLING

- | | | |
|-------|-----------------------|---|
| 2.1.1 | Frequency Shift | Space: 1785.0 ± 0.5 Hz, Mark: 1615.0 ± 0.5 Hz |
| 2.1.2 | Baud Rate | 100 bps ± 30 x 10 ⁻⁶ |
| 2.1.3 | Protocol | Complies with ITU-R Rec.493-10, 541-8, 1082-1 |
| 2.1.4 | Modulation | AFSK |
| 2.1.5 | Distress Alarm | 3.5 s to 4.5 s self-repetition |
| 2.1.6 | Distress Alarm Memory | 50 messages |

2.2 DSC/WATCH RECEIVER

- | | | |
|--------|------------------------|---|
| 2.2.1 | Frequency Range | |
| | MF/HF specification | 2187.5/ 8414.5 and 4207.5/ 6312/12577/16804.5 kHz |
| | MF specification | 2187.5 kHz |
| 2.2.2 | Class of Emission | F1B, J2B |
| 2.2.3 | Antenna Impedance | 50 ohms |
| 2.2.4 | Local Oscillator | 1st: F+54,455 kHz, 2nd: 54,000 kHz, 3rd: 456.7 kHz |
| 2.2.5 | Frequency Stability | ±10 Hz |
| 2.2.6 | Intermediate Frequency | 1st: 54,455 kHz, 2nd: 455 kHz |
| 2.2.7 | Selectivity | -6 dB: 270 Hz to 300 Hz,
-30 dB: within ± 380 Hz,
-60 dB: within ± 550 Hz |
| 2.2.8 | Receiving System | Double-conversion superheterodyne |
| 2.2.9 | Radiation | within 2 nW |
| 2.2.10 | RX Error Rate | 1 % or less at 1 µV input voltage |
| 2.2.11 | Spurious Response | 31.6 mV non-modulated at 10µV input voltage,
at error rate within 1% |
| 2.2.12 | Scanning Reception | max. 6 frequencies within 2 s (MF/HF) |
| 2.2.13 | Diagnosis | Transmit high frequency signal of DSC |

2.3 GENERAL WATCH KEEPING RECEIVER (FS-2570 ONLY, OPTION)

- | | | |
|-------|------------------------|--|
| 2.3.1 | Frequency Range | 1,606.5 kHz to 27.5 MHz |
| 2.3.2 | Class of Emission | J2B, F1B |
| 2.3.3 | Antenna Impedance | 50 ohms |
| 2.3.4 | Local Oscillator | 1st: F+54,455 kHz, 2nd: 54,000 kHz, 3rd: 456.7 kHz |
| 2.3.5 | Frequency Stability | within ±10 Hz |
| 2.3.6 | Intermediate Frequency | 1st: 54,455 kHz, 2nd: 455 kHz |
| 2.3.7 | Selectivity | -6 dB: 270 Hz to 300 Hz,
-30 dB: within ± 380 Hz, |

	-60 dB: within ± 550 Hz
2.3.8 Receiving System	Double-conversion superheterodyne
2.3.9 Radiation	within 2 nW
2.3.10 RX Error Rate	1 % or less at 1 μ V input voltage
2.3.11 Spurious Response	31.6 mV non-modulated at 10 μ V input voltage, at error rate within 1%
2.3.12 Scanning Reception	max. 6 frequencies within 2 s (MF/HF)
2.3.13 Diagnosis	Transmit high frequency signal of DSC

3 NBDP FUNCTION (OPTION)

3.1 GENERAL

3.1.1 Communication Mode	ARQ, FEC, DIRC (FSK)
3.1.2 Protocol	ITU-R M625-3, M476-5, M490, M491-1, M492-6
ID code	4, 5, 9 column
Line cord	4B/3Y (Intl.)
Modulation	AFSK
Tone frequency	1615/1785Hz \pm 0.5 Hz (mark/space)
Tracking range	± 80 Hz
3.1.3 Applications	
Auto-reception	Setting timer and frequency (max. 10 settings available)
Frequency scanning	10 group max., 20 station as each group
User-channels	100 channels max.

4 TERMINAL UNIT

4.1 IB-583

4.1.1 Display	10.4" color TFT LCD, 640 x 480 dots
4.1.2 CPU	HD6417615 (15.5 MHz)
4.1.3 Memory	Flash ROM: 1 MB, S-RAM: 256 KB
4.1.4 FD Drive	1.44MB 3.5"
4.1.5 Keyboard	82 keys, IBM PS/2
4.1.6 Other functions	Text editor, FD control, Printer, Remote control for Transceiver, Diagnosis

4.2 IB-581

4.2.1 Display	9.5" monochrome LCD, 680 x 480 dots
4.2.2 CPU	ALI M6117 (33 MHz)
4.2.3 Memory	Flash ROM 2 MB, DRAM 2 MB
4.2.4 FD Drive	1.44MB 3.5"
4.2.5 Keyboard	82 keys, IBM PS/2

5 ANTENNA COUPLER

5.1 Tuning System	CPU controlled fully automatic tuning system
5.2 Frequency Range	1.6 MHz to 27.5Hz
5.3 Input Impedance	50 ohms
5.4 Antenna	7m to 30m wire or whip antenna

5.5	Power Capability	150 W (FS-1570), 250 W (FS-2570)
5.6	VSWR	1.5 max
5.7	Tuning Speed	Within 15 s
5.8	Dummy Load	FS-1570: 10 ohms + 250 pF/100W mounted in coupler FS-2570: 10 ohms + 250 pF/200W mounted in coupler

6 INTERFACE

6.1	Input data sentences	IEC 61162-1 (NMEA 0183-3)
	Ship's Position (L/L)	GGA>RMC>GLL
	Time	ZDA

7 POWER SUPPLY

7.1	Transceiver Unit/Control Unit	
	FS-1570	24 VDC: 0.8 A, max. 20 A (TX)
	FS-2570	24 VDC: 1.5 A, max. 35 A (TX)
7.2	Terminal Unit	IB-583: 24 VDC: 0.6 A IB-581: 24 VDC: 0.8 A
7.3	Printer	24 VDC: 1.5 A
7.4	AC/DC Power Supply Unit (option)	100/110/115/220/230VAC, 1 phase, 50/60 Hz

8 ENVIRONMENTAL CONDITION

8.1	Ambient Temperature	-15°C to +55°C
8.2	Relative Humidity	93 or less at 40°C
8.3	Water proofing (IEC 60529)	Control Unit (Panel): IPX2 Transceiver Unit/ Terminal Unit: IPX0 Antenna Coupler: IPX5
8.4	Vibration	IEC 60945

9 COATING COLOR

9.1	Control Unit/ Terminal Unit	Panel: N3.0, Cover: 2.5GY5/1.5
9.2	Transceiver Unit	2.5GY5/1.5
9.3	Antenna Coupler	N9.5 (white)

1 OPERATIONAL OVERVIEW

1.1 Controls

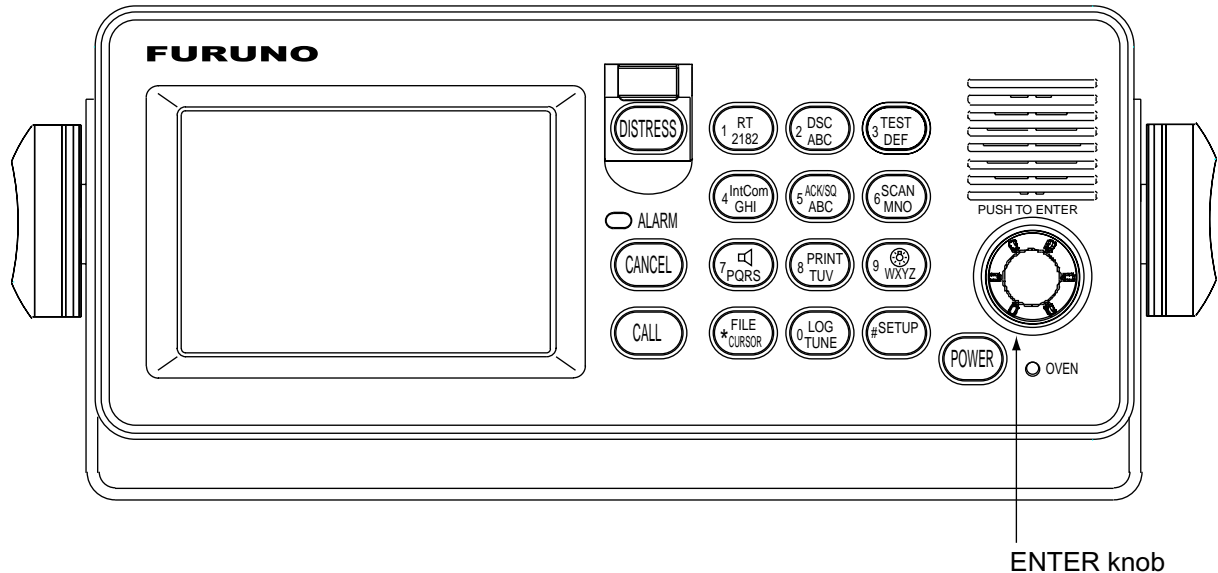

Description of controls

Control	Function
POWER switch	Turns the power on/off.
DISTRESS button	Press and hold down the button more than three seconds to transmit the distress alert.
CALL key	Transmits calls.
ENTER knob	Radiotelephone: Rotate to change TX/RX channel, sensitivity, audio volume, etc.; push to register selection. DSC: Rotate to choose menu items; push to register selection.
CANCEL key	<ul style="list-style-type: none"> • Cancels wrong data. • Restores previous menu. • Silences audio alarm. • Cancels transmission, printing. • Erases error message.
1/ RT/2182 key	Switches to the radiotelephone screen. Press and hold down more than two seconds to get 2182.0 kHz/J3E automatically.
2/DSC key	Composes DSC TX message.
3/TEST key	Executes daily test.
4/IntCom key	Turns on/off the intercom with other Control Unit FS-2570C.
5/ ACK/SQ key	DSC: Switches automatic and manual acknowledge alternately. Radiotelephone: Turns squelch on and off.
6/SCAN key	<ul style="list-style-type: none"> • Displays DSC standby screen. • Starts/stops scanning of DSC routine frequencies, on the DSC standby screen.

7/🔊 key	<ul style="list-style-type: none"> • Turns loudspeaker on/off. (Note that this key does not silence the distress or urgency alarm.)
8/PRINT key	Prints communications log files, current screen (except DSC standby screen and radiotelephone screen) and test results.
9/⊗ key	Adjusts panel dimmer and LCD contrast.
FILE/CURSOR key	<ul style="list-style-type: none"> • Opens the send message file list from the DSC standby screen, to send stored message. • Shifts cursor.
LOG/TUNE key	<ul style="list-style-type: none"> • Tunes antenna in radiotelephone operation. • Displays message logs, in DSC operation.
#/SETUP key	Opens the Setup menu.
ALARM lamp	<ul style="list-style-type: none"> • Flashes in red for distress and urgency calls. • Flashes in green (more rapidly) for business, safety and routine calls.
OVEN lamp	Lights (in green) when mains switchboard is on.

1.2 Turning the Power On/Off

Press the [POWER] switch at the right-hand side of the control unit to power the system. Press it again to turn the system off. In the dual control unit system, the control unit connected to the CONTROLLER 1 port on the transceiver unit has priority and it controls the power for both the No.1 and No. 2 control units. The power switch of the No. 2 control unit powers on/off the No. 2 control unit only.

Note: Turn on ship’s mains five minutes before turning on this equipment.

1.3 Panel Dimmer, LCD Contrast

1. Press the [9/⊗] key to show the dimmer/contrast adjustment window.

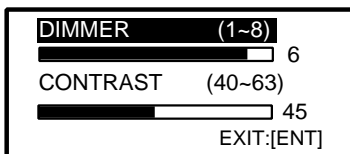

2. Rotate the [ENTER] knob to choose DIMMER or CONTRAST, whichever you want to adjust, and then push the [ENTER] knob.

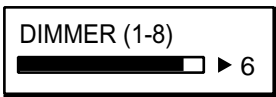

Dimmer adjustment window Contrast adjustment window

3. Rotate the [ENTER] knob to adjust and then push the [ENTER] knob.
4. To quit, rotate the [ENTER] knob to choose “EXIT: [ENT]” and then push the [ENTER] knob.

1.4 Indications

1.4.1 DSC standby screen

The DSC standby screen may be displayed by pressing the [6/SCAN] key.

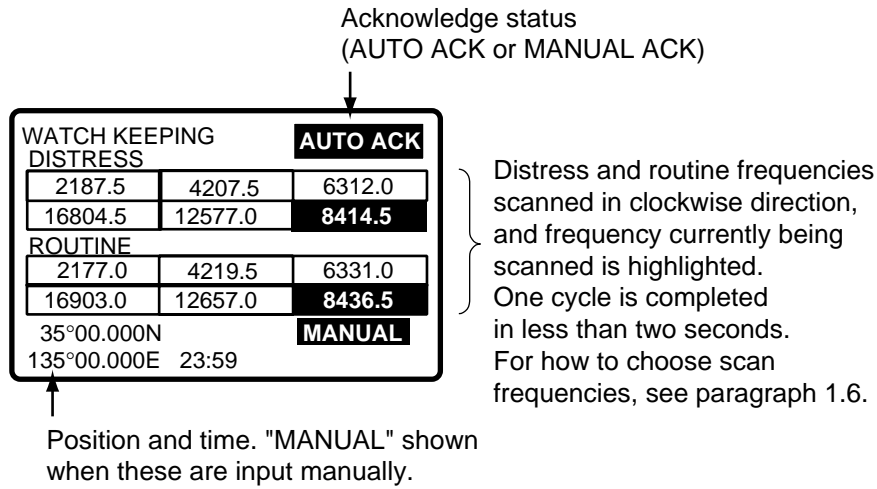

DSC standby screen

1.4.2 Radiotelephone screen

Press the [1/ RT/2182] key to show the radiotelephone screen. This is where you set up the radiotelephone.

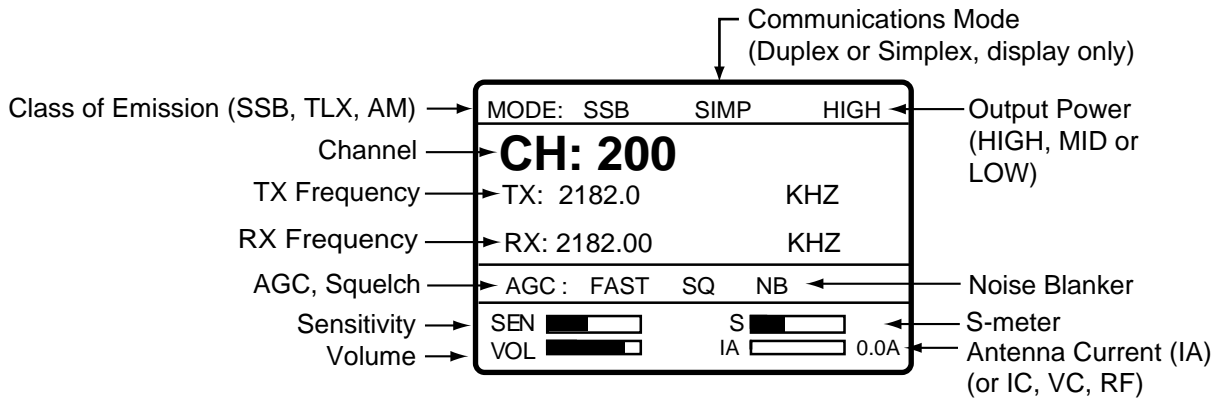

Radiotelephone screen

Note: "TX" is circumscribed with a rectangle when transmitting.

1.5 Loudspeaker

1. Press the [7/🔊] key to alternately disable or enable the loudspeaker and the alarm generated for routine messages. SOUND: ON or SOUND: OFF appears with each press.
2. To adjust loudspeaker volume do the following:
 - a) Press the [1/RT 2182] key to show the radiotelephone screen.
 - b) Rotate the [ENTER] knob to choose VOL at the bottom of the screen and then push the [ENTER] knob.
 - c) Rotate the [ENTER] knob to adjust volume and then push the [ENTER] knob.



1.6 Scanning Routine DSC Frequencies

You can scan frequencies when using the DSC mode. For how to set frequencies, see paragraph 7.4. Radiotelephone and telex are inoperative while scanning. However, in case of the FS-2570, those modes may be used during scanning when the optional internal watch keeping receiver is installed.

1. Press the [6/SCAN] key to show the DSC standby screen.
2. Press the [6/SCAN] key to start/stop scanning.

1.7 Automatic Acknowledge On/Off

The automatic acknowledge feature of the DSC/watch receiver automatically transmits the acknowledge back (ACK BQ) signal to the sending station when an individual, position or polling call is received. (For position and polling calls, respective item on the AUTO ACK menu must be turned on to enable automatic acknowledge.) Automatic acknowledge can be turned on or off at the DSC standby screen by the [5/ACK/SQ] key. The message ACK: AUTO or ACK: MANUAL appears at the bottom of the DSC standby screen with each press of the key.

Note 1: To give priority to own ship's communications while own ship is communicating, show ACK: MANUAL by the above procedure.

Note 2: Automatic acknowledge is not possible under the following conditions:

- Priority: Distress, Urgency or Safety
- Com Type: Morse, Fax, Data, No Info
- Com Freq: No Info
- Off Hook

1.8 Manual Entry of Position and Time

If there is no EPFS (Electronic Position-Fixing System) connected to this equipment or the EPFS connected is not working (EPFS error indication appears), manually enter position and time as follows:

1. At the DSC standby screen, press the [# / SETUP] key to display the Setup menu.

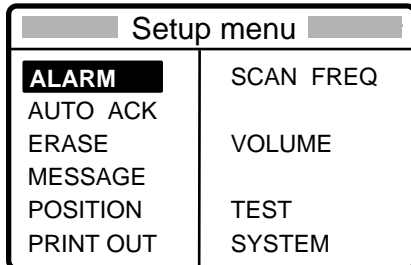

2. Rotate the [ENTER] knob to choose POSITION and then push the [ENTER] knob.

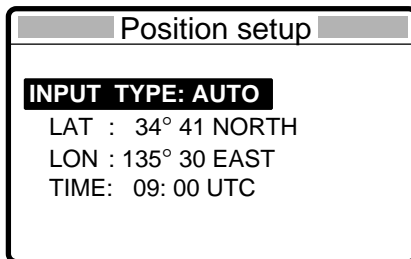

3. Push the [ENTER] knob to open the INPUT TYPE menu.

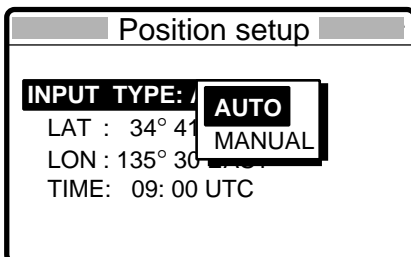

Note 1: If, when INPUT TYPE is AUTO, input from the navigator is interrupted, the message “EPFS error!” appears. If this occurs, check the navigator.

Note 2: When INPUT TYPE is MANUAL, the message “Warning: Update position” appears at set intervals (update interval selected with POSITION OLDER on the Alarm menu) to ask you to update position.

4. Rotate the [ENTER] knob to choose MANUAL and then push the [ENTER] knob.

1 OPERATIONAL OVERVIEW

5. Push the [ENTER] knob to open the latitude input window. Use the numeric keys to enter latitude. If necessary, switch coordinates: [1] key to switch to North; [2] key to switch to South. Push the [ENTER] knob.

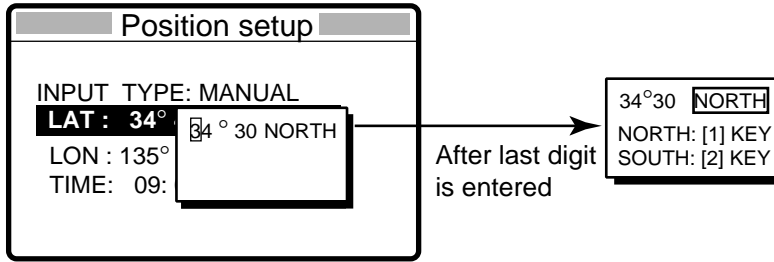

6. Push the [ENTER] knob to open the longitude input window. Use the numeric keys to enter longitude. If necessary, switch coordinates: [1] key to switch to East; [2] key to switch to West. Push the [ENTER] knob.

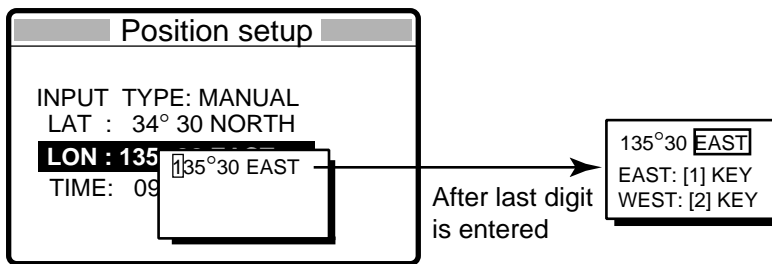

7. Push the [ENTER] knob to open the time input window.

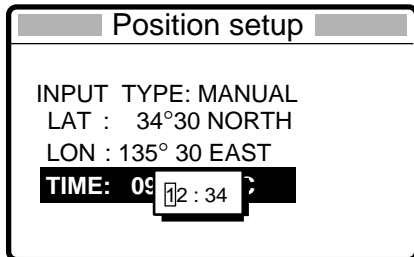

8. Enter UTC time with the numeric keys and then push the [ENTER] knob. The Setup menu appears.
9. Press the [CANCEL] key to return to the DSC standby screen.

1.9 System Characteristics

1.9.1 Equipment priority

Equipment priority order is as below.

1. DMC
2. Control unit sending distress alert
3. Control unit 1 – routine use
4. Control unit 2 – routine use
5. NBDP

1.9.2 Controls become inoperative

Controls become inoperative in the following conditions:

- Controls of idle control unit in the two-control unit system when other control unit goes OFF HOOK.
- Controls of idle control unit in the two-control unit system when other control unit switches to the DSC mode.
- Distress received by DMC (Distress Message Controller).
- NBDP is scanning or communicating.
- Distress alert or distress relay is transmitted.
- Call other than distress is transmitted (transmission time about 8 s). If it becomes necessary to unlock the keyboard before the message is transmitted, press the [CANCEL] key to cancel the call.

1.9.3 Controls become operative

Controls become operative in the following conditions:

- [DISTRESS] button is pressed.
- Control unit having highest priority is operated.
- Other control unit in two-control unit system goes ON HOOK.
- Distress received by DMC is acknowledged.
- NBDP stops scanning or communicating.

1.9.4 Automatic setting of working frequency

The radiotelephone automatically sets working frequency in the following conditions:

- ABLE ACK is sent in response to individual call.
- Your ship receives ABLE ACK in response to own ship-initiated individual call.
- Your ship sends all ship call.
- Your ship sends distress relay.
- Your ship sends distress alert.
- Your ship receives group call or area call.
- Your ship receives distress relay call.
- Your ship receives distress alert.

1.10 Power Supply Unit (option)

The control unit works directly on 24 VDC or through a Power Supply Unit on AC mains supply (115 or 230 VAC). The power supply unit is type PR-300, supplying 24 VDC power (20 A) to the FS-1570 or type PR-850A, supplying 24 VDC (40 A) to the FS-2570. Both 115/230 VAC and 24 VDC power can be connected simultaneously. In this case, the system normally operates on the AC mains supply and when AC power is lost, the PSU automatically switches to the DC power source.

This power supply arrangement satisfies the GMDSS requirements. The FS-1570/FS-2570 can be operated directly from 24 VDC without a power supply.

OVEN power supply: The crystal oven is always powered even when the Power Switch is OFF, provided the mains switchboard is turned on.

AC and DC power switches

Both AC and DC power switches on the PSU can be always kept on. (These switches are provided to turn off the power supply for maintenance.) The control unit may be turned on or off with the PSU kept on.

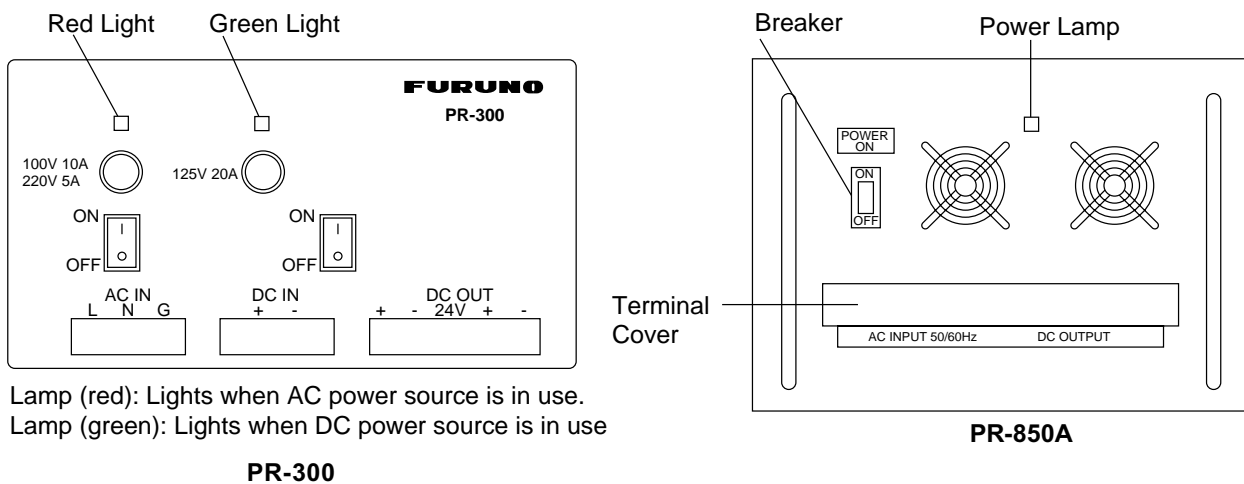

Power supply units

Note: Both lamps light when changing to DC power supply (PR-300). These lamps also light when the internal temperature goes too high.

2 SSB RADIOTELEPHONE

You can enter desired frequency by channel or TX and RX frequencies. The handset may be ON HOOK or OFF HOOK. To set the SSB radiotelephone to 2182 kHz/J3E automatically, press the [1/ RT/2182] key more than two seconds.

2.1 Transmitting

After selecting class of emission and frequency, you can transmit by pressing the PTT switch on the handset. Output power is shown on the display.

2.1.1 Choosing class of emission

1. At the radiotelephone screen, choose class of emission (mode) as follows:

Rotate the [ENTER] knob to choose MODE and then push the [ENTER] knob.

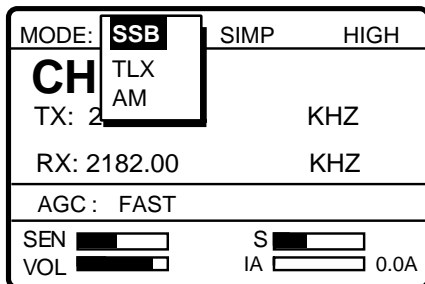

Rotate the [ENTER] knob to choose mode desired and then push the [ENTER] knob. SSB: Single Sideband, TLX: Telex, AM: AM. (You cannot transmit on the AM mode.)

2. AGC is automatically selected according to mode. AGC FAST: SSB, AGC OFF: TLX, AGC SLOW: AM. However, you may change it as below.

- a) Rotate the [ENTER] knob to choose AGC and then push the [ENTER] knob.

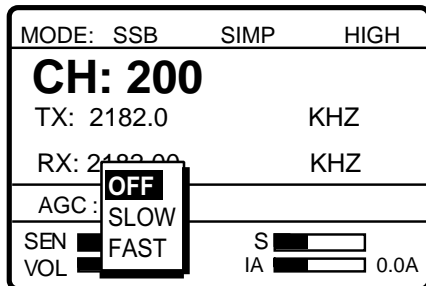

- b) Rotate the [ENTER] knob to choose OFF, SLOW or FAST as appropriate and then push the [ENTER] knob.

2.1.2 Choosing channel, frequency

Choosing channel

1. Rotate the [ENTER] knob to choose CH and then push the [ENTER] knob.

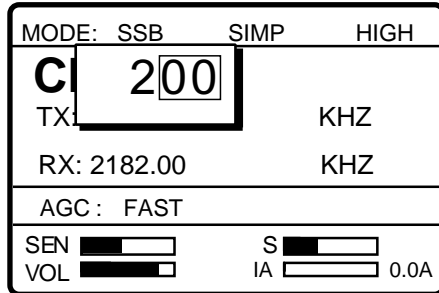

2. Channel can be entered directly with the numeric keys, or by using the [ENTER] knob. See below for details.

Entering band and band channel with the numeric keys: Use the numeric keys to enter band and band channel and then push the [ENTER] knob.

Choosing band and band channel with the ENTER knob:

- a) Use the [FILE/CURSOR] key to place the cursor in the band or band channel position, whichever you want to change.



Cursor position for selection of band channel



Cursor position for selection of band

- b) Rotate the [ENTER] knob to set band (or channel) desired.

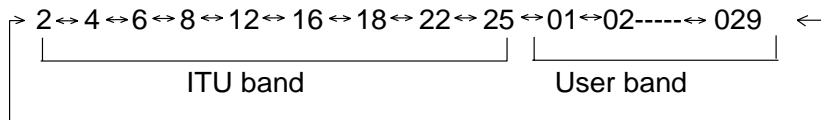

Setting Range

- ITU Band: 2/4/6/8/12/16/18/22/25
- User Band: 001-029 (leading zero necessary)
- ITU Channel: XX01 - XX236 (rendering on band or mode)
- User Channel: XXX01 - XXX99

- c) Push the [ENTER] knob. The TX and RX frequencies of the channel entered appear.

Choosing frequency

1. Rotate the [ENTER] knob to choose TX or RX as appropriate and then push the [ENTER] knob.

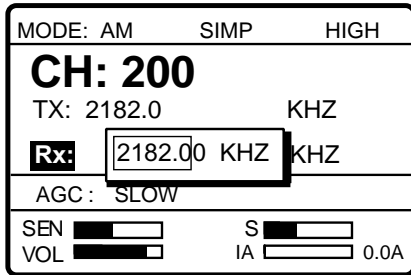

2. Enter frequency by one of the methods below.

Entering frequency with the numeric keys:

Use the numeric keys to enter frequency and then push the [ENTER] knob. Be sure to include trailing zero. For example, to enter 2161 kHz, key in [2], [1], [6], [1], [0]. (Keying in 2-1-6-1 will set 216.1 kHz.)

Choosing frequency with the ENTER knob (for RX only):

- a) Use the [FILE/CURSOR] key to choose digit to change.
- b) Rotate the [ENTER] knob to set digit.
- c) Push the [ENTER] knob.

Note: To enter same frequency for both TX and RX, enter the TX frequency first.

2.1.3 Tuning

Maximum transmission power is achieved only when the antenna impedance and transmitter impedance match each other. Because the antenna impedance changes with frequency, a means must be provided to match (tune) the antenna impedance with the transmitter impedance. This is done with the antenna coupler. The antenna coupler automatically tunes the transmitter to a wide range of different antenna lengths, from 7 to 30 m.

To initiate the automatic tuning, do the following:

1. Press the PTT switch on the handset or the [LOG/TUNE] key on the control unit. "TUNING" appears when the [LOG/TUNE] key is pressed; "TX" pops out when the PTT switch is pressed.

Tuning will be completed within 2 to 5 s for a newly selected frequency, or less than 0.5 s for a once-tuned frequency. (A memory saves coil and capacitor settings.) When the tuning process is successfully completed, TUNE: OK appears. If tuning fails, TUNE: NG appears.

Note: When tuning is initiated in the two-control unit system, the display of the idle control unit shows “OCCUPIED(ANOTHER CONTROLLER).” In this case, only the DISTRESS button is operative on the idle control unit. Further, if a control unit is in use when tuning is attempted at the other control unit, the display of the control unit which attempted to tune shows “OCCUPIED” plus the name of the equipment in use: ANOTHER CONTROLLER, NBBDP, or DMC.

2.1.4 Using the handset

Hold the handset close to your mouth, press the PTT switch and speak clearly.

2.1.5 Monitoring transceiver output power

During transmission, the IA bar deflects according to the current being fed to the antenna feeder from the antenna coupler. The unit of readout is amperes. The antenna current varies with the effective antenna impedance. The swing differs by the frequency and antenna length. The output power is proportional to the square of an antenna current.

Note: If IA is not shown, follow the procedure in paragraph 2.1.7 to show it.

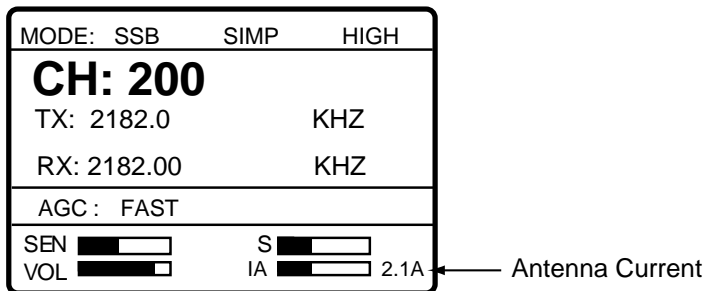

2.1.6 Reducing transmitter power

To conserve energy and to minimize possible interference to other stations, reduce the transmission power. This should be done when using the transceiver in a harbor, near the shore or close to communication partner (other ship).

1. Rotate the [ENTER] knob to choose LOW, MID or HIGH (whichever is shown) at the top of the screen and then push the [ENTER] knob.

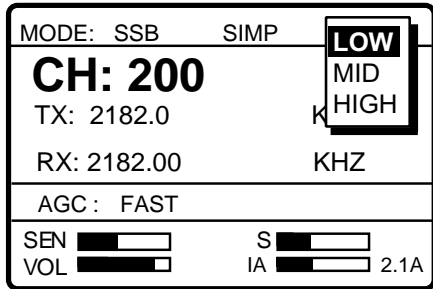

	FS-1570	FS-2570
LOW	68 W	70 W
MID	100 W	125 W
HIGH	150 W	250 W

2. Rotate the [ENTER] knob to choose power among LOW, MID and HIGH as appropriate and then push the [ENTER] knob.

Note: Power amplifier temperature is monitored, and when its temperature rises above a certain temperature output power is automatically reduced.

2.1.7 Displaying IA, IC, VC or RF

While transmitting, you may display RF (PA output), IA (antenna current), IC (collector current) or VC (collector voltage), at the lower right corner of the radiotelephone screen.

1. Rotate the [ENTER] knob to choose RF, IA, IC or VC (whichever is displayed) at the bottom right corner.
2. Push the [ENTER] knob.

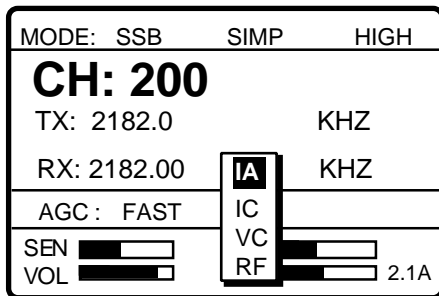

3. Rotate the [ENTER] knob to choose option desired and then push the [ENTER] knob.

2.2 Receiving

2.2.1 RF gain (sensitivity) adjustment

In normal use the sensitivity should be set for maximum. If the audio on the received channel is unclear or interfered with other signals, adjust (usually reduce) sensitivity to improve clarity.

1. Rotate the [ENTER] knob to choose SEN at the bottom of the screen and then push the [ENTER] knob.

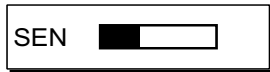

2. Rotate the [ENTER] to adjust and then push the [ENTER] knob.

2.2.2 S-meter

The S-meter shows relative signal strength coming into the receiver frontend. Note that the S-meter does not function when the AGC is turned off.

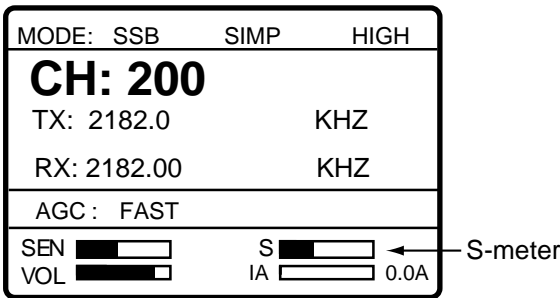

2.2.3 Monitoring traffic on intended transmit frequency

When a semi-duplex channel is selected, it is recommended to monitor if there is no existing traffic on the frequency you are going to use. This can be done by entering the Tx frequency at the Rx frequency location.

2.2.4 Receiving AM broadcasting stations

1. Press the [1/ RT/2182] key to show the radiotelephone screen.
2. Rotate the [ENTER] knob to choose MODE and then push the [ENTER] knob.

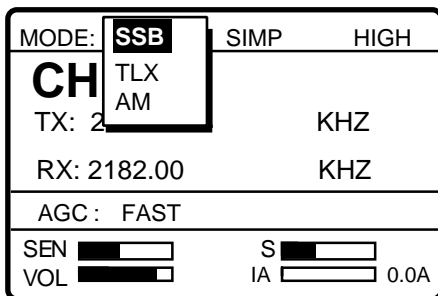

3. Rotate the [ENTER] knob to choose AM and then push the [ENTER] knob.
4. Rotate the [ENTER] knob to choose RX and then push the [ENTER] knob.

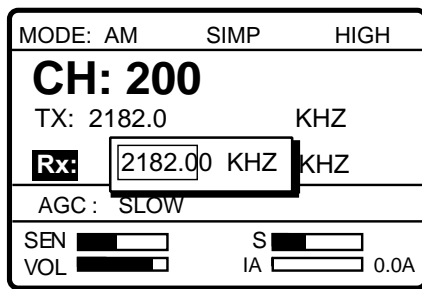

5. Key in RX frequency with the numeric keys and then push the [ENTER] knob.

2.2.5 Squelch control, squelch frequency

Squelch on/off

The squelch mutes the audio output in the absence of an incoming signal. Press the [5/ACK/SQ key] to turn on and off the squelch alternately. When radio noise is too jarring during stand-by condition, it may be muted by activating the squelch. "SQ" appears when the squelch function is active.

Squelch frequency

1. At the radiotelephone screen, press the [#/SETUP] key.

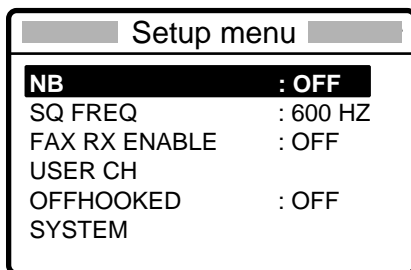

2. Rotate the [ENTER] knob to choose SQ FREQ.
3. Push the [ENTER] knob.
4. Enter frequency (range: 500-2000 Hz, default 800 Hz) with the numeric keys and then push the [ENTER] knob.
5. Press the [CANCEL] key to return to the radiotelephone screen.

2.2.6 Noise blanker

The noise blanker functions to remove noise. You may turn it on or off as follows:

1. At the radiotelephone screen, press the [#/SETUP] key.
2. Rotate the [ENTER] knob to choose NB.
3. Push the [ENTER] knob.
4. Rotate the [ENTER] knob to choose ON or OFF as appropriate and then push the [ENTER] knob.
5. Press the [CANCEL] key to return to the radiotelephone screen.

2.3 Intercom

The built-in intercom permits voice communications between two FS-2570C Control Units.

1. Press the [1/ RT/2182] key to show the radiotelephone screen.
2. Off hook the handset.
3. Press the [4/IntCom] key to show INTERCOM on the display. The called party's handset rings.
4. When the called party picks up their handset, start communications.
5. Hang up the handset to turn the intercom off. The indication INTERCOM disappears from the screen.

2.4 Telex Communications

Telex communication is performed with the NBDP Terminal Unit (option) connected to this radiotelephone. No special operation is required on the control unit; class of emission and frequencies are set on the NBDP Terminal Unit. For telex communications, see Chapters 8 through 11.

2.5 When Automatic Tuning Fails

The antenna coupler automatically tunes a wire or whip antenna to the transceiver. When all frequencies cannot be tuned, TUNE OK will not appear on the display. In this case, you can tune 2182 kHz by manually operating the coupler as shown in the procedure below.



1. Turn off the control unit. Remove the cover of the antenna coupler.
2. Set the MANUAL-AUTO switch to the MANUAL position.

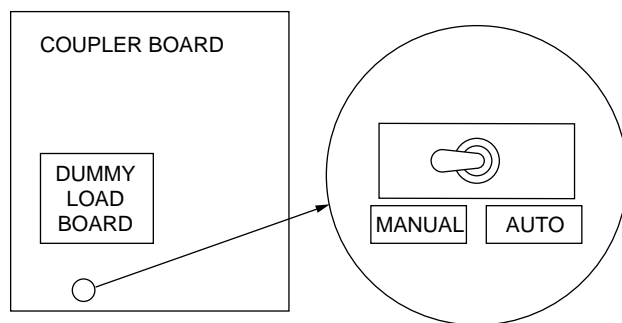

3. Replace the cover.
4. Turn on the control unit.

2.6 User Channels

The USER CH menu allows registration of user TX and RX channels, where permitted by the Authorities.

NOTICE
FURUNO will assume no responsibility for the disturbance caused by the unlawful or improper setting of user channels.

2.6.1 Registering user channels

“USER CH” in the System setup menu must be enabled in order to register user channels. For further details, contact your dealer.

1. At the radiotelephone screen, press the [#/SETUP] key.

Setup menu	
NB	: OFF
SQ FREQ	: 600 HZ
FAX RX ENABLE	: OFF
USER CH	
OFFHOOKED	: OFF
SYSTEM	

2. Rotate the [ENTER] knob to choose USER CH and then push the [ENTER] knob. The window shown below appears.

ENTRY
ERASE

3. ENTRY is selected; push the [ENTER] knob.

User ch entry	
◀ MODE: SSB	▶ CH: 2-01
00201. TX: 2111.5 RX: 2111.5	
00202. TX: 2222.0 RX: 2222.0	
00203. TX: 2333.5 RX: 2333.5	
00204. TX: 2444.0 RX: 2444.0	
00205. TX: 2555.5 RX: 2555.5	
▲ UP ▼ DOWN	

4. Push the [ENTER] knob to open the user channel options window.

User ch entry	
◀ MODE: SSB	▶ CH: 2-01
00201. TX: 2111.5 RX: 2111.5	
00202. MODE RX: 2222.0	
00203. CH RX: 2333.5	
00204. FREQ RX: 2444.0	
00205. TX: 2555.5 RX: 2555.5	
▲ UP ▼ DOWN	

5. Rotate the [ENTER] knob to choose MODE and then push the [ENTER] knob.

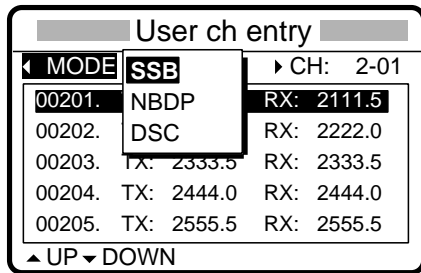

6. Rotate the [ENTER] knob to choose appropriate mode among SSB, NBDP and DSC and then push the [ENTER] knob.

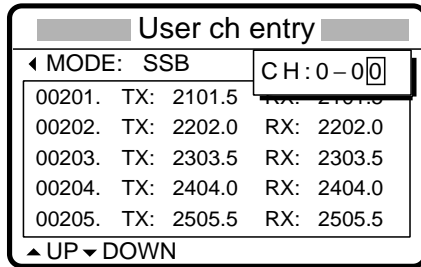

- 256 channels may be registered.
- Band no. setting range is 0-29 and band channel no. range is 01-99.
- For DSC, four channels can be registered per band (2, 4, 6, 8, 12, 16, 18, 22, 25).
- "0" band is for DSC frequencies only, and they are registered under "OTHER." Four channels are available, 01-04.

7. Key in channel no. and then push the [ENTER] knob. For example, press [0], [1], [2], [3], [4] and then push the [ENTER] knob to enter channel 01234.

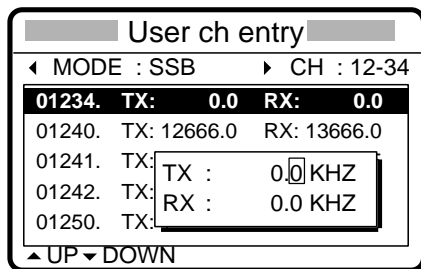

8. Enter TX frequency with the numeric keys.
9. Rotate the [ENTER] knob to choose RX.
10. Enter RX frequency with the numeric keys and then push the [ENTER] knob.
11. Rotate the [ENTER] knob to display all channels entered.
12. Press the [CANCEL] key twice to return to the radiotelephone screen.

2.6.2 Deleting user channels

Deleting individual user channels

1. At the radiotelephone screen, press the [#/SETUP] key.
2. Rotate the [ENTER] knob to choose USER CH and then push the [ENTER] knob.
3. Rotate the [ENTER] knob to choose ENTRY and then push the [ENTER] knob.
4. Push the [ENTER] knob, rotate the [ENTER] knob to choose CH and then push the [ENTER] knob.
5. Enter channel number to process and then push the [ENTER] knob.
6. Tx and Rx frequencies are shown as "0.0 kHz"; push the [ENTER] knob to delete channel.
7. Press the [CANCEL] key twice to return to the radiotelephone screen.

Deleting all user channels

1. At the radiotelephone screen, press the [#/SETUP] key.
2. Rotate the [ENTER] knob to choose USER CH and then push the [ENTER] knob.
3. Rotate the [ENTER] knob to choose ERASE and then push the [ENTER] knob.
4. Rotate the [ENTER] knob to choose YES and then push the [ENTER] knob.
5. Press the [CANCEL] key to return to the radiotelephone screen.

2.7 FAX Enable/Disable

You may enable or disable FAX use as follows:

1. At the radiotelephone screen, press the [#/SETUP] key to open the Setup menu.
2. Rotate the [ENTER] knob to choose FAX RX ENABLE and then push the [ENTER] knob.
3. Rotate the [ENTER] knob to choose ON or OFF as appropriate and then push the [ENTER] key.

MODE: SSB	SIMP	HIGH
CH	TLX	
TX: 2	FAX	
	AM	
RX: 2182.00		KHZ
		KHZ
AGC: FAST		
SEN <input type="checkbox"/>	S <input type="checkbox"/>	
VOL <input type="checkbox"/>	IA <input type="checkbox"/>	0.0A

4. Press the [CANCEL] key to close the menu.

2.8 Speaker Setting in Off Hook

When the handset is off hook, you may choose to turn the speaker (panel speaker or external speaker) on or off. The default setting is OFF which turns off the speaker when the handset is off hook. The ON position keeps the speaker on always, regardless of handset state.

1. At the radiotelephone screen, press the [*/SETUP] key to display the SETUP menu.

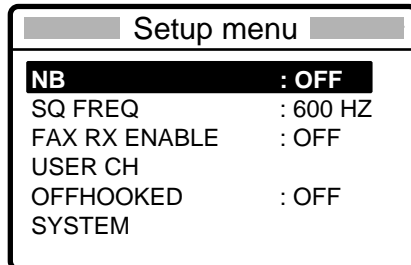

2. Rotate the [ENTER] knob to choose OFFHOOKED and then push the [ENTER] knob.
3. Rotate the [ENTER] knob to choose ON or OFF as appropriate and then push the [ENTER] key.
4. Press the [CANCEL] key to close the menu.

(This page intentionally left blank.)

3 DSC OVERVIEW

3.1 What is DSC?

DSC is an acronym meaning Digital Selective Calling. It is a digital distress and general calling system in the MF and HF bands used by ships for transmitting distress alerts and general calls and by coast stations for transmitting the associated acknowledgements. For DSC distress and safety calling in the MF and HF bands, the frequencies are (kHz) 2187.5, 4207.5, 6312.0, 8414.5, 12577.0, and 16804.5.

The DSC station sends and receives DSC general and safety calls via the radiotelephone.

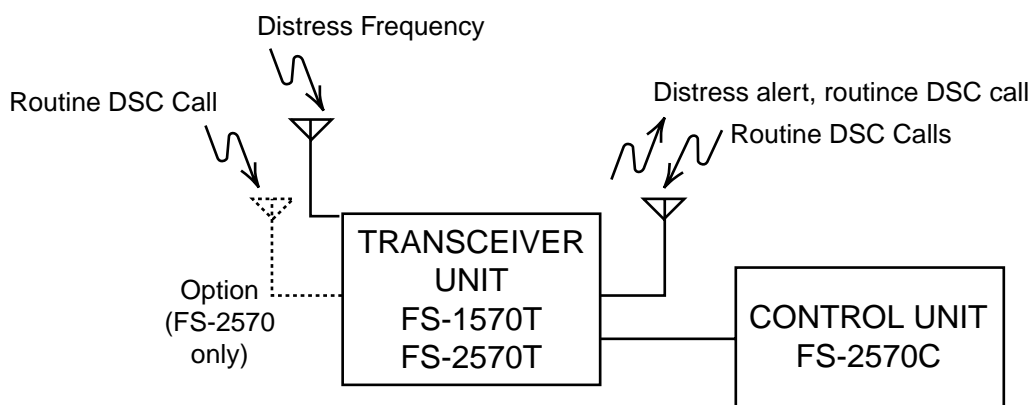

3.2 DSC Call

DSC calls are roughly divided in two categories: distress and safety calls, and routine calls. Below are the types of DSC calls.

Call	Description
All Ships	Call to all ships
Distress	Your ship sends distress call
Distress relay all	Your ship relays distress call to all ships
Distress relay select	Your ship relays distress call to a coast station
Geographical Area	Call to all ships in a specific geographical area
Group	Call to a specific group
Individual	Call to a specific address
Medical Transport	Inform all ships that your ship is carrying medical supplies
Neutral Craft	Inform all ships that your ship is not a participant in armed conflict
Polling	Call to determine if own ship is in communicating range with other ship
Position	1) You send your position to other stations 2) Your ship requests position of other station
PSTN	Call over Public Switched Telephone Network (PSTN)
Test	Send test signal to a coast station to test your station's functionality

Contents of a DSC call

- **Calling category**

Call category	Call
Individual	Individual, PSTN, Test, Position, Polling, Relay Sel (specific coast station)
All Ships	All Ships, Neutral, Medical, Relay All
Group	Group
Geographical Area	Area
Distress Call	Distress

- **Station ID**

Own ship ID and sending station ID. Coast station ID begins with 00; Group ID begins with 0.

- **Priority**

Distress: Grave and imminent danger and request immediate assistance.

Safety: A station is about to transmit a call containing an important navigational or meteorological warning.

Urgency: A calling station has a very urgent call to transmit concerning safety of ship, aircraft or other vehicle or safety of person.

Business: Communication related to the navigation, movements and needs of ships and aircraft.

Routine: General calling

- **Communication type**

Telephone: Telephone (J3E) by SSB radiotelephone

NBDP-ARQ: Telex (J2B) mode ARQ via NBDP Terminal Unit

NBDP-FEC: Telex (J2B) mode FEC via NBDP Terminal Unit

- **Communication frequency**

Working frequency used to call by telephone or NBDP. The sending station may have the receiving frequency (ship or coast station) assign the frequency to use.

- **Position**

Position can be automatically or manually sent.

- **DSC frequency**

DSC frequency to use. If the call category is SAFETY, URGENCY or DISTRESS, choose a DSC distress frequency.

- **End code**

The end of a DSC call is denoted by ACK RQ (Acknowledge Request), ACK BQ (Acknowledge Back) or EOS (End of Sequence).

3.2.1 Distress alert call and reply

This type of call is sent by own ship in the event of distress, by using the [DISTRESS] button as follows:

1. The LED in the [DISTRESS] button initially flashes, and lights when the button is pressed more than three seconds. (If the button is pressed less than three seconds, the distress alert is not sent. Once the alert is sent it cannot be cancelled.)

NOTICE
<p>IN CASE OF ACCIDENTAL TRANSMISSION OF THE DISTRESS ALERT</p> <p>If the distress is accidentally transmitted, contact the nearest coast station and inform them of the accidental transmission as follows:</p> <p>a) Ship's name b) Ship's call sign and DSC number c) Position at time of transmission d) Time of transmission</p>

2. The radiotelephone automatically sets the DSC distress frequency and then the equipment transmits the distress alert.
3. After the distress alert is transmitted (this takes about 40 seconds), the equipment waits for the distress acknowledgement call (DIST ACK) from a coast station. This usually takes less than three minutes. (If it is not received within 4.5 minutes, the distress alert is re-transmitted.)
4. The radiotelephone automatically sets the distress communication frequency to use to conduct voice communications (telex also available) with the coast station.

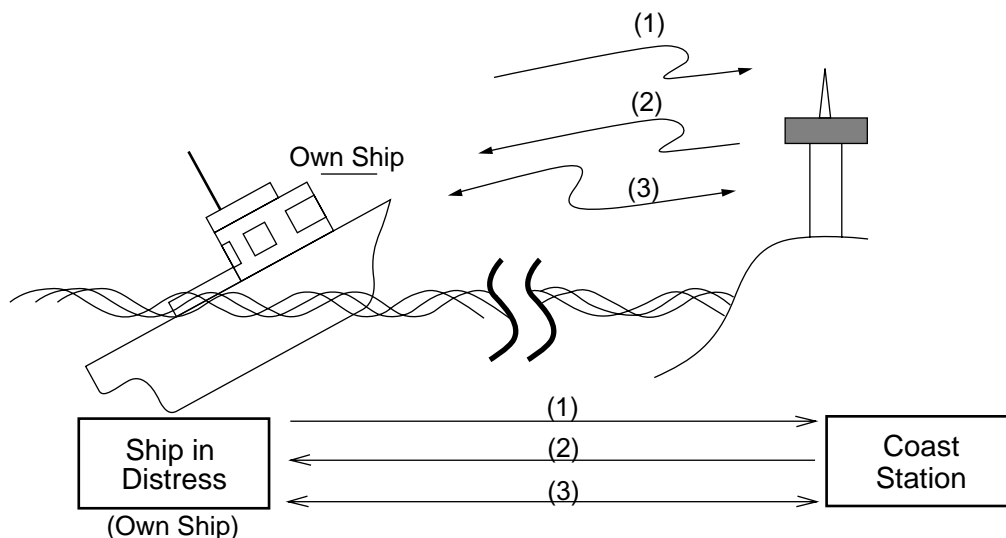

- (1) Ship in distress sends Distress Alert.
- (2) Coast station sends distress acknowledgement (DIST ACK).
- (3) Voice or telex communications between ship in distress and coast station

3.2.2 Individual call

The individual call is for sending a call to a specific station.

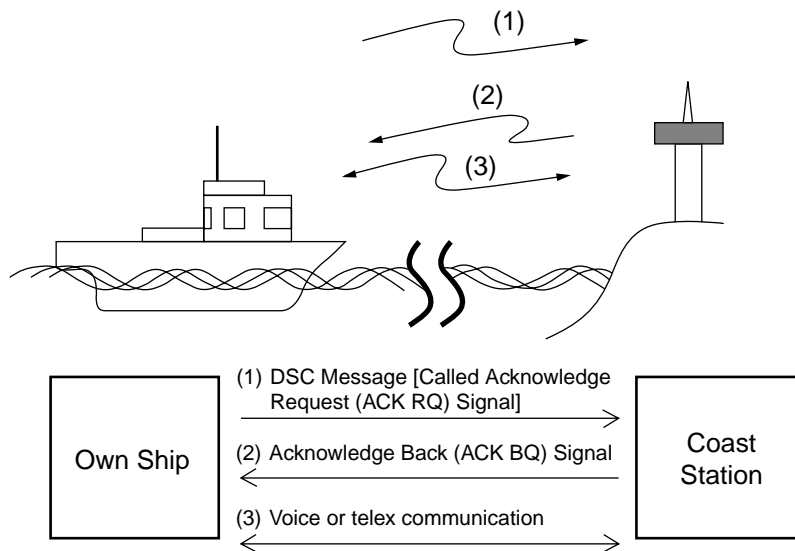

Basic procedure (radiotelephone)

1. Prepare call and transmit it by pressing the [CALL] key. The equipment then awaits acknowledgement of the call.
2. Receive acknowledge back (ACK BQ) signal from other party (coast station or ship station) within about five minutes. The audio alarm sounds at this time; press the [CANCEL] key to silence it.
3. After receiving the ACK BQ signal, communicate with other party; the radiotelephone automatically sets the working frequency and class of emission you specified.

3.3 Audio Alarms

When you receive a distress alert or routine call addressed to your ship, the audio and visual alarms are released. For the distress or urgency call, the audio alarm sounds until the [CANCEL] key is pressed, and sounds for one second and then automatically goes off in case of other calls. The tone of the alarm changes with the call received. By becoming accustomed to the tone, you can know which type of call you have received.

Alarm	Frequency (interval)
Safety call received	1300 Hz and 0 Hz (250 ms)
Routine, Ship's Business call received	880 Hz and 440 Hz (500 ms)
While DISTRESS button is pressed for three s	2200 Hz and 0 Hz (125 ms)
Distress alert sent	2200 Hz, continuous
Own ship position not updated	2200 Hz (50 ms), three beeps every two s
Distress alert, urgency message received	1300 Hz and 2200 Hz (250 ms)

3.4 Interpreting Call Displays

This paragraph provides the information necessary for interpreting receive and send call displays.

3.4.1 Receive calls

Below are sample distress and individual receive calls. The content of other types of receive calls is similar to that of the individual call. When you receive a call, the message "INCOMING" flashes at the bottom of the display.

Distress receive call

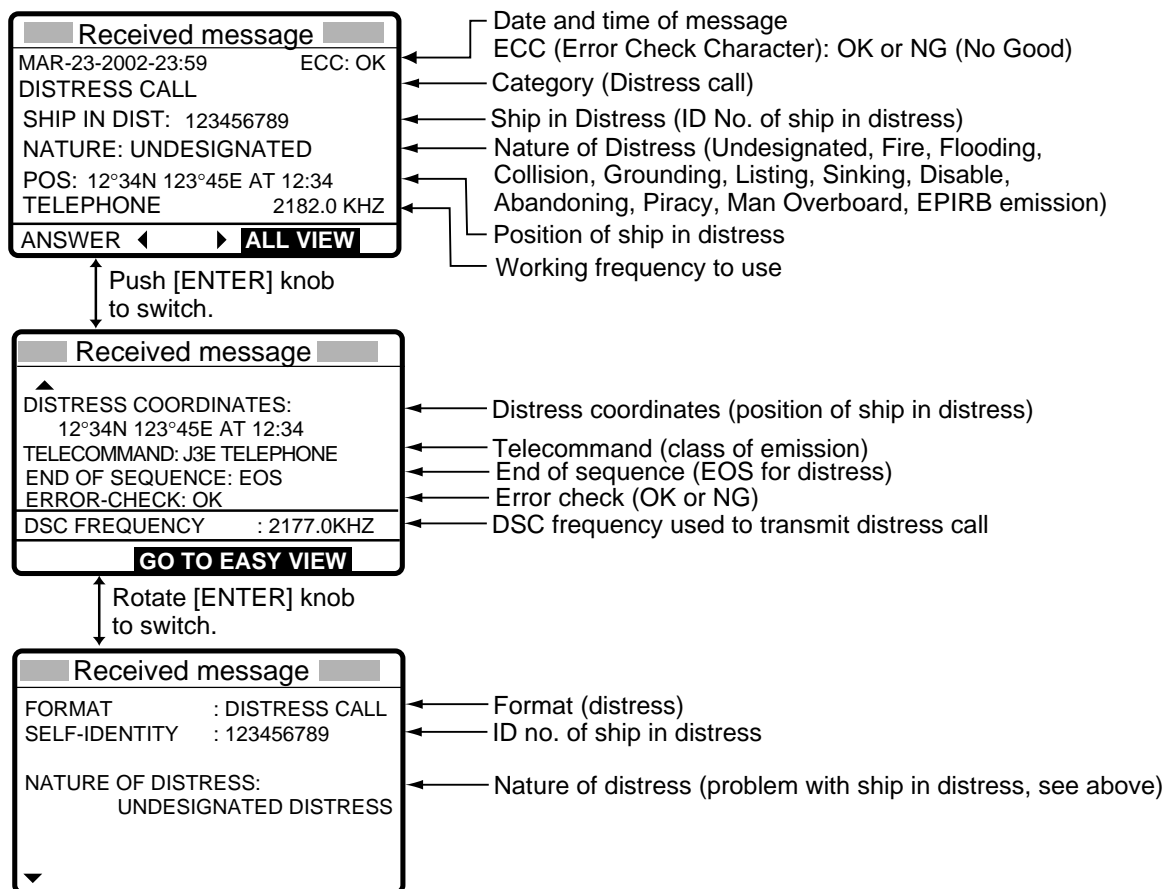

Individual receive call

Received message

MAR-23-2002-23:59 ECC: OK

INDIVIDUAL REQUEST

FROM SHIP: 123456789

ROUTINE TX: 2182.0 KHZ

TELEPHONE RX: 2182.0 KHZ

ANSWER ◀ ▶ ALL VIEW

- ← Date and time of message
 - ← ECC (Error Check Character): OK or NG (No Good)
 - ← Able acknowledge ("Unable acknowledge" and reason if unable)
 - ← ID No. of sending station
 - ← Category (Routine, Business, Safety, Urgency)
 - ← Working frequency to use
- Note:** ANSWER is for replying to message.

↑ Push [ENTER] knob to switch.

Received message

▲

WORKING FREQ. : TX: 2182.0 KHZ

 RX: 2182.0 KHZ

END OF SEQUENCE: ACK. RQ

ERROR-CHECK: OK

DSC FREQUENCY 2177.0KHZ

GO TO EASY VIEW

- ← Working frequency to use
- ← End of sequence (ACK. BQ or ACK. RQ)
- ← Error check (OK or NG)
- ← DSC frequency used

↑ Rotate [ENTER] knob to go to "GO TO EASY VIEW" or push it to go to previous display.

Received message

FORMAT : INDIVIDUAL

ADDRESS : 987654321

CATEGORY : ROUTINE

SELF-IDENTITY : 123456789

1ST TELECOMMAND: J3E TELEPHONE

2ND TELECOMMAND: NO INFORMATION

▼

- ← Format (individual)
- ← ID of your station
- ← Category (Routine, Business, Safety, Urgency)
- ← ID of sending station
- ← 1st Telecommand (class of emission)
- ← 2nd Telecommand (class of emission)

3.4.2 Send calls

Below are sample distress and individual send calls. The content of other types of send calls is similar to that of the individual call.

Distress send call

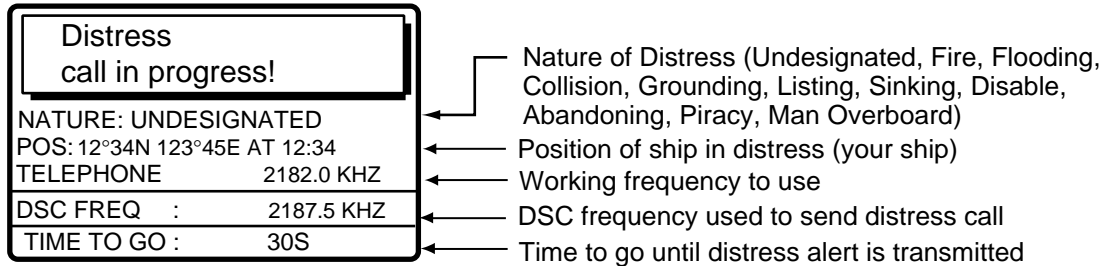

Individual send call

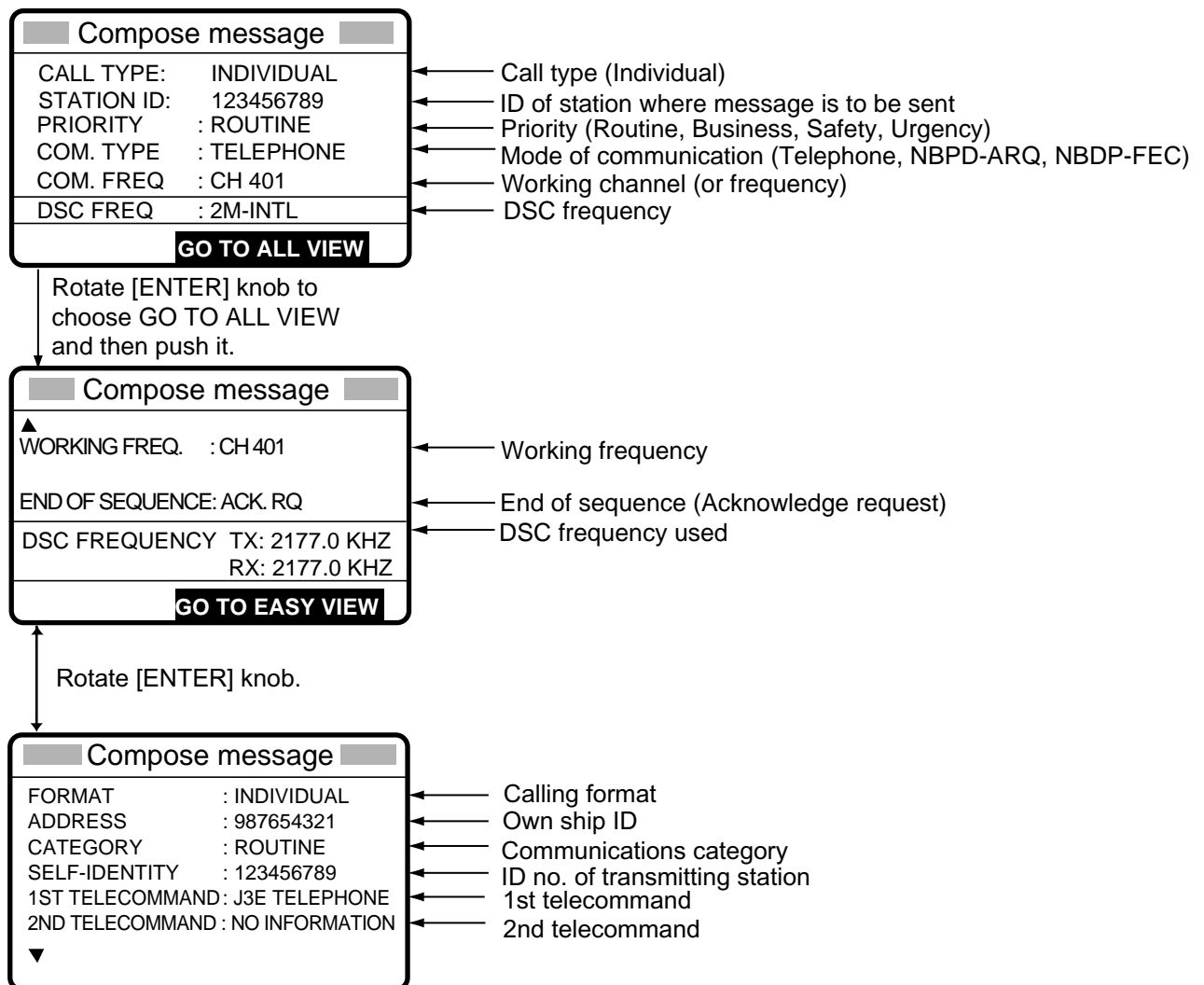

(This page intentionally left blank.)

4 DISTRESS OPERATIONS

4.1 Sending Distress Alert

GMDSS ships carry a DSC terminal with which to transmit the distress alert in the event of a life-endangering situation. A coast station receives the distress alert and sends the distress alert acknowledge call to the ship in distress. Then, voice or telex communications between the ship in distress and coast station begins.

Transmission of the distress alert and receiving of the distress alert acknowledgement are completely automatic - simply press the [DISTRESS] button to initiate the sequence. Note that the distress can also be transmitted from the Telex Distress Alert Button IC-302-DSC.

Russian version

- Audio alarm is released continuously after transmitting distress alert.
- The [CANCEL] key can be used during the transmission of the distress alert. The transmission sequence is stopped at the end of the fifth transmission.

4.1.1 Sending distress alert by DISTRESS button, nature of distress not specified

1. Open the DISTRESS button cover and press and hold down the [DISTRESS] button more than three seconds. The button flashes in red and the buzzer sounds rapidly. The display shows the contents of the distress alert call: your ship's nature of distress, position, time and the DSC frequency over which the alert has been transmitted.

The number of seconds to continue pressing the [DISTRESS] button appear at the bottom of the display. The buzzer sounds continuously and the lamp in the button lights when the button has been pressed three seconds. You can release the button at that time.

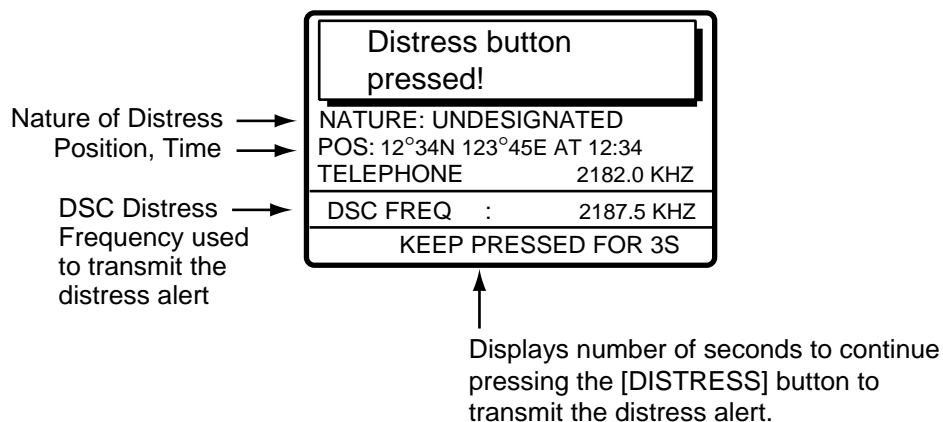

4 DISTRESS OPERATIONS

- The display changes as below. It takes about 40 seconds to transmit the distress alert, and the number of seconds until transmission is completed is shown at the bottom of the display. At this time the output power of the radiotelephone is automatically set to maximum.

Distress call in progress!	
NATURE: UNDESIGNATED	
POS: 12°34N 123°45E AT 12:34	
TELEPHONE	2182.0 KHZ
DSC FREQ :	2187.5 KHZ
TIME TO GO :	38S

↑
Time to go until distress
alert is completely transmitted.

- After the distress alert has been sent, the display changes as below and the audio alarm is stopped. Wait to receive the distress acknowledge call from a coast station, which usually takes 1 to 2 min 45 seconds. (The [DISTRESS] button remains lit until the equipment receives the distress acknowledge call from a coast station.) The timer counts down the number of minutes before next retransmission (if necessary), from 3.5 to 4.5 minutes, randomly set.

At this time, the equipment cannot receive any calls except the distress alert acknowledge call. The distress alert you sent is recorded in the TX log.

Wait for distress acknowledgement.	
NATURE: UNDESIGNATED	
POS: 12°34N 123°45E AT 12:34	
TELEPHONE	2182.0 KHZ
DSC FREQ :	2187.5 KHZ
TIME TO GO:	2M10S

- When the distress acknowledge call is received, the audio alarm sounds and the display changes as below.

Distress acknowledge call received.	
FROM COAST: 001234567	
SHIP IN DIST: 123456789	
NATURE: UNDESIGNATED	
POS: 12°34N 123°45E AT 12:34	
TELEPHONE	2182.0 KHZ
STOP ALARM	

Note: If you do not receive the distress alert acknowledge call, the equipment automatically re-transmits the distress alert and then awaits the distress alert acknowledge call. This is repeated until the distress alert is acknowledged.

- Silence the alarm with the [CANCEL] key. The contents of the distress acknowledge call appear.

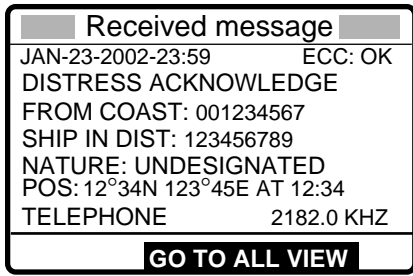

6. Communicate with the coast station via radiotelephone, following the instructions below. The radiotelephone automatically sets working frequency and class of emission, as specified in the distress acknowledge call.
 - a) Say MAYDAY three times.
 - b) Say “This is ... “ name of your vessel and call sign three times.
 - c) Give nature of distress and assistance needed.
 - d) Give description of your vessel (type, color, number of persons onboard, etc.).

4.1.2 Sending distress alert by DISTRESS button, nature of distress specified

If you have the time to designate the nature of distress, send the distress alert as follows:

1. Open the DISTRESS button cover and press the [DISTRESS] button momentarily to show the following display.

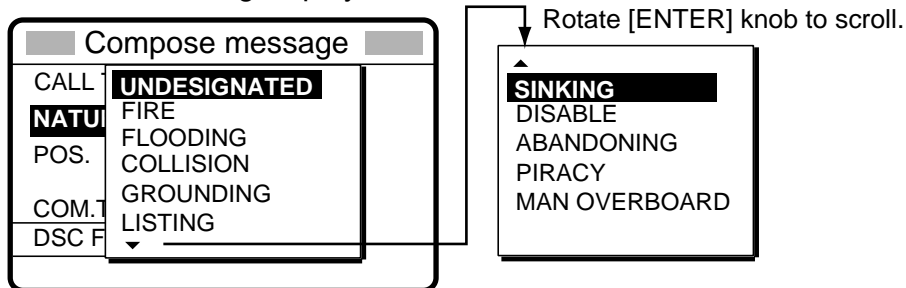

2. Rotate the [ENTER] knob to choose nature of distress and then push the [ENTER] knob.
3. Push the [ENTER] knob to open the POS. menu. This is where you enter your position, automatically or manually. The INPUT TYPE option, that is, the source of position data, is selected to AUTO, MANUAL or NO INFO. For AUTO, if the position is correct, push the [ENTER] knob twice and go to step 10. For manual input, or you do not know your position, go to step 4.

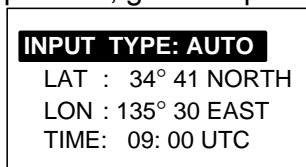

Note: If the message “No Position Data” appears when you change INPUT TYPE from MANUAL to AUTO, confirm that the navigation device is functioning and then choose AUTO again.

4 DISTRESS OPERATIONS

4. Push the [ENTER] knob to open the INPUT TYPE menu.

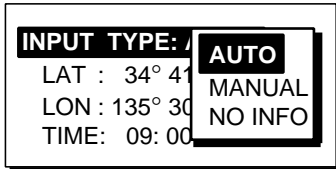

5. Rotate the [ENTER] knob to choose MANUAL and then push the [ENTER] knob. If you cannot confirm your position, choose NO INFO, push the [ENTER] knob and then go to step 10.
6. Push the [ENTER] knob to open the latitude input window. Use the numeric keys to enter latitude (in four digits). (If necessary, switch coordinates: [1] key to switch to North; [2] key to switch to South.) Push the [ENTER] knob.

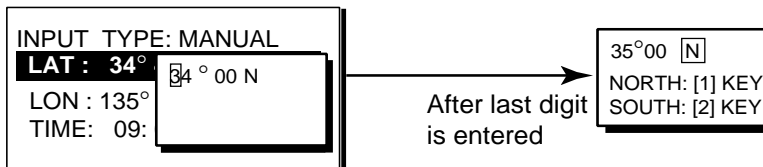

7. Push the [ENTER] knob to open the longitude input window. Use the numeric keys to enter longitude (in five digits). (If necessary, switch coordinates: [1] key to switch to East; [2] key to switch to West.) Push the [ENTER] knob.

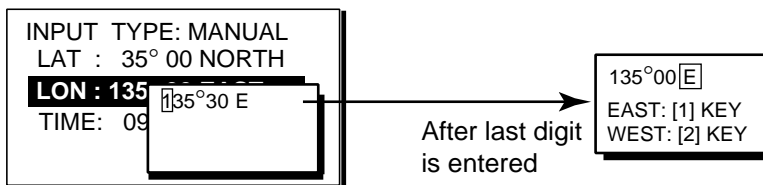

8. Push the [ENTER] knob to open the time input window.

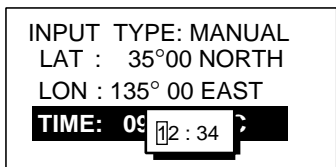

9. Key in UTC time with the numeric keys and then push the [ENTER] knob.

Note: If you cannot confirm time, enter 88:88 to input NO INFO as the time.

10. The COMPOSE MESSAGE screen is redisplayed. Push the [ENTER] knob to open the COM. TYPE menu.

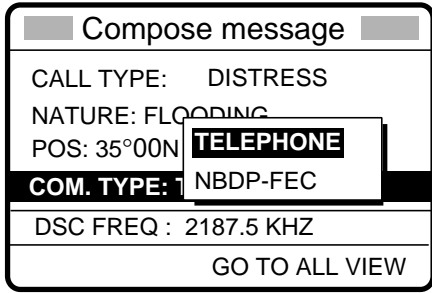

11. Rotate the [ENTER] knob to choose TELEPHONE or NBDP-FEC as appropriate and then push the [ENTER] knob. (Telephone is the usual mode, however NBDP may also be used.)

12. Push the [ENTER] knob to open the DSC FREQ menu.

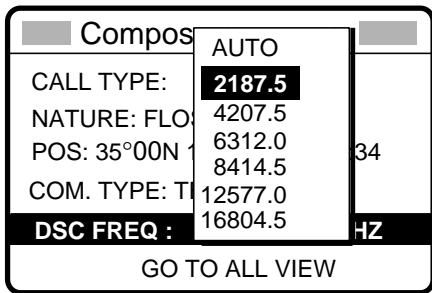

13. Rotate the [ENTER] knob to choose a DSC frequency (normally 2187.5 kHz) and then push the [ENTER] knob. (AUTO retransmits the distress alert on the distress and safety frequencies 2 MHz, 8 MHz, 16 MHz, 4 MHz, 12 MHz and 6 MHz in that order if the distress alert is not acknowledged.)

14. The display changes as below (example).

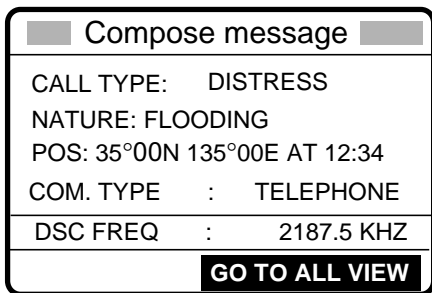

15. Press the [DISTRESS] button more than three seconds to send the distress alert.

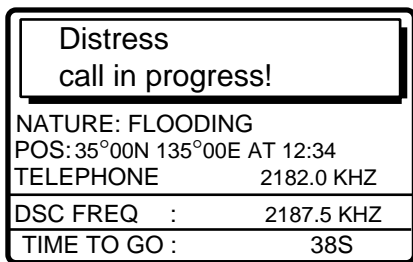

16. For telephone, follow steps 3 to 6 on page 4-2 and 4-3. For NBDP, follow the procedure below.

Communicating by NBDP Terminal Unit

1. The message "STATION ENTRY COMPLETED FROM DSC. Press any key to escape." appears on the NBDP's display. Press any key on the NBDP Terminal Unit to erase the message.
2. Press the function key [F3] on the keyboard of the NBDP Terminal Unit to show the Operate menu.
3. Choose "Call Station" and then press the [Enter] key.

Call Station	
Station List	Station Set up
DSC	Station : DSC
ABC-6M	ID Code :
ABC-12M	Mode : ARQ <u>FEC</u>
ABC-8M	Tx Freq : 2174.50
FURUNO	Rx Freq : 2174.50

4. "DSC" is selected; press the [Enter] key to connect the communications line.
5. "Connect" appears in reverse video. Type and transmit your message, giving the following information:
 - a) Ship's name and call sign
 - b) Nature of distress and assistance needed
 - c) Description of your vessel
6. Press the function key [F10] (BREAK) to disconnect the line.

4.2 Receiving a Distress Alert

When you receive a distress alert from a ship in distress, the audio alarm sounds and the message "Distress call received." appears on the display. Press the [CANCEL] key to silence the audio alarm. Wait for the distress acknowledge call from a coast station. If you do not receive the distress acknowledge call from a coast station, which usually takes about five minutes from the time of reception of a distress alert, follow the appropriate flow chart in this section to determine your course of action.

Note 1: An asterisk (*) appearing in a distress alert call indicates error at asterisk location.

Note 2: If the Telex Distress Alert Button IC-302-DSC is connected, the aural alarm sounds and the IC-302-DSC's alarm lamp lights in red when a distress alert is received. To silence the aural alarm, press the [ALARM STOP] key.

Russian version

If another distress alert or urgent call is received just after pressing the [CALL] key (for distress alert relay and distress acknowledgement), the most recently received call has priority.

4.2.1 Distress alert received on MF band

Do the following:

- Continue watching on 2182 kHz. Wait for coast station to acknowledge the distress call. Watch until "SEELONCE FINI" is announced.
- If multiple DSC distress alerts are received from the same ship in distress and it is beyond a doubt in your vicinity, a DSC acknowledgement may, after consultation with an RCC or Coast Station, be sent to terminate the call by DSC.
- In no case is a ship permitted to transmit a DSC distress relay call upon receipt of a DSC distress alert on MF channel 2187.5 kHz.

Action for ship receiving distress alert on MF band

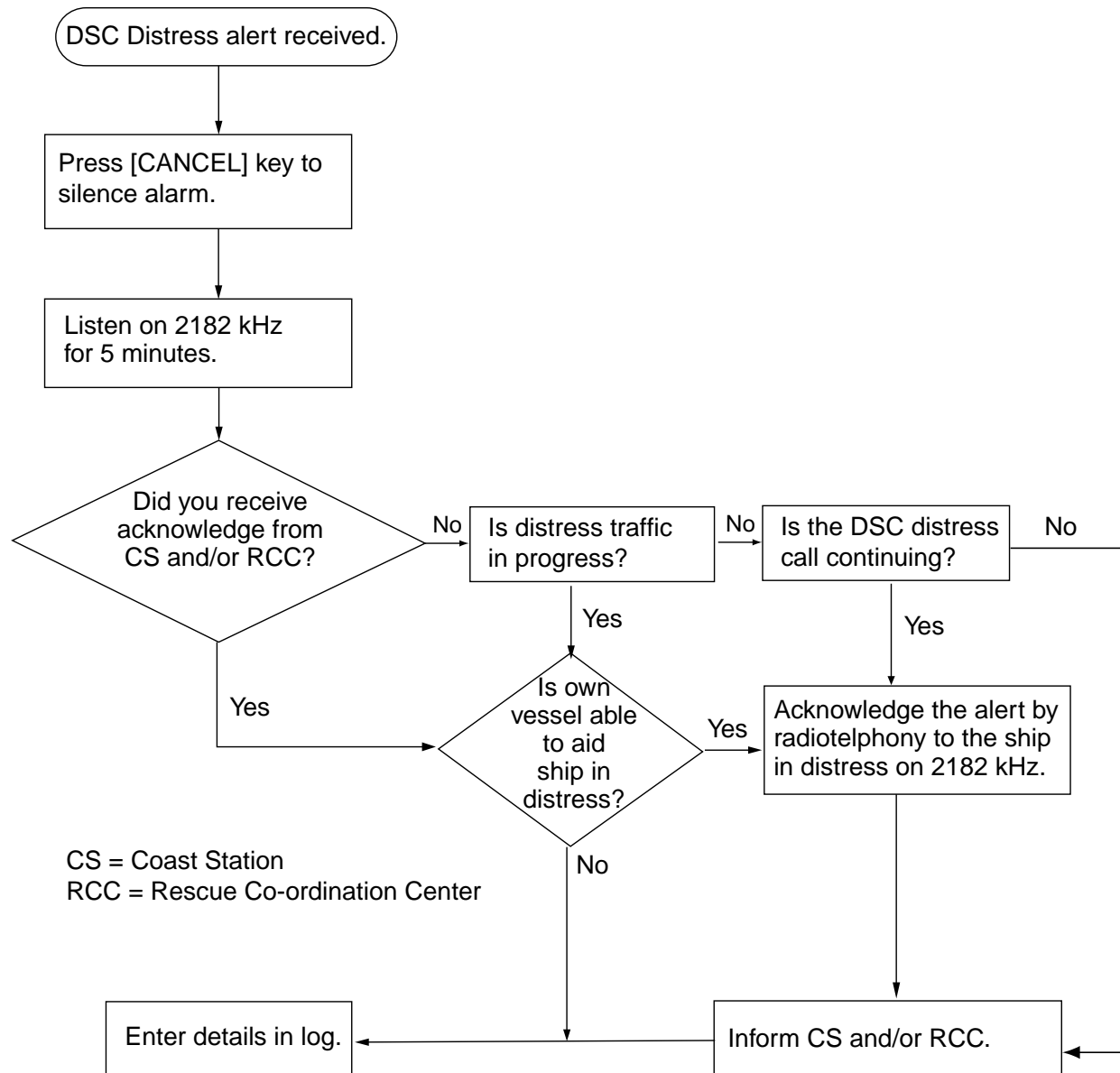

Sending the distress acknowledge call to ship in distress (on MF band)

Transmit the distress acknowledge call to the ship in distress only when you do not receive it from a coast station and **you are able to aid the ship in distress**. First, transmit the distress acknowledge to the ship in distress by telephone. If the DSC call is continuing, terminate transmission of the distress alert as follows:

1. The audio alarm sounds and the display shows the message “Distress call received.” when your ship receives a distress call.

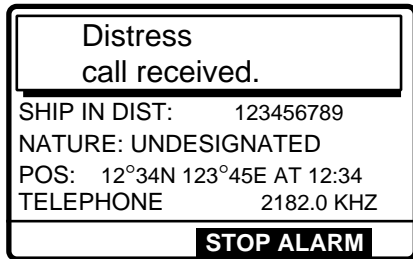

2. Press the [CANCEL] key to silence the audio alarm and the display changes as below.



3. **If you do not receive the distress acknowledge call from a coast station and you have received the distress alert more than twice**, contact the ship in distress over radiotelephone. If the distress alert continues, terminate the alert by rotating the [ENTER] knob to choose ANSWER, push the [ENTER] knob and then go to step 4 to send the distress acknowledge call to the ship in distress.
4. Push the [ENTER] knob to open the CALL TYPE menu.

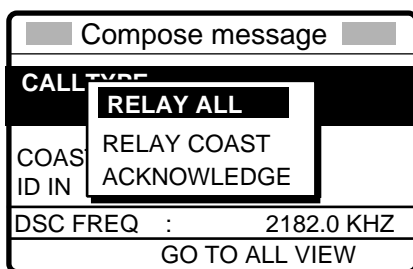

5. Rotate the [ENTER] knob to choose ACKNOWLEDGE and then push the [ENTER] knob. The following display appears.

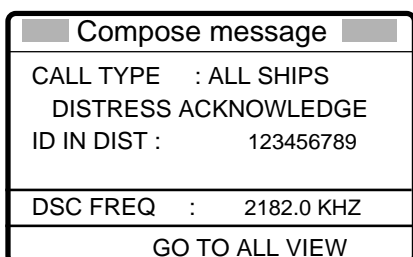

6. Press the [CALL] key, and the message “Category distress transmit sure?” appears. Continue press the key until the message “Distress acknowledge call in progress” appears, to transmit the distress acknowledge call to the ship in distress.

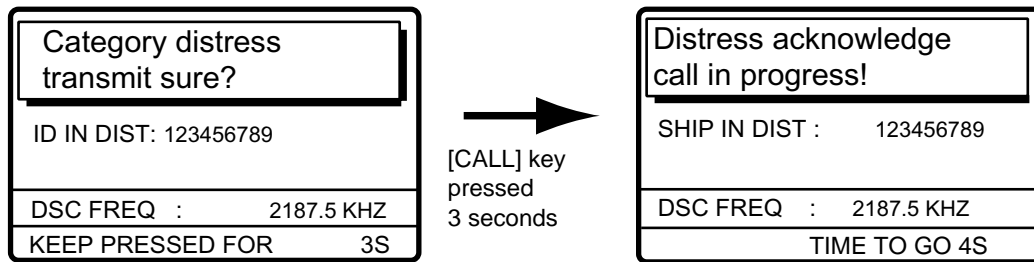

4.2.2 Distress alert received on HF band

If you receive a distress alert on the HF band, the ALARM lamp lights and the audio alarm sounds. Press the [CANCEL] key to silence the audio alarm. Wait for the distress acknowledge from a coast station. If you do not receive the distress acknowledge within five minutes, follow the instructions below to determine your course of action.

- Watch on the distress frequency.
- Relay the distress alert in the following cases:
 - You have not received a distress acknowledge call from a coast station within five minutes after receiving a distress call.
 - You have not received a distress relay from other ship.
 - You cannot receive distress communications from other ship over radiotelephone.
 - If it is clear the ship or persons in distress are not in the vicinity and/or other crafts are better placed to assist, superfluous communications which could interfere with search and rescue activities should be avoided. Details should be recorded in the appropriate log book.
 - The ship relaying the distress alert should establish communications with the station controlling the distress as directed and render such assistance as required and appropriate.

Action for ships receiving distress alert on HF band

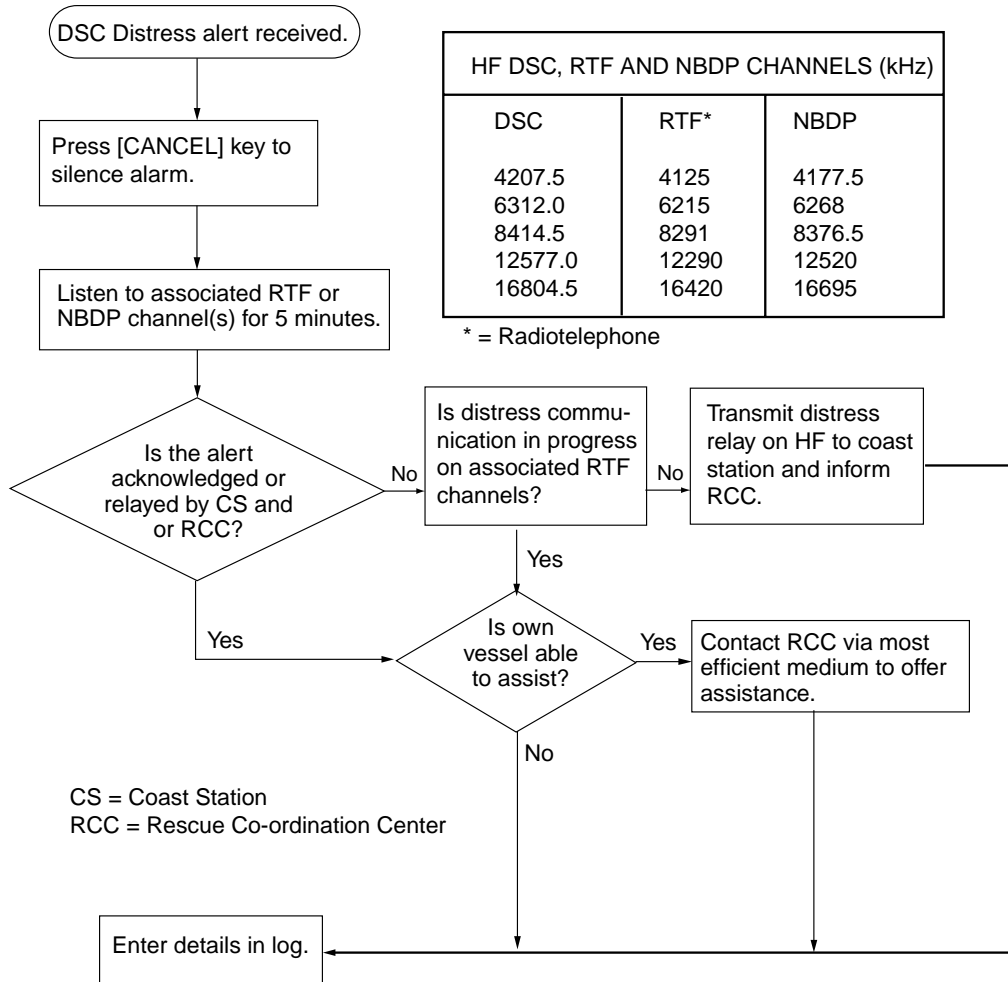

Sending the distress relay to coast station (on HF band)

1. The audio alarm sounds and the display changes as below when a distress call is received.

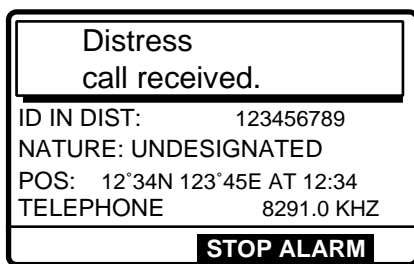

2. Press the [CANCEL] key to silence the audio alarm, and the display changes as below.



3. Rotate the [ENTER] knob to choose ANSWER and then push the [ENTER] knob.

4. Push the [ENTER] knob to open the CALL TYPE menu.



5. If you know the ID of the nearest coast station, choose RELAY COAST and then push the [ENTER] knob.
6. Push [ENTER] knob and key in ID of coast station where to send the distress relay and then push the [ENTER] knob.

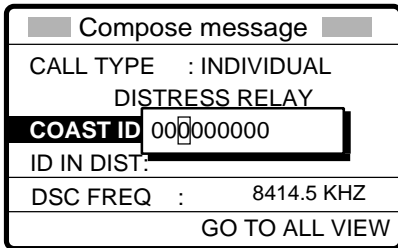

7. Push the [ENTER] knob to open the DSC FREQ. menu.

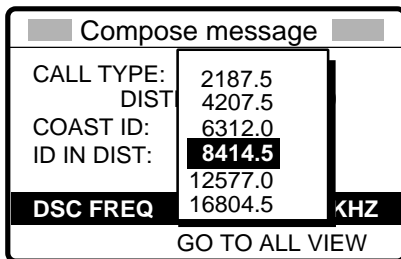

8. Choose appropriate frequency and then push the [ENTER] knob. You should first choose 8414.5 kHz.
9. Press the [CALL] key, and the display changes as shown at the top of the next page.

4 DISTRESS OPERATIONS

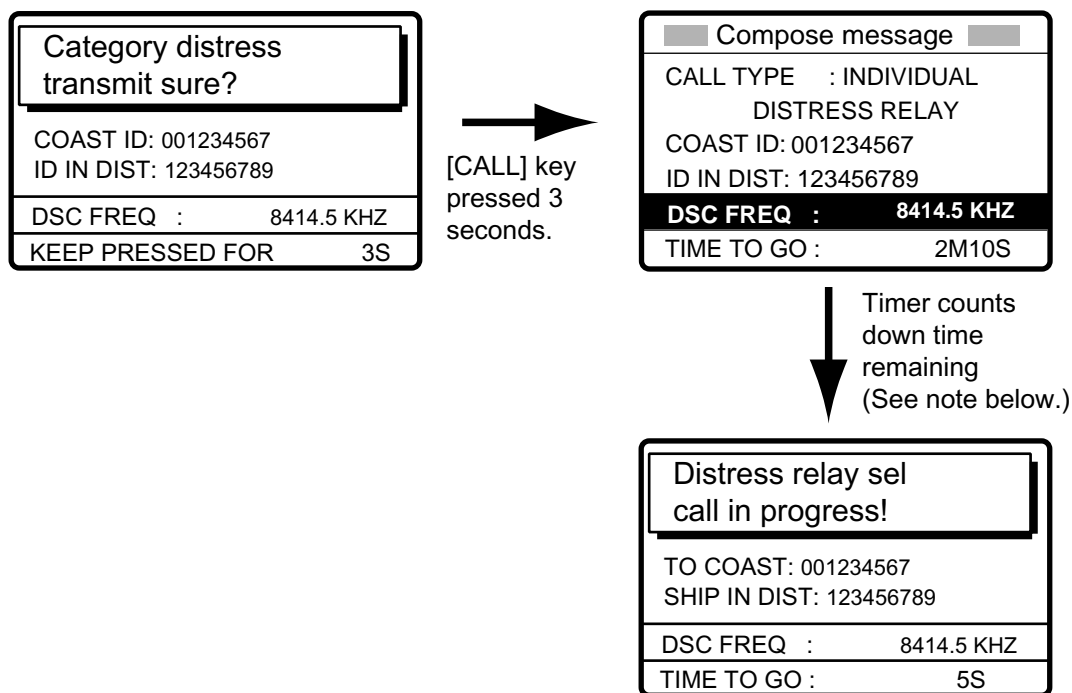

Note: If a coast station acknowledges the call before the timer counts down to zero, press the [CANCEL] key to cancel the distress relay call.

10. After the call is transmitted, the message "Wait for distress relay acknowledge." appears. After you have received the distress acknowledgement from the coast station, communicate with the coast station by telephone, over the DSC frequency specified. If you do not receive the distress acknowledgement from a coast station after the timer counts down to zero, transmit the distress relay again, over a different frequency.

4.3 Sending Distress Relay on Behalf of a Ship in Distress

4.3.1 Sending distress relay to coast station

You may send the distress relay to a coast station on behalf of a ship in distress in the following cases:

- You are near the ship in distress and the ship in distress cannot transmit the distress alert.
- When the master or person responsible for your ship considers that further assistance is necessary.

In the above cases never use the [DISTRESS] button to transmit the distress relay.

1. Press the [2/DSC] key and then push the [ENTER] knob.

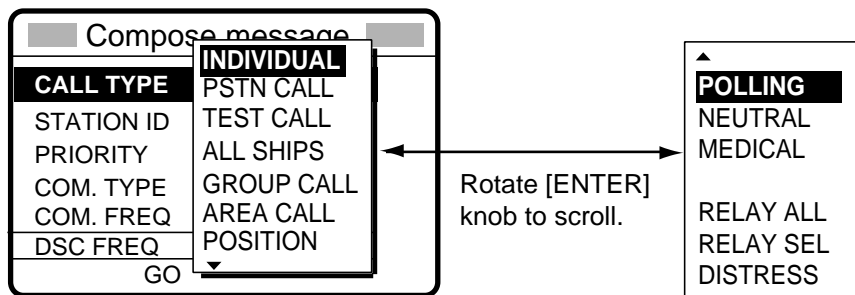

2. Rotate the [ENTER] knob to choose RELAY SEL and then push the [ENTER] knob.
3. Push the [ENTER] knob to open the COAST ID input window.

The screenshot shows the 'Compose message' screen with the following fields: CALL TYPE: RELAY SEL, COAST ID (highlighted), ID IN DIST (input field with '00000000'), NATURE: UNDESIGNATED, POS: NO INFORMATION, COM. TYPE: TELEPHONE, DSC FREQ.: 8414.5 KHZ, and GO TO ALL VIEW at the bottom.

4. Key in COAST ID with the numeric keys and then push the [ENTER] knob.
5. Push the [ENTER] knob to open the ID IN DIST window.

The screenshot shows the 'Compose message' screen with the following fields: CALL TYPE: RELAY SEL, COAST ID (input field with '00000000'), ID IN DIST (highlighted, input field with '00000000'), NATURE: UNDESIGNATED, POS.: NO INFORMATION, COM. TYPE: TELEPHONE, DSC FREQ.: 8414.5 KHZ, and GO TO ALL VIEW at the bottom.

6. Key in ID of ship in distress with the numeric keys and then push the [ENTER] knob. If you do not know the ID, simply push the [ENTER] knob without entering ID.

4 DISTRESS OPERATIONS

7. Push the [ENTER] knob to open the NATURE menu.

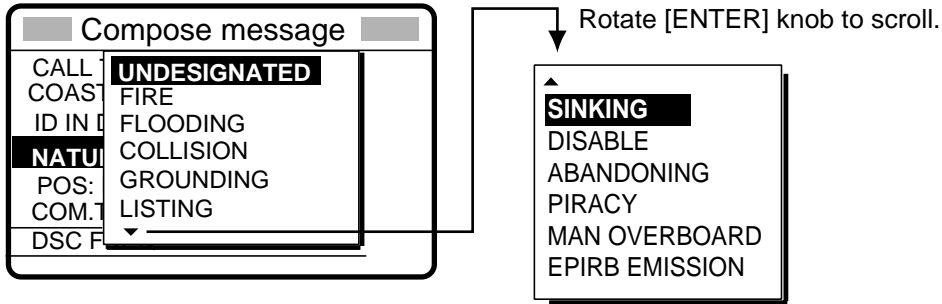

8. Rotate the [ENTER] knob to choose nature of distress and then push the [ENTER] knob. If you do not know the nature of distress, choose UNDESIGNATED.

9. Push the [ENTER] knob to open the POS. menu.

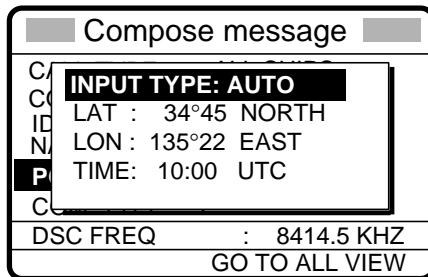

10. Enter position of ship in distress, following 1), 2) or 3) below.

1) For automatic input, push the [ENTER] knob twice and then go to step 11.

2) For manual input, push the [ENTER] knob to open the INPUT TYPE menu, rotate the [ENTER] knob to choose MANUAL and then push the [ENTER] knob. Enter latitude and longitude of ship in distress and time as follows:

a) Push the [ENTER] knob. Enter latitude and then push the [ENTER] knob.

b) Push the [ENTER] knob. Enter longitude and then push the [ENTER] knob.

c) Push the [ENTER] knob. Enter UTC time and then push the [ENTER] knob. Go to step 11.

Note: If you cannot confirm time, enter 88:88 to input NO INFO as the time.

3) If you cannot confirm position of ship in distress, push the [ENTER] knob to open the INPUT TYPE menu, rotate the [ENTER] knob to choose NO INFO and then push the [ENTER] knob. Go to step 11.

11. Push the [ENTER] knob to open the COM. TYPE menu.



12. Rotate the [ENTER] knob to choose TELEPHONE and then push the [ENTER] knob. (NBDP-FEC may also be used.) Push the [ENTER] knob to open the DSC FREQ menu.

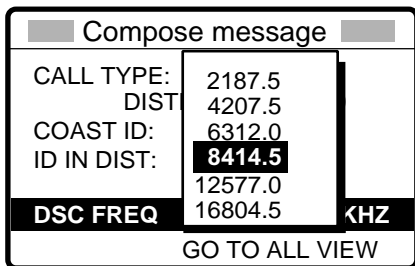

13. Rotate the [ENTER] knob to choose appropriate DSC (NBDP) frequency and then push the [ENTER] knob. The display now looks something like the one below in case of radiotelephone.



14. Press the [CALL] key, and the message “Category distress transmit sure?” appears. Continue pressing the key until the display shows “Distress relay sel call in progress!” to send the distress relay call.

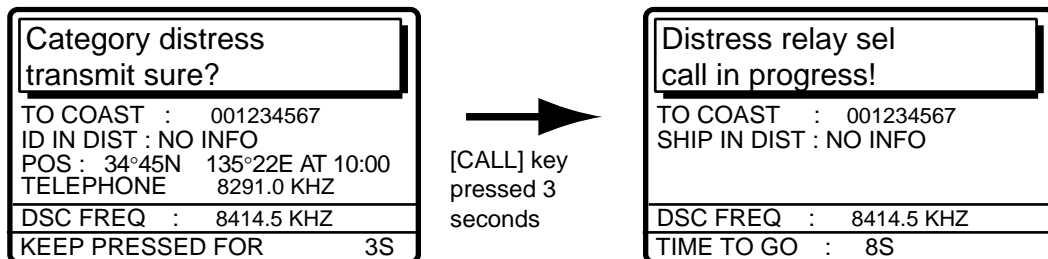

15. The equipment then waits for acknowledgement of the distress relay, displaying the message shown below. If the distress relay is not acknowledged within five minutes, the message “No response. Try relay again.” appears. If this occurs, send the distress relay again.

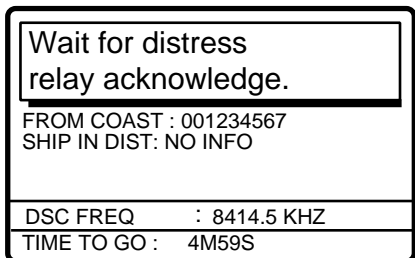

4 DISTRESS OPERATIONS

16. When you receive the distress relay acknowledge call, the audio alarm sounds and the display shown below appears.



17. Press the [CANCEL] key to silence the audio alarm. The following display appears.

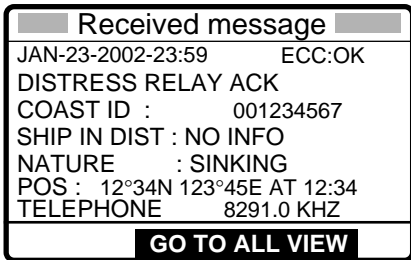

18. Communicate with the coast station.

4.3.2 Sending distress relay to all ships

Use this procedure to send the distress relay to all ships.

1. Press the [2/DSC] key and then push the [ENTER] knob.

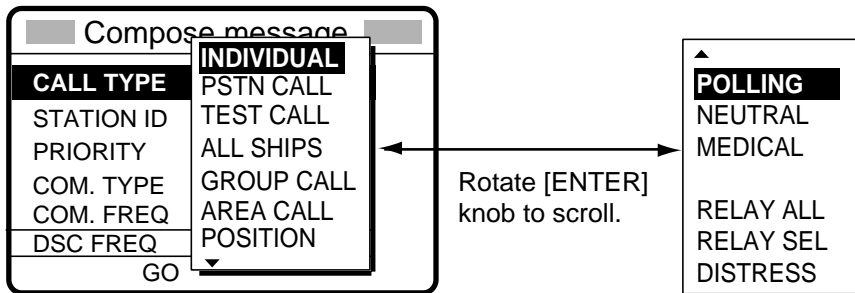

2. Rotate the [ENTER] knob to choose RELAY ALL and then push the [ENTER] knob.

3. Push the [ENTER] knob to open the ID IN DIST menu.

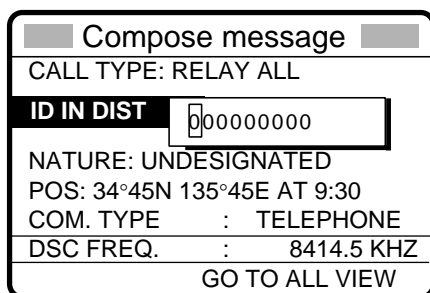

4. Key in ID of ship in distress (if known) with the numeric keys and then push the [ENTER] knob. (If you do not know the ID enter push the [ENTER] knob without entering ID.)

5. Push the [ENTER] knob to open the NATURE menu.

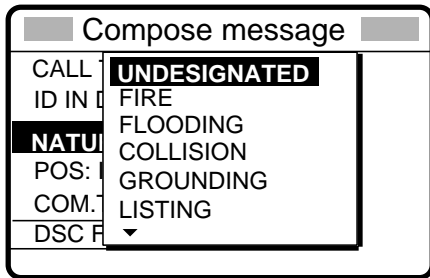

6. Rotate the [ENTER] knob to choose nature of distress and then push the [ENTER] knob. (If you do not know the nature of distress, choose UNDESIGNATED.)
7. Push the [ENTER] knob to open the POS. menu, where you enter the position of the ship in distress and time, manually or automatically.

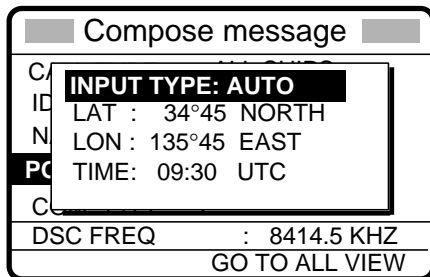

8. Enter position of the ship in distress, following 1), 2) or 3) below.

1) For automatic input, push the [ENTER] knob twice. Go to step 9.

2) For manual input, push the [ENTER] knob to open the INPUT TYPE menu, rotate the [ENTER] knob to choose MANUAL and then push the [ENTER] knob. Enter latitude and longitude of ship in distress and time as follows:

- Push the [ENTER] knob. Enter latitude and then push the [ENTER] knob.
- Push the [ENTER] knob. Enter longitude and then push the [ENTER] knob.
- Push the [ENTER] knob. Enter UTC time and then push the [ENTER] knob. Go to step 9.

Note: If you cannot confirm time, enter 88:88 to input NO INFO as the time.

3) If you cannot confirm position of ship in distress, push the [ENTER] knob to open the INPUT TYPE menu, rotate the [ENTER] knob to choose NO INFO and then push the [ENTER] knob. Go to step 9.

9. Push the [ENTER] knob to open the COM. TYPE menu.

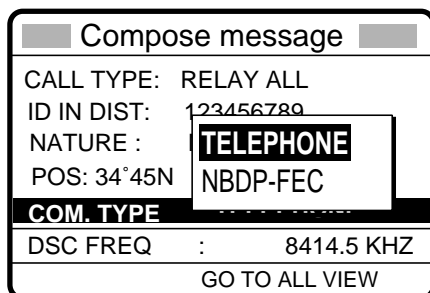

10. Rotate the [ENTER] knob to choose TELEPHONE (or NBDP-FEC) and then push the [ENTER] knob.

4 DISTRESS OPERATIONS

11. Push the [ENTER] knob to open the DSC FREQ menu.

Compose message	
CALL TYPE:	2187.5
ID IN DIST:	4207.5
NATURE: UN	6312.0
POS: 34°45N	8414.5
COM TYPE:	12577.0
DSC FREQ	16804.5 KHZ
GO TO ALL VIEW	

12. Rotate the [ENTER] knob to choose appropriate frequency and then push the [ENTER] knob. The display now looks something like the one below.

Compose message	
CALL TYPE:	RELAY ALL
ID IN DIST:	123456789
NATURE:	UNDESIGNATED
POS:	34°45N 135°45E AT 09:30
COM TYPE :	TELEPHONE
DSC FREQ :	8414.5 KHZ
GO TO ALL VIEW	

13. Press the [CALL] key, and the message “Category distress transmit sure!” appears. Continue pressing the key until the display shows “Distress relay all call in progress!” to send the distress relay call.

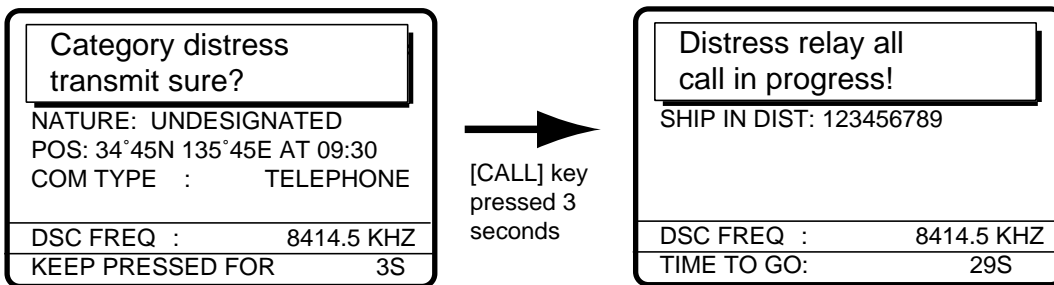

14. After the call is sent, the radiotelephone screen automatically appears.

4.4 Receiving Distress Relay All Ships

When you receive a distress relay for all ships, continue monitoring distress and safety frequencies.

1. The audio alarm sounds and the display looks like the one below when a distress relay all ships call is received.

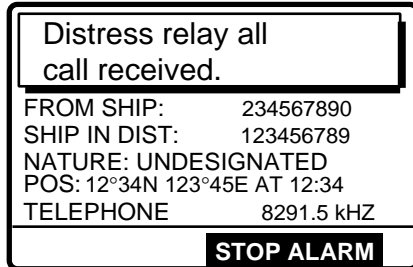

2. Press the [CANCEL] key to silence the alarm, and the display changes as below.

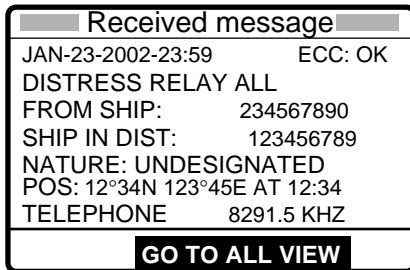

3. Press the [CANCEL] key to go to the radiotelephone screen.
4. Watch distress/safety frequency.

4.5 Receiving Distress Relay from Coast Station

When you receive a distress relay call from a coast station, continue monitoring distress and safety frequencies.

1. The audio alarm sounds and the display looks like the one in the left-hand figure below when a distress relay is received from a coast station. Press the [CANCEL] key to silence the audio alarm, and the display changes as in the right-hand figure below.

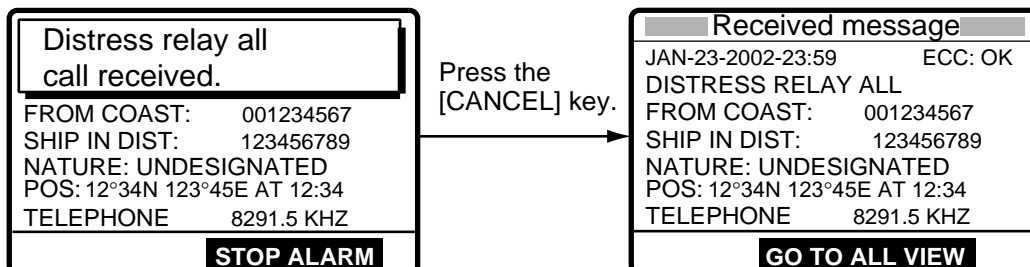

2. Press the [CANCEL] key to go to the radiotelephone screen.
3. Watch distress/safety frequency.

4 DISTRESS OPERATIONS

(This page intentionally left blank.)

5 CALLING, RECEIVING

This chapter provides the information necessary for general calling and receiving.

5.1 All Ships Call

When an urgent but not life-endangering situation arises on your ship, for example, engine trouble, send an all ships call to request assistance.

After sending the call, you can communicate by voice over the radiotelephone, or send a message by telex. For telephone, do the following before beginning actual communications:

URGENCY priority: Say PAN three times followed by your call sign.

SAFETY priority: Say SECURITE three times followed by your call sign.

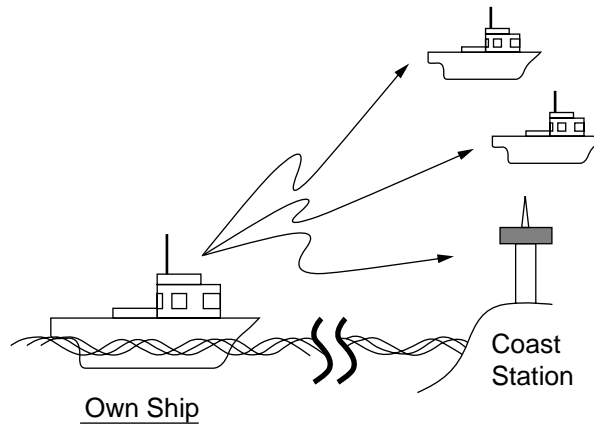

5.1.1 Sending an all ships call

1. Press the [2/DSC] key followed by pushing the [ENTER] knob to display the CALL TYPE menu.

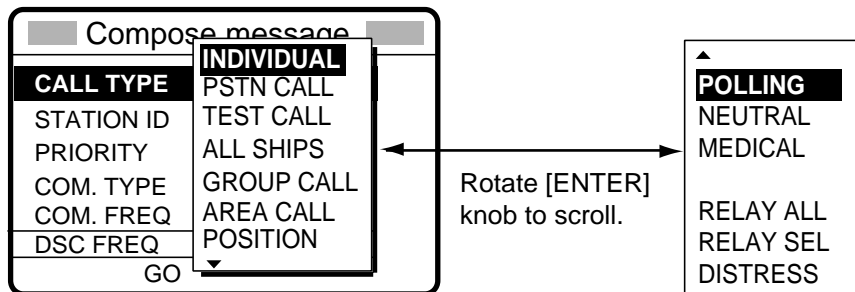

2. Rotate the [ENTER] knob to choose ALL SHIPS and then push the [ENTER] knob.

5 CALLING, RECEIVING

3. Push the [ENTER] knob to display the PRIORITY menu.

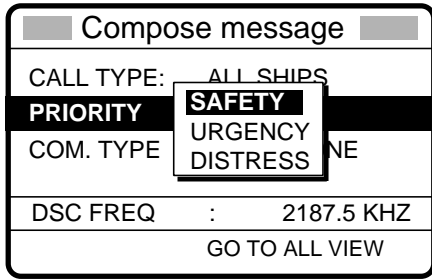

4. Rotate the [ENTER] knob to choose SAFETY or URGENCY as appropriate and then push the [ENTER] knob. (DISTRESS should be used only when there is a life endangering situation on board your vessel.)

5. Push the [ENTER] knob to open the COM. TYPE menu.

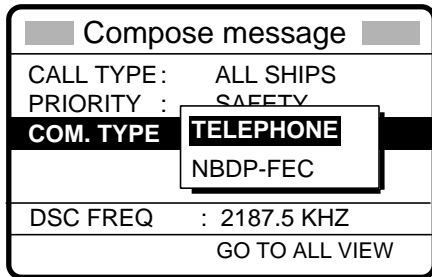

6. Rotate the [ENTER] knob to choose appropriate communications mode and then push the [ENTER] knob.

7. Push the [ENTER] knob to open the DSC FREQ menu.

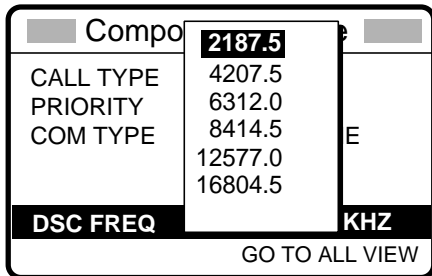

8. Rotate the [ENTER] knob to choose frequency and then push the [ENTER] knob.

9. Press the [CALL] key to send the call. For safety and urgency call the display shows "All ships call in progress." For distress call, the display shows "Category distress transmit sure? If you are sure to transmit with distress priority, continue pressing the [CALL] key to show "All ships call in progress!".

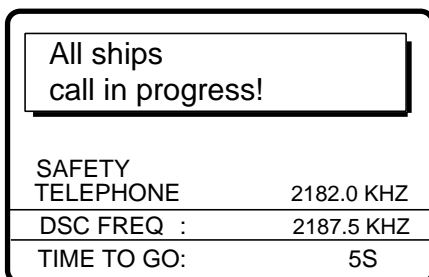

10. The radiotelephone screen automatically appears after the call is sent (timer counts down to zero). The equipment is then set up for telephone (or NBDP) and safety or urgency priority, using DSC pair frequencies.

Sending message by NBDP Terminal Unit

1. The message "STATION ENTRY COMPLETED FROM DSC. Press any key to escape." appears on the NBDP's display. Press any key on the NBDP Terminal Unit to erase the message.
2. Press the function key [F3] on the keyboard of the NBDP Terminal Unit to show the Operate menu.
3. Choose "Call Station" and then press the [Enter] key.
4. "DSC" is selected; press the [Enter] key. "Connect" appears in reverse video.
5. Type and transmit your message.
6. When you have finished sending your message, press the [F10] key to disconnect the line.

5.1.2 Receiving an all ships call

1. When an all ships call is received, the audio alarm sounds and the display looks something like the one shown below.

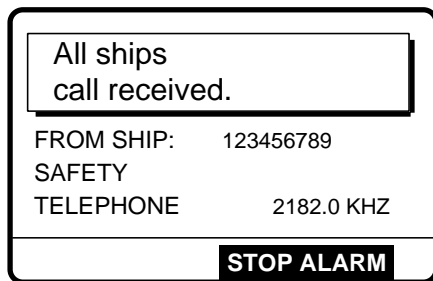

2. Press the [CANCEL] key to silence the alarm. The display shows partial contents of the all ships call as below.

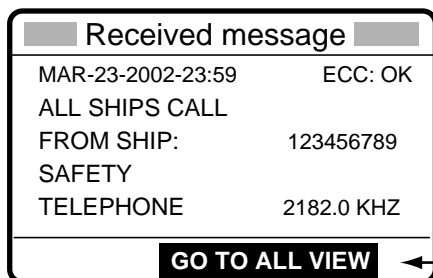

← To view detailed contents, push the [ENTER] knob.

3. Press the [CANCEL] key again to go to the radiotelephone screen. Watch for communications about all ships call on the radiotelephone.

5.2 Individual Call

The individual call is for calling a specific station. After sending an individual call, called ACK RQ transmission, wait to receive the acknowledge back (ACK BQ) signal from the receiving station.

5.2.1 Sending an individual call

1. Press the [2/DSC] key and then push the [ENTER] knob to open the CALL TYPE menu.

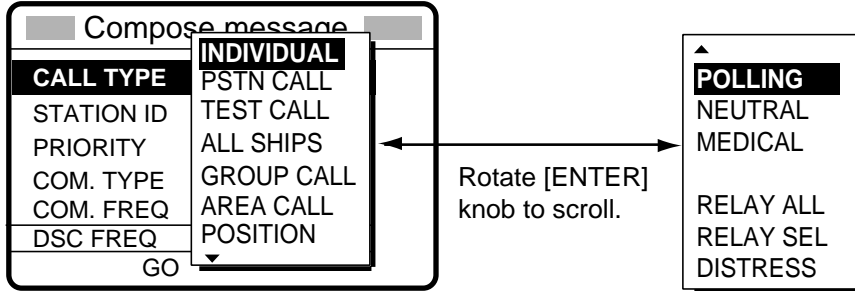

2. Rotate the [ENTER] knob to choose INDIVIDUAL and then push the [ENTER] knob.
3. Push the [ENTER] knob to open the STATION ID menu.

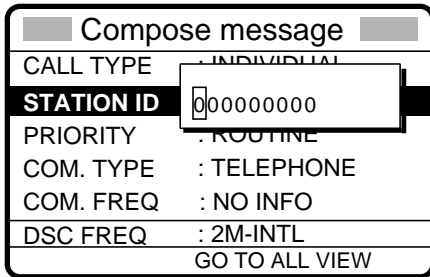

4. Use the numeric keys to key in the ID of the station where to send the call and then push the [ENTER] knob.
5. Push the [ENTER] knob to open the PRIORITY menu.

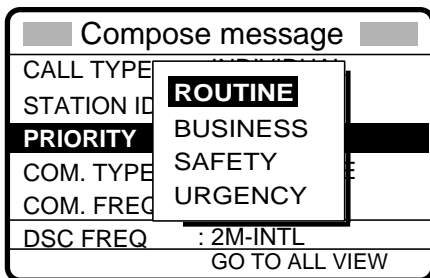

6. Rotate the [ENTER] knob to choose appropriate priority (normally ROUTINE) and then push the [ENTER] knob.
7. Push the [ENTER] knob to open the COM. TYPE menu.

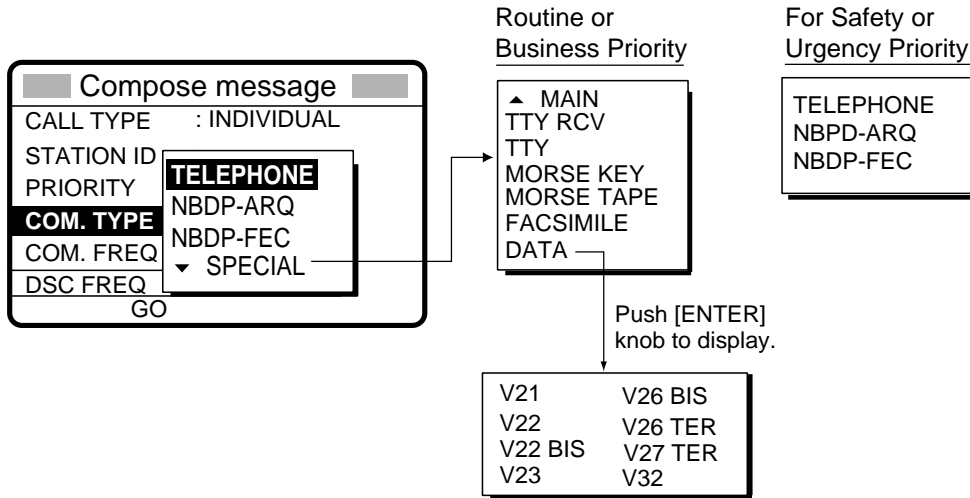

8. Rotate the [ENTER] knob to choose communications type desired and then push the [ENTER] knob.
9. **For routine and business priority**, push the [ENTER] knob to open the COM. FREQ menu. **For safety and urgency priority**, go to step 11.

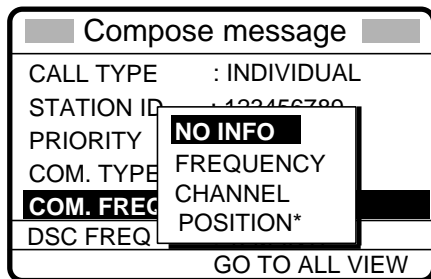

* POSITION is displayed if a coast station is specified at step 3.

10. Rotate the [ENTER] knob to choose communication frequency setting method desired and then push the [ENTER] knob. For FREQUENCY and CHANNEL, see “How to Set Working Frequency, Channel” on the next page. NO INFO and POSITION let the receiving station set the working frequency. Choose NO INFO or POSITION to send the call to a coast station; FREQUENCY or CHANNEL to send the call to a ship station.

How to Set Working Frequency, Channel

To send a call, set the working frequency as below, to communicate with the receiving station. The working frequency can be entered by Tx and Rx frequencies or channel number.

Routine or ship's business priority

1. After selecting FREQUENCY or CHANNEL, one of the following pop-up windows appears.

TX:	0.0	KHZ
RX:	0.0	KHZ

Frequency

CH:	0
-----	---

Channel

2. Key in TX frequency or channel with the numeric keys. (For channel, push the [ENTER] knob to finish.)
3. Rotate the [ENTER] knob to choose the RX field, key in RX frequency and then push the [ENTER] knob to finish.

Safety or urgency priority

For safety or urgency priority the communication frequency cannot be selected; it is automatically set to the pair frequency as set for the DSC frequency.

11. Follow the instructions on the next page to choose DSC frequency desired.

How to Set DSC Frequency

Routine or ship's business priority

1. Rotate the [ENTER] knob to choose DSC FREQ and then push the [ENTER] knob.

The screenshot shows the 'Compose message' screen with the following fields: CALL TYPE: 2 MHz, STATION ID: 4 MHz, PRIORITY: 6 MHz, COM. TYP: 8 MHz, COM. FREQ: 12 MHz. At the bottom, 'DSC FREQ' is highlighted, and 'GO TO ALL VIEW' is visible. An arrow points to a separate menu box containing: 16 MHz, 18 MHz, 22 MHz, 25 MHz, and OTHER. Text to the right says: 'Rotate the [ENTER] knob to scroll.' and 'OTHER: Private channel'.

2. Rotate the [ENTER] knob to choose appropriate DSC band and then push the [ENTER] knob. One of the menus shown below appears depending on the band selected.

The screenshot shows the 'Compose message' screen with CALL TYPE: 2 MHz. Below it, three options are listed: INTL : T12577.5/R12657.0, LOCAL1 : T12578.0/R12657.5, and LOCAL2 : T12578.5/R12658.0. An arrow points to a separate menu box containing: USER CH1 : T12345.0/R12345.0, USER CH2 : T12345.5/R12345.5, USER CH3 : T12346.0/R12346.0, and USER CH4 : T12346.5/R12346.5. Text to the right says: 'Rotate the [ENTER] knob to scroll menu to view user channels (if registered).' and 'LOCAL = Local channel'.

2MHz menu
INTL :T 2189.5/R 2177.0

8MHz menu
INTL :T 8415.0/R 8436.5
LOCAL :T 8415.5/R8437.0
LOCAL :T 8416.0/R8437.5

18MHz menu
INTL :T18898.5/R19703.5
LOCAL1 :T18899.0/R19704.0
LOCAL2 :T18899.5/R19704.5

4MHz menu
INTL :T 4208.0/R 4219.5
LOCAL1 :T 4208.5/R 4220.0
LOCAL2 :T 4209.0/R 4220.5

12MHz menu
INTL :T 12577.5/R12657.0
LOCAL1 :T 12578.0/R12657.5
LOCAL2 :T 12578.5/R12658.0

22MHz menu
INTL :T 22374.5/R22444.0
LOCAL1 :T 22375.0/R22444.5
LOCAL2 :T 22375.5/R22445.0

6MHz menu
INTL :T 6312.5/R 6331.0
LOCAL1 :T 6313.0/R 6331.5
LOCAL2 :T 6313.5/R 6332.0

16MHz menu
INTL :T 16805.0/R16903.0
LOCAL1 :T 16805.5/R16903.5
LOCAL2 :T 16806.0/R16904.0

25MHz menu
INTL :T 25208.5/R26121.0
LOCAL1 :T 25209.0/R26121.5
LOCAL2 :T 25209.5/R26122.0

Other menu
INTL :T 458.5/R 455.5

3. Rotate the [ENTER] knob to choose DSC frequency and then push the [ENTER] knob. The display shows the DSC frequency band selected, at "DSC FREQ".

Safety or urgency priority

For safety or urgency priority "COM. FREQ" is automatically set to the same pair frequency as the DSC frequency.

1. Rotate the [ENTER] knob to choose DSC FREQ and then push the [ENTER] knob.

The screenshot shows the 'Compose message' screen with the following fields: CALL TYPE: 2187.5, STATION ID: 4207.5, PRIORITY: 6312.0, COM. TYPE: 8414.5, COM. FREQ: 12577.0. At the bottom, 'DSC FREQ' is highlighted, and 'GO TO ALL VIEW' is visible.

2. Rotate the [ENTER] knob to choose appropriate frequency and then push the [ENTER] knob.

5 CALLING, RECEIVING

12. Press the [CALL] key to send the individual call (transmission time: about seven seconds). The display shows the message "Individual request call in progress!" while the call is being sent.

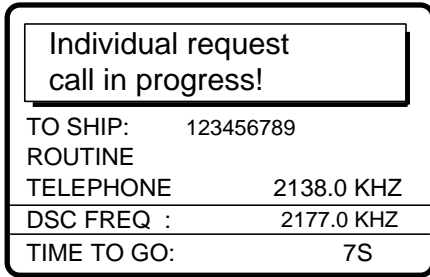

Note: When the channel is in use, "CH BUSY" appears at the lower left-hand side of the screen. Press [CALL] key for forced transmission.

13. After the call is sent, the equipment waits for acknowledgement of the call, showing the display below.

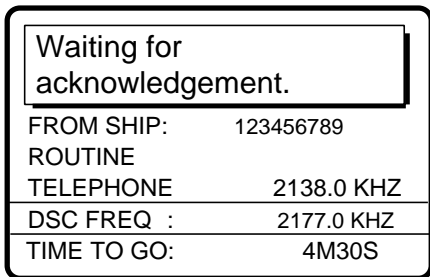

14. The timer starts counting down the maximum time to wait for acknowledgement, five minutes, randomly set. One of the following three messages appears. ("No response! Try calling again." appears after the timer counts down to zero. It means the receiving station did not respond.)

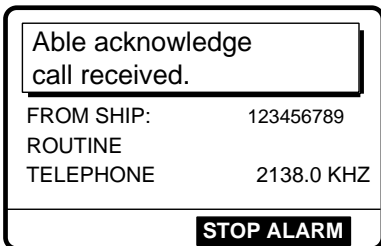

Able acknowledge call received

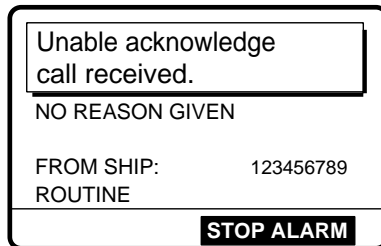

Unable acknowledge call received

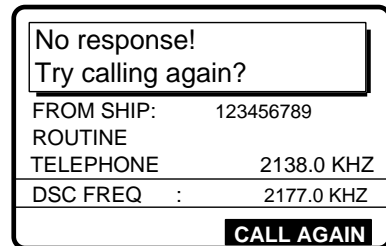

No response from station

15. Do one of the following depending on the message shown in step 14.

Able acknowledge call received**Communicating by radiotelephone**

The audio alarm sounds; press the [CANCEL] key to silence it, and the display changes as below. Press the [CANCEL] key to go to the radiotelephone screen. The working frequency is automatically set; you may start voice communications by radiotelephone.

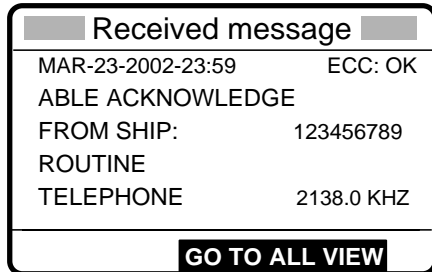
**Sending message by NBDP Terminal Unit**

1. The message "STATION ENTRY COMPLETED FROM DSC. Press any key to escape." appears on the NBDP's display. Press any key on the NBDP Terminal Unit to erase the message.
2. Press the function key [F3] on the keyboard of the NBDP Terminal Unit to show the Operate menu.
3. Choose "Call Station" and then press the [Enter] key.
4. "DSC" is selected; press the [Enter] key. "Connect" appears in reverse video.
5. Type and transmit your message.
6. When you have finished sending your message, press the [F10] key to disconnect the line.

Unable acknowledge call received

The alarm sounds; press the [CANCEL] key to silence the alarm. The display looks something like the one below. Send the call again later. If the coast station sends the message "QUEUE INDICATION," wait until your turn arrives.

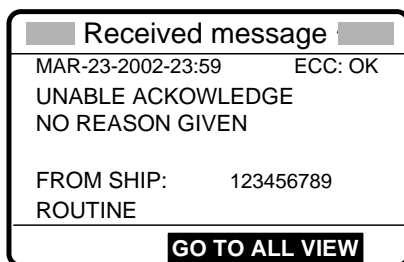

Reason for unable to acknowledge:

NO REASON GIVEN
 CONGESTION AT SWITCHING CENTRE*
 BUSY
 QUEUE INDICATION*
 STATION BARRED*
 NO OPERATOR AVAILABLE*
 OPERATOR TEMPORARILY UNAVAILABLE*
 EQUIPMENT DISABLE
 MODE NOT USABLE
 CHANNEL NOT USABLE

* Coast station use

No response! Try calling again?

Re-send call: Push the [ENTER] knob followed by pressing the [CALL] key.

Cancel call: Press the [CANCEL] key to go to radiotelephone screen.

5.2.2 Receiving an individual call

When own ship receives an individual call, acknowledgement is automatically or manually sent depending on the comply-type setting (see paragraph 7.2). The relationship between comply type and automatic/manual acknowledge is as shown in the table below.

Comply type Setting of [5/ACQ /SQ] key	ABLE	UNABLE
AUTO ACK	Can send acknowledge automatically	Can send UNABLE automatically.
MANUAL ACK	Can send acknowledge manually	Can send UNABLE manually.

Note: The handset must be on hook to enable automatic acknowledge.

Sending automatic acknowledge (ACK BQ) with comply type “ABLE”

1. When an individual call is received and the automatic acknowledge feature is active (AUTO ACK) and the comply type is “ABLE,” the display shown below appears. This display indicates that the auto acknowledge (ACK BQ) call is being sent.

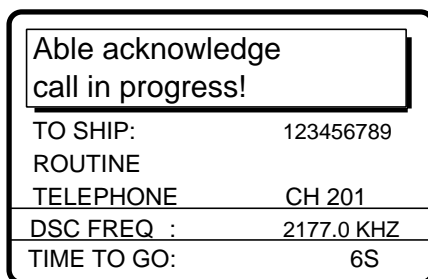

2. It takes about seven seconds to transmit the call, after which the audio alarm sounds and the following message appears.

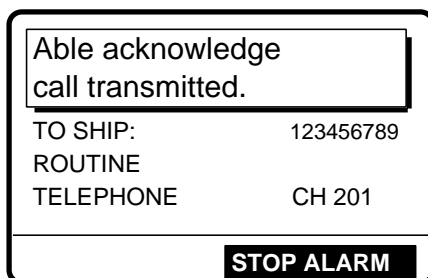

3. Press the [CANCEL] key to silence the alarm. The following display appears.



4. Press the [CANCEL] key. You can now communicate with the party, over the radiotelephone frequency specified or by the NBDP terminal unit.

Communicating by NBDP Terminal Unit

After acknowledging an individual call, do the following to send a message by NBDP Terminal Unit.

1. The control unit's display shows "OCCUPIED" and the TX and RX frequencies.
2. The message from the other station appears on your NBDP Terminal Unit.
3. After receiving the message from other station, type your message and then transmit it.
4. Press the function key [F10] (BREAK) to disconnect the line.

Sending automatic acknowledge (ACK BQ) with comply type "UNABLE"

1. When an individual call is received and the automatic acknowledge feature is active (AUTO ACK) and comply type is "UNABLE," the display shown below appears, indicating that the auto acknowledge call with UNABLE (ACK BQ) is being sent.

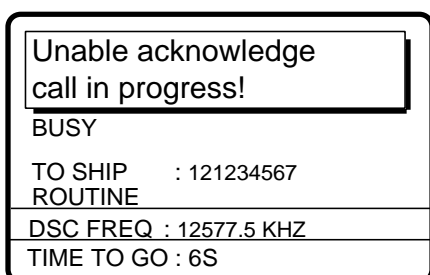

2. It takes about seven seconds to transmit the call, after which the audio alarm sounds and the following message appears.

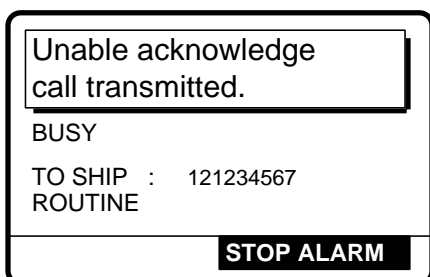

3. Press the [CANCEL] key to silence the alarm. The following display appears.



4. Push the [ENTER] knob to confirm the message. Rotate the [ENTER] knob to scroll the message. Choose GO TO EASY VIEW and then push the [ENTER] knob.

5 CALLING, RECEIVING

5. If you want to send a proposal, rotate the [ENTER] knob to choose RE-SEND and then push the [ENTER] knob.

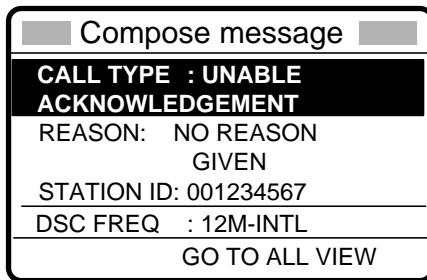

- a) Push the [ENTER] knob to open the CALL TYPE menu.
- b) Rotate the [ENTER] knob to choose ABLE and then push the [ENTER] knob.
- c) Prepare message as appropriate and then press the [CALL] key to transmit the message.
After you receive acknowledgement from the other party you can start communications.

Manually acknowledging individual call with “ABLE”

1. When an individual call is received and the equipment is set up with manual acknowledge (MANUAL ACK) and comply type “ABLE,” the alarm sounds and the display looks like the one below.



2. Press the [CANCEL] key to silence the alarm. The display changes as shown below.



To view contents, rotate [ENTER] knob to choose ALL VIEW and then push [ENTER] knob.

3. Rotate the [ENTER] knob to choose ANSWER and then push the [ENTER] knob. Push the [ENTER] knob again to open the CALL TYPE menu.

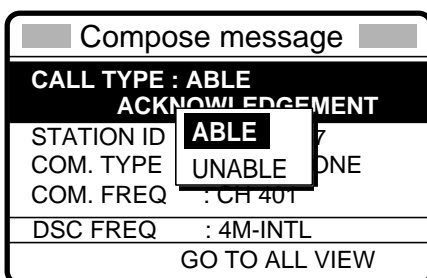

4. Rotate the [ENTER] knob to choose ABLE and then push the [ENTER] knob. The display changes as below. (Working frequency is automatically set as specified by other party.)

Compose message	
CALL TYPE:	ABLE
	ACKNOWLEDGEMENT
STATION ID:	121234567
COM. TYPE:	TELEPHONE
COM. FREQ:	CH401
DSC FREQ:	4M-INTL
GO TO ALL VIEW	

5. Press the [CALL] key to send the call. The display changes as below.

Able acknowledge call in progress!	
TO SHIP	: 121234567
ROUTINE	
TELEPHONE	CH 401
DSC FREQ :	4208.0 KHZ
TIME TO GO:	7S

6. After the call is completely sent (transmission time: 7 sec.), the radiotelephone screen appears (if the communications mode is telephone). You can begin voice communications by radiotelephone. For NBDP operation, do the following:

Communicating by NBDP Terminal Unit

After acknowledging an individual call, do the following to communicate by NBDP Terminal Unit.

1. The control unit's display shows "OCCUPIED" and the TX and RX frequencies.
2. The message from the other party appears on your NBDP Terminal Unit.
3. After receiving the message from the other party, type your message and transmit it.
4. Press the function key [F10] (BREAK) to disconnect the line.

Manually acknowledging individual call with “UNABLE”

1. When an individual call is received and the equipment is set up with manual acknowledge, the alarm sounds and the display shows the message "Individual request call received."



2. Press the [CANCEL] key to silence the alarm. The display changes as below.



To view contents, rotate [ENTER] knob to choose ALL VIEW and push the [ENTER] knob.

3. Rotate the [ENTER] knob to choose ANSWER and then push the [ENTER] knob.
4. Push the [ENTER] knob to open the CALL TYPE menu.

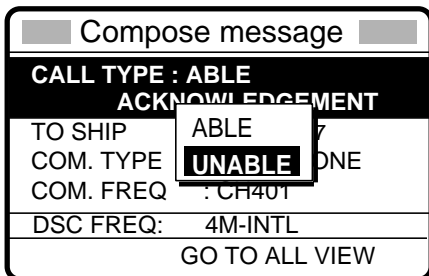

5. Rotate the [ENTER] knob to choose UNABLE and then push the [ENTER] knob.
6. Push the [ENTER] knob to open the REASON menu.

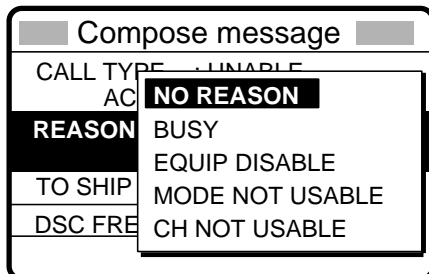

7. Rotate the [ENTER] knob to choose an appropriate reason and then push the [ENTER] knob.

8. The display changes as below.

Compose message	
CALL TYPE	: UNABLE
ACKNOWLEDGEMENT	
REASON	: CHANNEL
	NOT USABLE
STATION ID	: 121234567
DSC FREQ	: 4M-INTL
GO TO ALL VIEW	

9. Press the [CALL] key to send the call. The display shows "Unable acknowledge call in progress!" while the call is being sent.

Unable acknowledge call in progress!	
CHANNEL NOT USABLE	
TO SHIP:	121234567
ROUTINE	
DSC FREQ :	4208.0 KHZ
TIME TO GO:	6S

10. The timer counts down the time remaining until the call is sent (transmission time: about seven seconds). The DSC standby screen appears after the call has been transmitted.

5.3 Group Call

A group call is for calling a specific group by specifying its group ID.

5.3.1 Sending a group call

1. Press the [2/DSC] key and then push the [ENTER] knob to open the CALL TYPE menu.

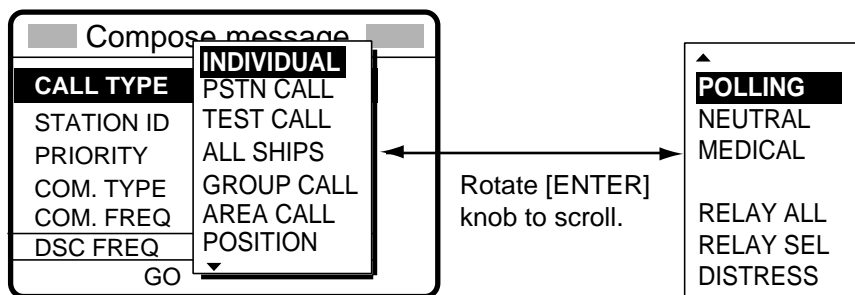

2. Choose GROUP CALL and then push the [ENTER] knob.
 3. Push the [ENTER] knob to open the GROUP ID menu.

Compose message	
CALL TYPE	: GROUP CALL
GROUP ID	000000000
PRIORITY	: ROUTINE
COM. TYPE	: TELEPHONE
COM. FREQ	: NO INFO
DSC FREQ	: 2M-INTL
GO TO ALL VIEW	

4. Key in group ID (nine digits) with the numeric keys and then push the [ENTER] knob.

5 CALLING, RECEIVING

5. Push the [ENTER] knob to open the PRIORITY menu.

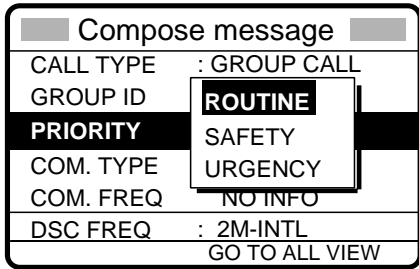

6. Rotate the [ENTER] knob to choose priority desired and then push the [ENTER] knob.

7. Push the [ENTER] knob to open the COM. TYPE menu.

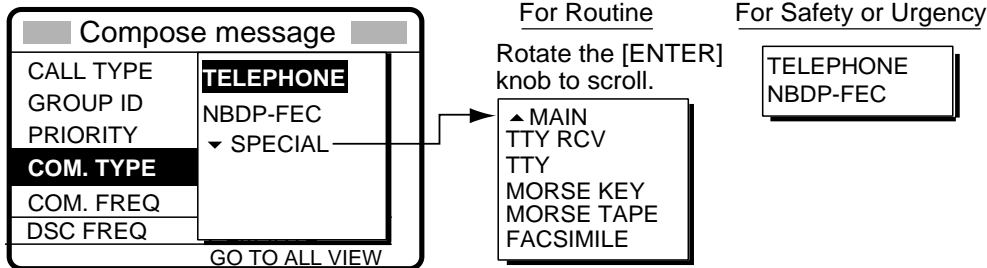

8. Rotate the [ENTER] knob to choose communication type desired and then push the [ENTER] knob.

9. **For routine priority**, push the [ENTER] knob to open the COM. FREQ menu. **For safety or urgency priority**, go to step 11.

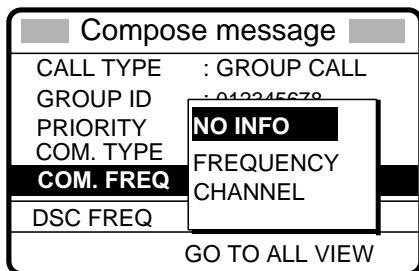

10. Rotate the [ENTER] knob to choose communication frequency desired and then push the [ENTER] knob. (See page 5-6 for details.) NO INFO lets other party choose communication frequency.

11. Push the [ENTER] knob to open the DSC FREQ menu.

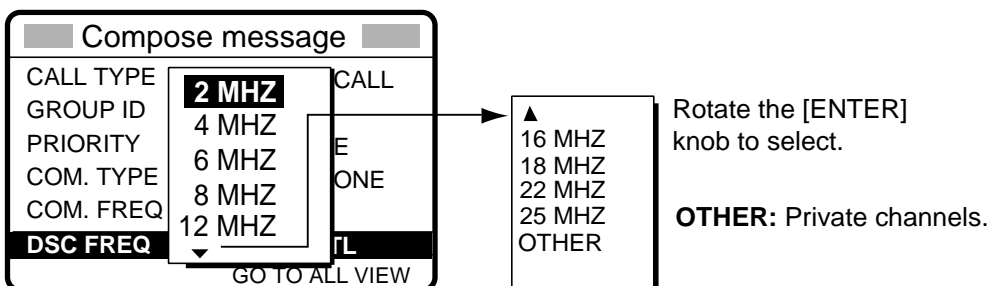

12. Rotate the [ENTER] knob to choose DSC band desired and then push the [ENTER] knob to open the DSC FREQ menu. Rotate the [ENTER] knob to choose DSC frequency desired and then push the [ENTER] knob. (See “How to set DSC frequency” on page 5-7 for details.)

Compose message	
CALL TYPE	: GROUP CALL
GROUP ID	: 012345678
PRIORITY	: ROUTINE
COM. TYPE	: TELEPHONE
COM. FREQ	: 2164.0 KHZ
DSC FREQ	: 2M-INTL
GO TO ALL VIEW	

13. Press the [CALL] key to send the group call (transmission time: about seven seconds). The display shows "Group call in progress!" while the call is being sent.

Group call in progress!	
GROUP ID	: 012345678
ROUTINE	
TELEPHONE	2164.0 KHZ
DSC FREQ	: 2177.0 KHZ
TIME TO GO	: 6S

14. The radiotelephone screen automatically appears after the call is sent, if frequency was specified.
15. If you selected TELEPHONE at step 7, communicate by radiotelephone. For NBDP, do the following:

Sending message by NBDP Terminal Unit

1. The message "STATION ENTRY COMPLETED FROM DSC. Press any key to escape." appears on the NBDP's display. Press any key on the NBDP Terminal Unit to erase the message.
2. Press the function key [F3] on the keyboard of the NBDP Terminal Unit to show the Operate menu.
3. Choose "Call Station" and then press the [Enter] key.
4. "DSC" is selected; press the [Enter] key. "Connect" appears in reverse video.
5. Type and transmit your message.
6. When you have finished sending your message, press the [F10] key to disconnect the line.

5.3.2 Receiving a group call

Group ID must be registered in order to receive a group call. See paragraph 6.2.

1. The audio alarm sounds and the display shows "Group call received" when a group call is received.

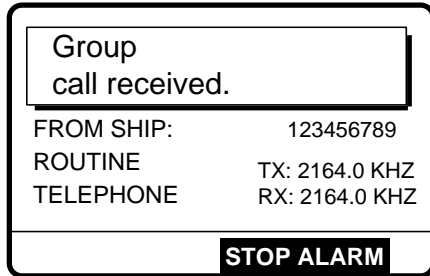

2. Press the [CANCEL] key to silence the alarm, and the display changes as below.

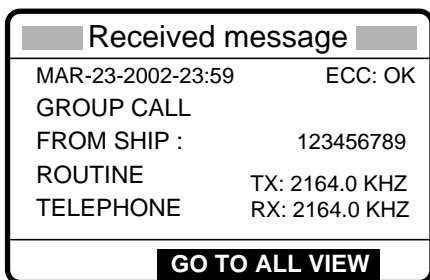

3. Press the [CANCEL] key to go to the radiotelephone screen. Watch on the working frequency.

Receiving message by NBDP Terminal Unit

After receiving a group call, do the following:

1. The controls unit's display shows "OCCUPIED" and the TX and RX frequencies.
2. The message from the sending station appears on your NBDP Terminal Unit.

5.4 Geographical Area Call

The geographical area call is for sending a call to all ships within the area you designate in your geographical area call. In the figure below, for example, the call will be sent to all ships within 24-34°N, 135-140°W.

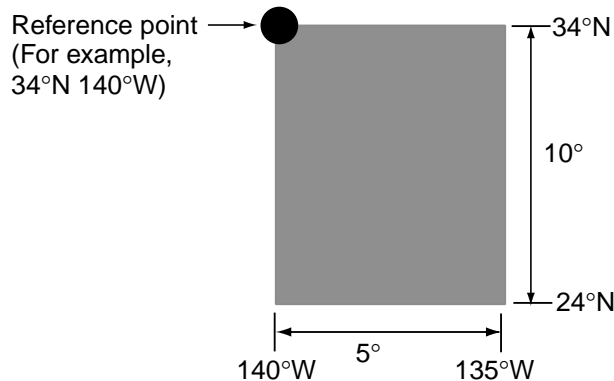

5.4.1 Sending a geographical area call

1. Press the [2/DSC] key and then push the [ENTER] knob to open the CALL TYPE menu.

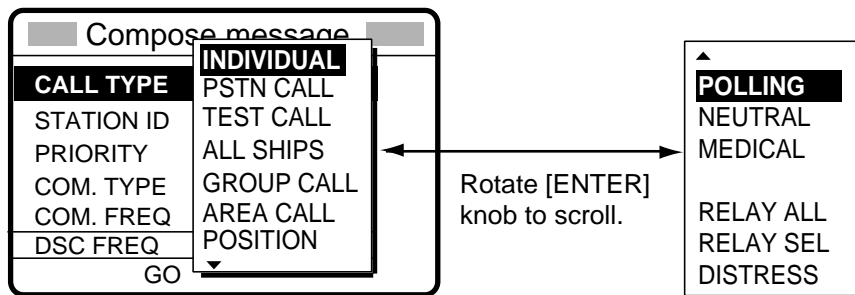

2. Rotate the [ENTER] knob to choose AREA CALL and then push the [ENTER] knob.
3. Push the [ENTER] knob to open the AREA menu.

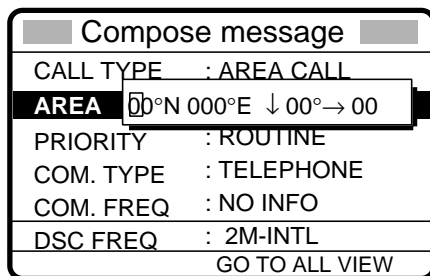

4. Using the numeric keys, enter latitude and longitude of reference point and southerly degrees and easterly degrees of area. To change coordinate, choose it and press the [1] key for North or East; [2] key for South or West. After entering data, push the [ENTER] knob.

5 CALLING, RECEIVING

5. Push the [ENTER] knob to open the PRIORITY menu.

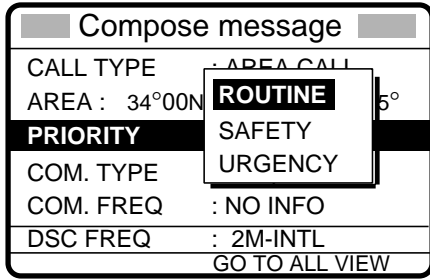

6. Rotate the [ENTER] knob to choose priority desired and then push the [ENTER] knob.
 7. Push the [ENTER] knob to open the COM. TYPE menu.

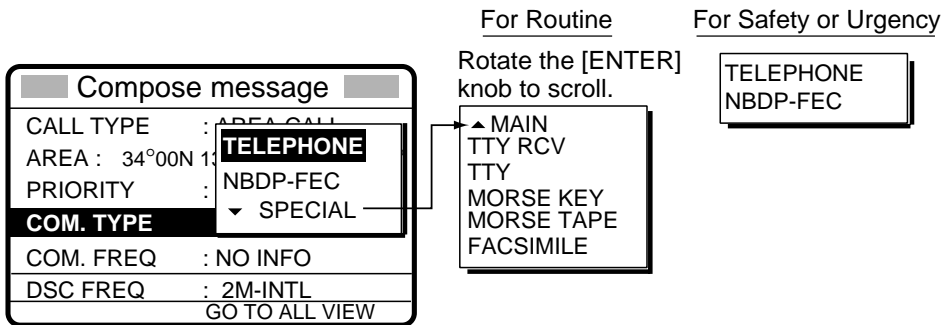

8. Rotate the [ENTER] knob to choose communication type desired and then push the [ENTER] knob.
 9. **For routine priority**, push the [ENTER] knob to open the COM. FREQ menu. **For safety or urgency priority**, go to step 12.

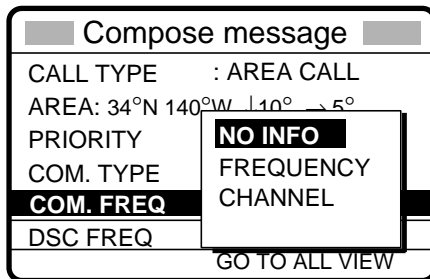

10. Rotate the [ENTER] knob to choose frequency or channel and then enter frequency or channel. (See page 5-6 for details.)
 11. Push the [ENTER] knob to open the DSC FREQ menu.

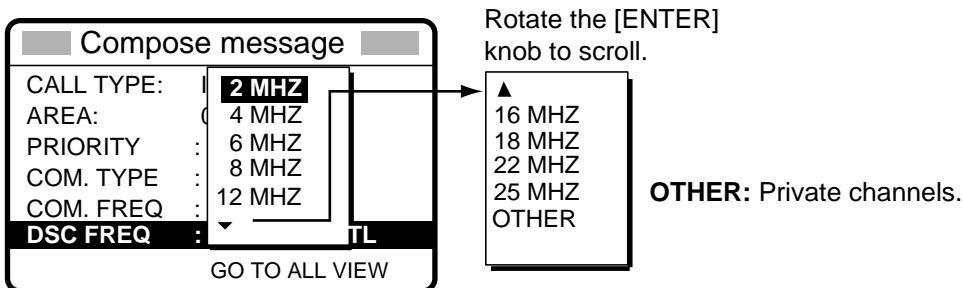

12. Rotate the [ENTER] knob to choose DSC band desired and then push the [ENTER] knob to open the DSC FREQ menu.

13. Rotate the [ENTER] knob to choose DSC frequency desired and then push the [ENTER] knob. (See "How to set DSC frequency" on page 5-7 for details.) Your display should now look something like one below.

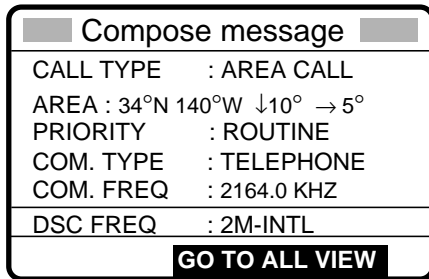

14. Press the [CALL] key to send the geographical area call (transmission time: about seven seconds). The display shows "Geographical area call in progress!" while the call is being sent.

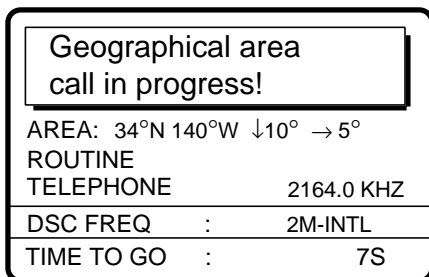

15. After the call is sent the radiotelephone screen appears. If you chose radiotelephone at step 8, you can now communicate with the other party. For NBDP, do the following:

Sending message by NBDP Terminal Unit

1. The message "STATION ENTRY COMPLETED FROM DSC. Press any key to escape." appears on the NBDP's display. Press any key on the NBDP Terminal Unit to erase the message.
2. Press the function key [F3] on the keyboard of the NBDP Terminal Unit to show the Operate menu.
3. Choose "Call Station" and then press the [Enter] key.
4. "DSC" is selected; press the [Enter] key. "Connect" appears in reverse video.
5. Type and transmit your message.
6. When you have finished sending your message, press the [F10] key to disconnect the line.

5.4.2 Receiving a geographical area call

1. The alarm sounds and the display shows "Geographical area call received" when a geographical area call is received.

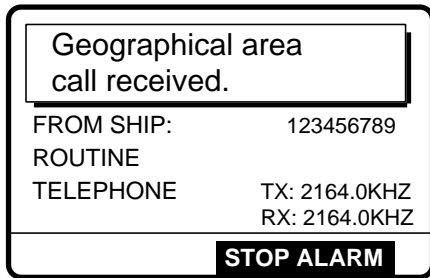

2. Press the [CANCEL] key to silence the alarm. The display changes as below.

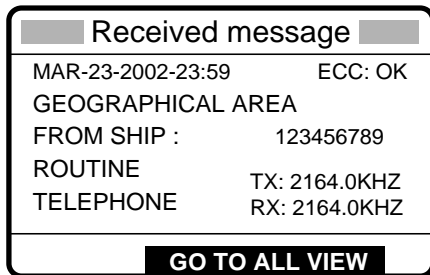

3. Press the [CANCEL] key to go to the radiotelephone screen. Watch on the working frequency specified in the geographic area call.

Receiving message by NBDP Terminal Unit

After receiving a geographic call, do the following to watch by NBDP Terminal Unit:

1. The control unit's display shows "OCCUPIED" and the TX and RX frequencies.
2. The message from the sending station appears on your NBDP Terminal Unit.

5.5 Neutral Craft Call

The neutral craft call, which contains own ship position and ID, informs all ships that your ship is not a participant in armed conflict. Send the call **BEFORE** entering an area of armed conflict.

5.5.1 Sending a neutral craft call

1. Press the [2/DSC] key and then push the [ENTER] knob to display the CALL TYPE menu.

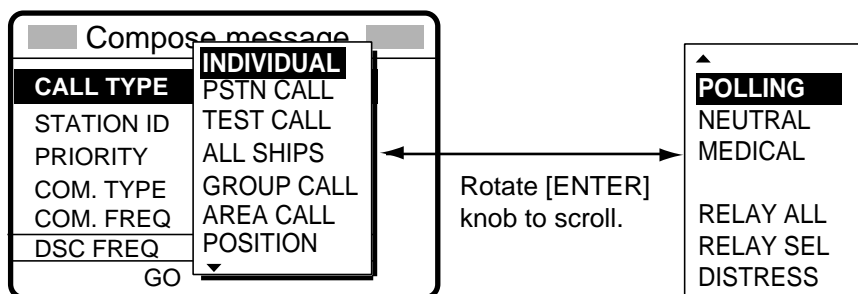

2. Rotate the [ENTER] knob to choose NEUTRAL and then push the [ENTER] knob.
3. Push the [ENTER] knob to open the PRIORITY menu.

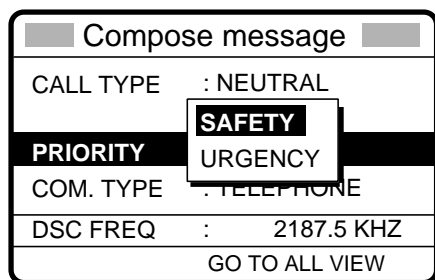

4. Rotate the [ENTER] knob to choose appropriate priority and then push the [ENTER] knob.
5. Push the [ENTER] knob to open the COM. TYPE menu.
6. Rotate the [ENTER] knob to choose communication type desired (radiotelephone or NBDP-FEC) and then push the [ENTER] knob.
7. Push the [ENTER] knob to open the DSC FREQ menu.

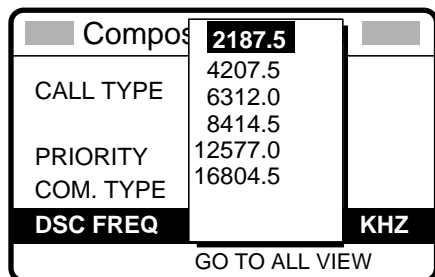

8. Rotate the [ENTER] knob to choose appropriate frequency and then push the [ENTER] knob.

5 CALLING, RECEIVING

Compose message	
CALL TYPE	: NEUTRAL CRAFT
PRIORITY	: SAFETY
COM. TYPE	: TELEPHONE
DSC FREQ	: 2187.5 KHZ
GO TO ALL VIEW	

9. Press the [CALL] key to send the neutral craft call (transmission time: approx. 7 sec.).

Neutral craft call in progress!	
SAFETY	
TELEPHONE	2182.0 KHZ
DSC FREQ :	2187.5 KHZ
TIME TO GO:	7S

10. After the call is sent the radiotelephone screen appears. Inform all ships by radiotelephone that your ship is not a participant in armed conflict.

Sending message by NBDP Terminal Unit

1. The message "STATION ENTRY COMPLETED FROM DSC. Press any key to escape." appears on the NBDP's display. Press any key on the NBDP Terminal Unit to erase the message.
2. Press the function key [F3] on the keyboard of the NBDP Terminal Unit to show the Operate menu.
3. Choose "Call Station" and then press the [Enter] key.
4. "DSC" is selected; press the [Enter] key. "Connect" appears in reverse video.
5. Type and transmit your message.
6. When you have finished sending your message, press the [F10] key to disconnect the line.

5.5.2 Receiving a neutral craft call

1. When a neutral craft call is received the alarm sounds and the display changes as below.

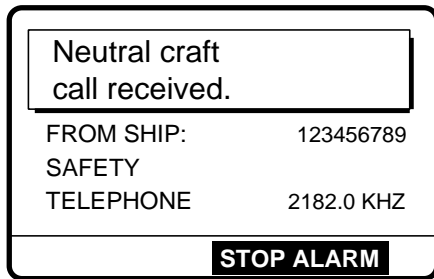

2. Press the [CANCEL] key to silence the alarm. The display changes as below.



3. Press the [CANCEL] key to go to the radiotelephone screen. Watch on the working frequency specified by radiotelephone or NBDP.

Receiving message by NBDP Terminal Unit

After receiving a neutral craft call, do the following to watch by NBDP Terminal Unit.

1. The control unit's display shows "OCCUPIED" and the TX and RX frequencies.
2. The message from the sending station appears on your NBDP Terminal Unit.

5.6 Medical Transport Call

The medical transport call informs all ships, by urgency priority, that own ship carries medical supplies.

5.6.1 Sending a medical transport call

1. Press the [2/DSC] key and then push the [ENTER] knob to open the CALL TYPE menu.

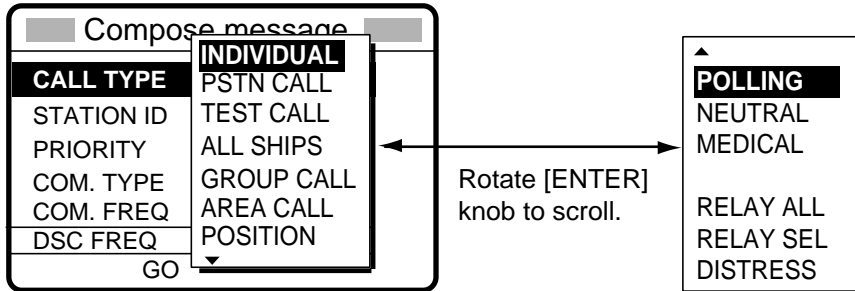

2. Rotate the [ENTER] knob to choose MEDICAL and then push the [ENTER] knob.

Note: PRIORITY is automatically selected to URGENCY.

3. Push the [ENTER] knob to open the COM. TYPE menu.
4. Rotate the [ENTER] knob to choose communication type desired (radiotelephone and NBDP-FEC) and then push the [ENTER] knob.
5. Push the [ENTER] knob to open the DSC FREQ menu.

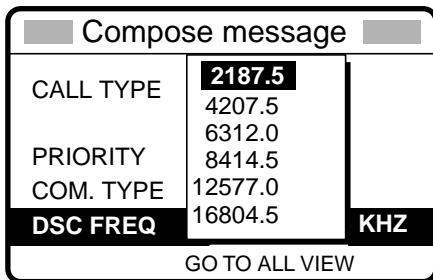

6. Rotate the [ENTER] knob to choose appropriate frequency and then push the [ENTER] knob. The display changes as below.

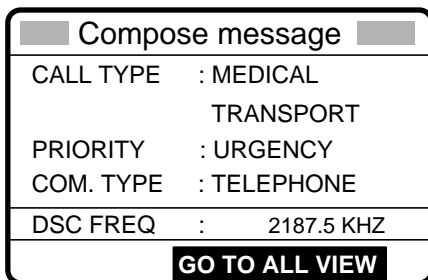

7. Press the [CALL] key to send the call (transmission time: about seven seconds). The display shows "Medical transport call in progress!" while the call is being sent.

Medical transport call in progress!	
URGENCY	
TELEPHONE	2182.0 KHZ
DSC FREQ :	2187.5 KHZ
TIME TO GO :	7S

- After the call is sent the radiotelephone screen automatically appears. Inform all ships (by radiotelephone) that your ship is transporting medical supplies. For NBDP do the following:

Sending message by NBDP Terminal Unit

- The message "STATION ENTRY COMPLETED FROM DSC. Press any key to escape." appears on the NBDP's display. Press any key on the NBDP Terminal Unit to erase the message.
- Press the function key [F3] on the keyboard of the NBDP Terminal Unit to show the Operate menu.
- Choose "Call Station" and then press the [Enter] key.
- "DSC" is selected; press the [Enter] key. "Connect" appears in reverse video.
- Type and transmit your message.
- When you have finished sending your message, press the [F10] key to disconnect the line.

5.6.2 Receiving a medical transport call

- When a medical transport call is received, the alarm sounds and the display looks as below.

Medical transport call received.	
FROM SHIP:	123456789
URGENCY	
TELEPHONE	2182.0 KHZ
STOP ALARM	

- Press the [CANCEL] key to silence the alarm. The display changes as below.

Received message	
MAR-23-2002-23:59	ECC: OK
MEDICAL TRANSPORT	
FROM SHIP:	123456789
URGENCY	
TELEPHONE	2182.0 KHZ
GO TO ALL VIEW	

- Press the [CANCEL] key to go to the radiotelephone screen to watch on frequency specified.

Receiving message by NBDP Terminal Unit

After receiving a neutral craft call, do the following to watch by NBDP Terminal Unit.

1. The display shows "OCCUPIED" and the TX and RX frequencies.
2. The message from the sending station appears on your NBDP Terminal Unit.

5.7 Polling Call

Polling means confirming if own station is within communicating range with other station. This function only provides affirmative or negative response; it does not provide position information. Note that simultaneous polling to more than one station is not possible.

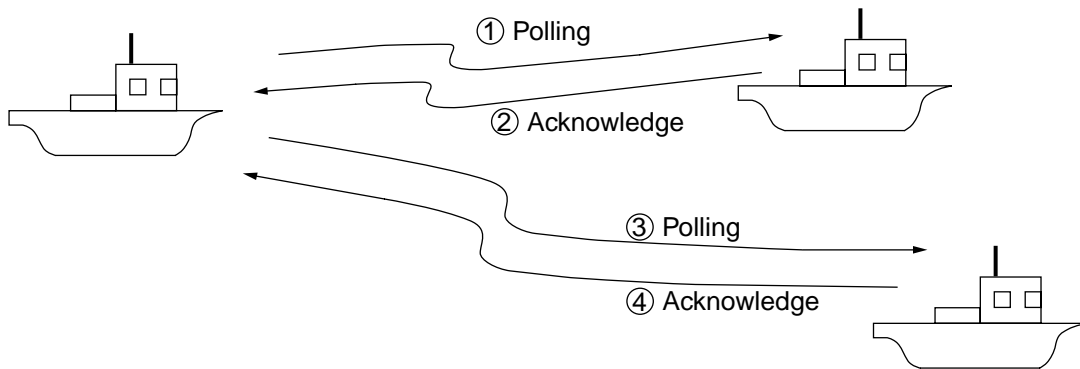

5.7.1 Sending a polling call

1. Press the [2/DSC] key followed by pushing the [ENTER] knob to open the CALL TYPE menu.

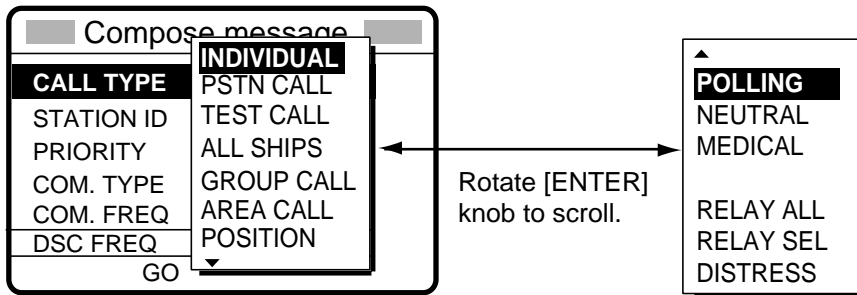

2. Rotate the [ENTER] knob to choose POLLING and then push the [ENTER] knob.
3. Push the [ENTER] knob to open the STATION ID menu.

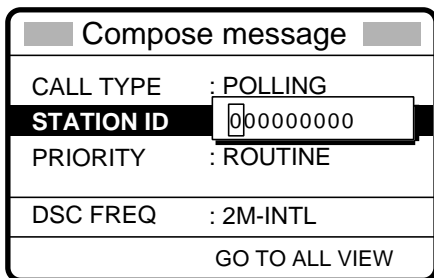

4. Key in ID of station with the numeric keys and then push the [ENTER] knob.
5. Push the [ENTER] knob to open the PRIORITY menu.

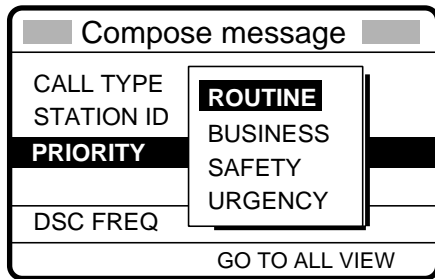

6. Rotate the [ENTER] knob to choose priority desired (usually ROUTINE) and then push the [ENTER] knob.
7. Push the [ENTER] knob to open the DSC FREQ menu.

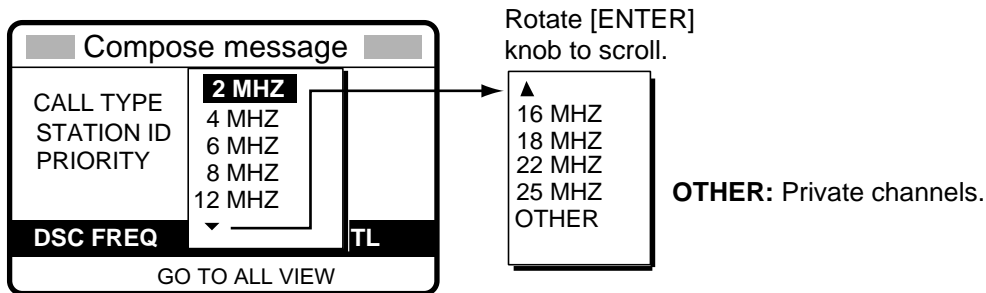

8. Rotate the [ENTER] knob to choose appropriate DSC band and then push the [ENTER] knob. Rotate the [ENTER] knob to choose DSC frequency desired and then push the [ENTER] knob. The display changes as below.

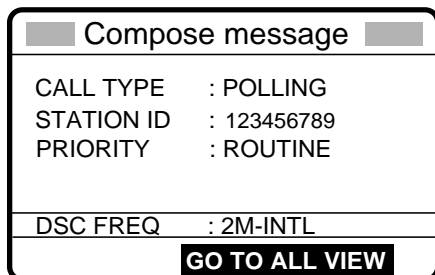

9. Press the [CALL] key to send the call (transmission time: about seven seconds). The display changes as below.

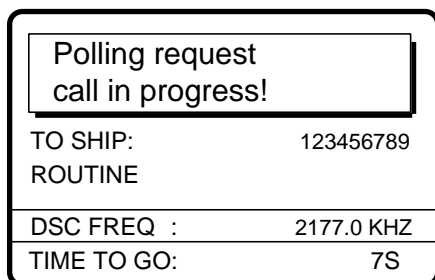

5 CALLING, RECEIVING

10. After the call is sent, the following display appears.

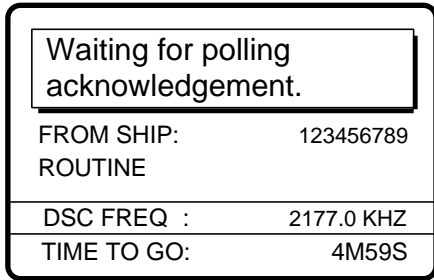

11. The timer counts down the time remaining to wait for acknowledgment of the call. One of the following displays appears. ("No response! Try calling again?" appears when there is no response from receiving station. The timer counts down to zero in this case.)

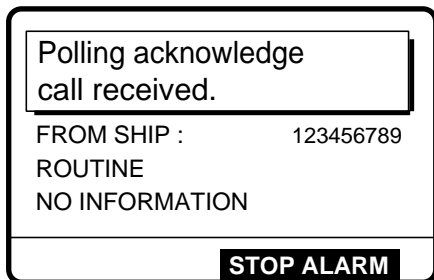

Polling acknowledge call received

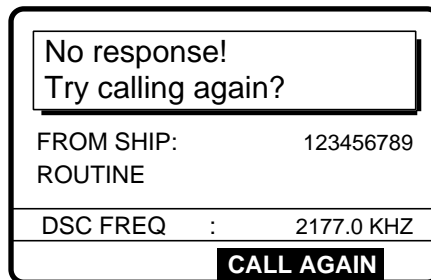

No response

12. Do one of the following depending on the message shown in step 11.

Polling acknowledge call received

The audio alarm sounds; press the [CANCEL] key to silence the alarm. The display changes as below. You can confirm if called party is within communicating range.

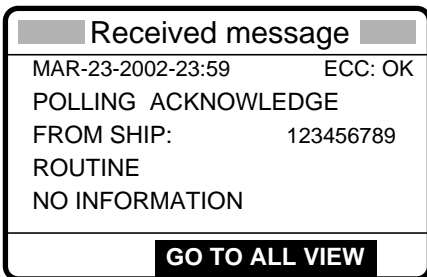

No response! Try calling again?

Re-send call: Push the [ENTER] knob followed by the [CALL] key.

Cancel call: Press the [CANCEL] key to return to the DSC standby screen.

5.7.2 Receiving a polling call

Automatic reply

1. The display changes as shown in the illustration below and the audio alarm sounds when a polling request call is received and the equipment is set up for automatic acknowledge: POLLING on the Auto Ack menu is ON and the [5/ACK/ SQ] key is set to show AUTO ACK on the display. For details see paragraph 7.2.

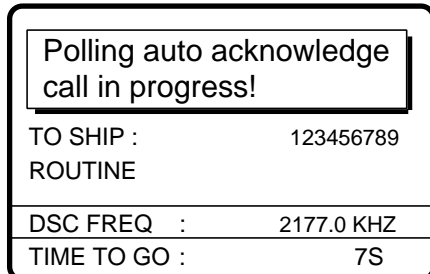

2. After the polling automatic acknowledge call is transmitted, the following display appears and the audio alarm sounds.

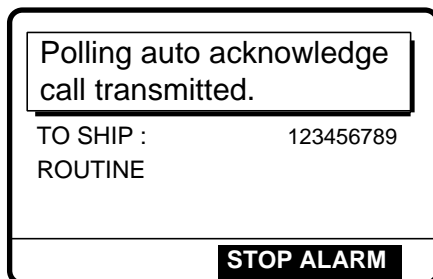

3. Press the [CANCEL] key to silence the alarm. The display changes as below.



4. Press the [CANCEL] key to return to the DSC standby screen.

Manual reply

1. The display changes as shown in the illustration below and the audio alarm sounds when a polling request call is received and the status of the [5/ ACK/SQ] key is MANUAL ACK.



2. Press the [CANCEL] key to silence the alarm. The display changes as below.



3. To respond to the call, rotate the [ENTER] knob to choose ANSWER and then push the [ENTER] knob. The display changes as below.

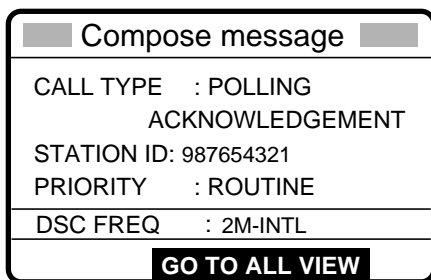

4. Press the [CALL] key to send the polling acknowledge call. The display changes as below.

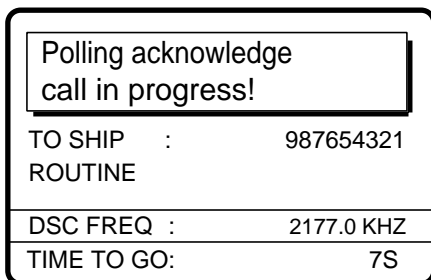

After the call is sent the DSC standby screen appears.

5.8 Position Call

There are two types of position calls: other station requires your ship's position and your ship requests position of another ship.

Finding position of other station

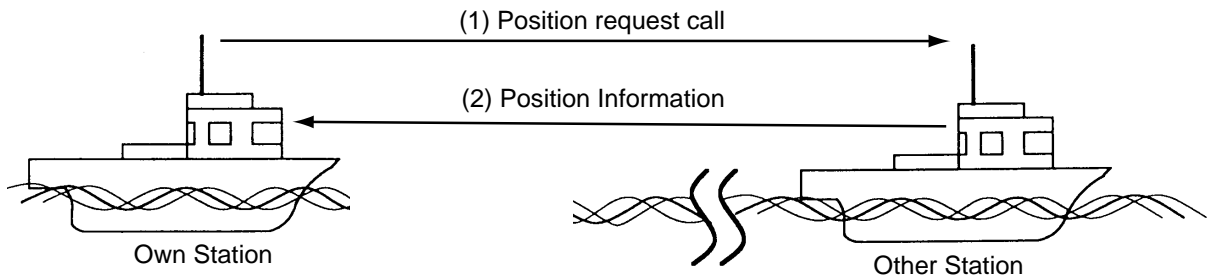

Sending own ship's position to other station

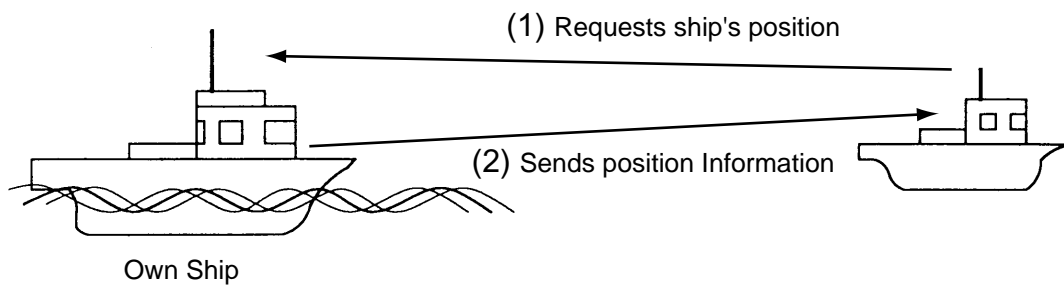

5.8.1 Position call: requesting other ship's position

1. Press the [2/DSC] key and then push the [ENTER] knob to open the CALL TYPE menu.

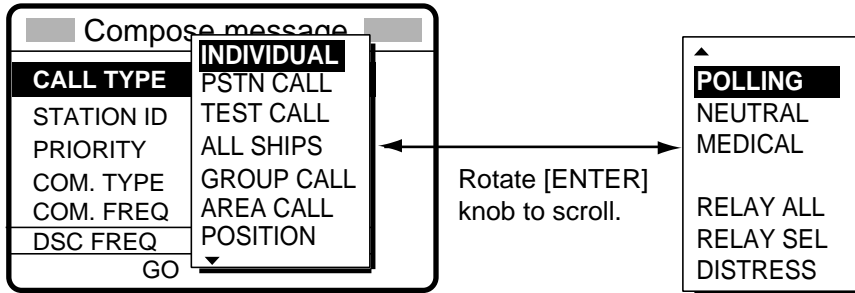

2. Rotate the [ENTER] knob to choose POSITION and then push the [ENTER] knob.
3. Push the [ENTER] knob to open the STATION ID menu.

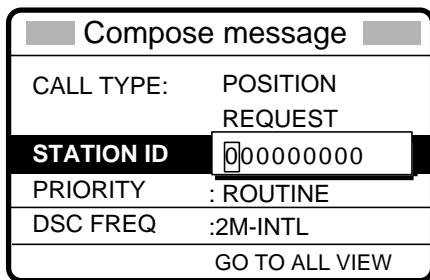

4. Key in ID of station (nine digits) which you want to know its position and then push the [ENTER] knob.
5. Push the [ENTER] knob to open the PRIORITY menu.

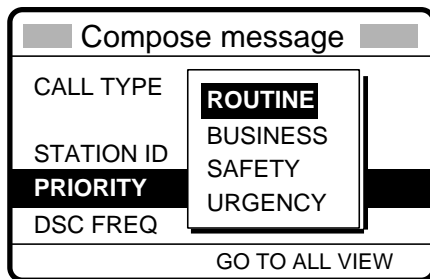

6. Rotate the [ENTER] knob to choose priority desired (usually ROUTINE) and then push the [ENTER] knob.
7. Push the [ENTER] knob to open the DSC FREQ menu.

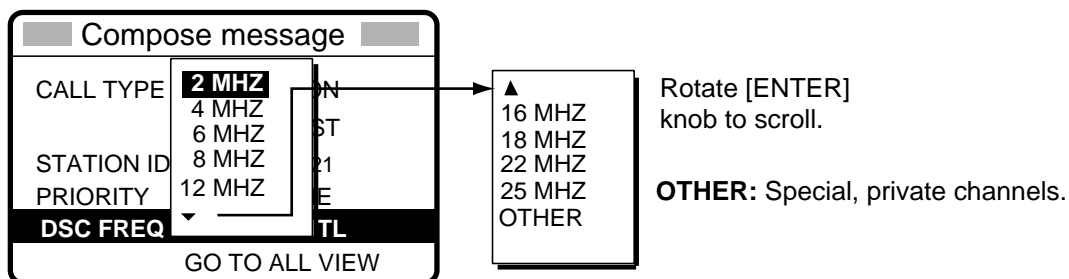

8. Rotate the [ENTER] knob to choose appropriate DSC band and then push the [ENTER] knob. Rotate the [ENTER] knob to choose DSC frequency desired and then push the [ENTER] knob.

9. The display now looks something like the illustration below.

Compose message	
CALL TYPE:	POSITION REQUEST
STATION ID :	123456789
PRIORITY :	ROUTINE
DSC FREQ :	2M-INTL
GO TO ALL VIEW	

10. Press the [CALL] key to send the call (transmission time: about seven seconds). The following display appears.

Position request call in progress!	
TO SHIP :	123456789
ROUTINE	
DSC FREQ :	2177.0 KHZ
TIME TO GO:	7S

11. After the call has been sent, the following display appears.

Waiting for pos acknowledgment.	
FROM SHIP :	123456789
ROUTINE	
DSC FREQ :	2177.0 KHZ
TIME TO GO:	4M30S

12. One of the following messages appears. (“No response! Try calling again?” appears after the time has counted down to zero, meaning there was no response from the party called.)

Pos acknowledge call received.	
FROM SHIP :	123456789
ROUTINE	
POS :	12°34N 123°45E AT 12:34
STOP ALARM	

Position acknowledge call received

No response! Try calling again?	
FROM SHIP :	123456789
ROUTINE	
DSC FREQ :	2177.0 KHZ
CALL AGAIN	

No response

13. Do one of the following depending on the message displayed at step 12.

Acknowledge call received

The audio alarm sounds; press the [CANCEL] key to silence the alarm. The display looks as below. You can now confirm position of other ship.

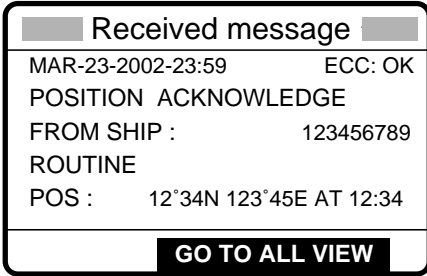

No response! Try calling again?

Re-send call: Push the [ENTER] knob followed by the [CALL] key.

Cancel call: Press the [CANCEL] key.

5.8.2 Position call: other ship requests your position

You may turn automatic acknowledge of position request on or off with POSITION CALL in the AUTO ACK menu. For further details, see page 8-3.

Automatic reply

1. When another ship requests your position and the status of the [5/ ACK/SQ] key is AUTO ACK and the setting of POSITION CALL on the Auto ack menu is ON, the FS-1570/2570 transmits own position data (transmission time: approx. 7 sec.), showing the display below.

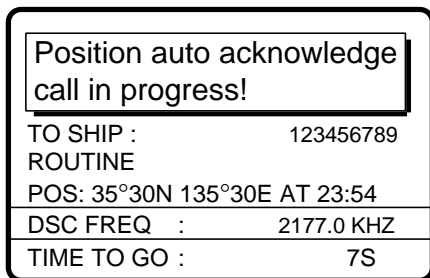

2. After the call is sent the audio alarm sounds and the display below appears.

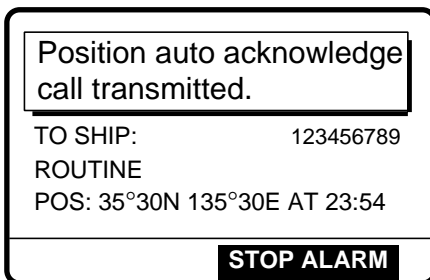

3. Press the [CANCEL] key to silence the alarm, and the display changes as below.

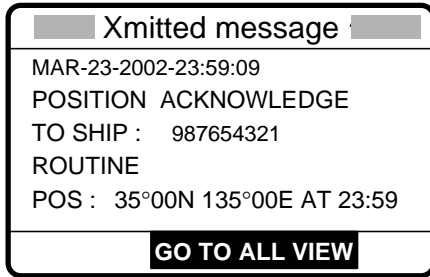

4. Press the [CANCEL] key to return to the DSC standby screen.

Manual reply

1. When a position request call is received and the status of the [5/ ACK/SQ] key is MANUAL ACK, the audio alarm sounds and the display changes as below.



2. Press the [CANCEL] key to silence the alarm. The display changes as below.



3. To send your ship's position, rotate the [ENTER] knob to choose ANSWER and then push the [ENTER] knob. Your display should now look something like the one below.

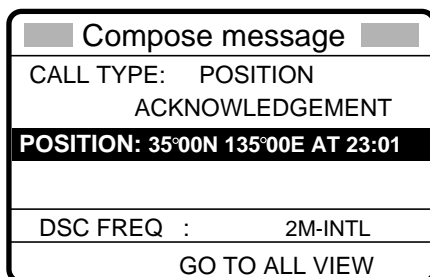

5 CALLING, RECEIVING

4. Confirm the position shown and then press the [CALL] to send the position data call (transmission time: approx. 7 sec.). The display changes as below.

Pos acknowledge call in progress!	
TO SHIP :	123456789
ROUTINE	
POS: 35°00N 135°00E AT 23:01	
DSC FREQ :	2177.0 KHZ
TIME TO GO:	7S

5. The DSC standby screen automatically appears after the call is sent.

5.9 PSTN Call

The PSTN call allows the making and receiving of telephone calls over public switched telephone networks. To use the PSTN call feature, use a handset which has a HOOK ON/OFF function. The standard supply handset has this feature.

5.9.1 Sending a PSTN call, receiving acknowledge back (ACK BQ)

1. Press the [2/DSC] key and then push the [ENTER] knob to open the CALL TYPE menu.

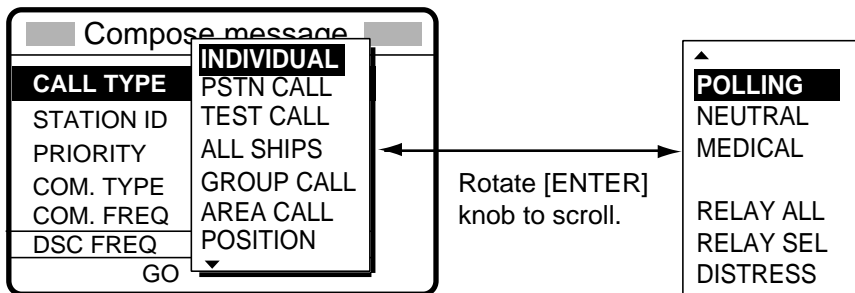

2. Rotate the [ENTER] knob to choose PSTN CALL and then push the [ENTER] knob.
3. Push the [ENTER] knob to open the COAST ID menu.

Compose message	
CALL TYPE:	PSTN CALL
COAST ID	0000000
TEL NO. :	
DSC FREQ	:12M-INTL
GO TO ALL VIEW	

4. Key in ID of coast station (seven digits) with the numeric keys and then push the [ENTER] knob.

5. Push the [ENTER] knob to open the TEL NO. menu.

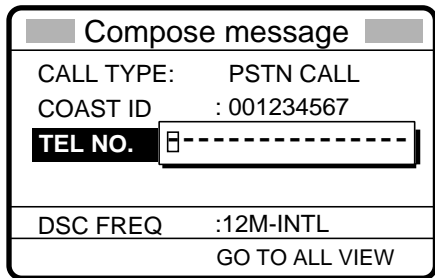

6. Enter telephone no. (up to 16 digits) with the numeric keys and then push the [ENTER] knob.
7. Push the [ENTER] knob to open the DSC FREQ menu.

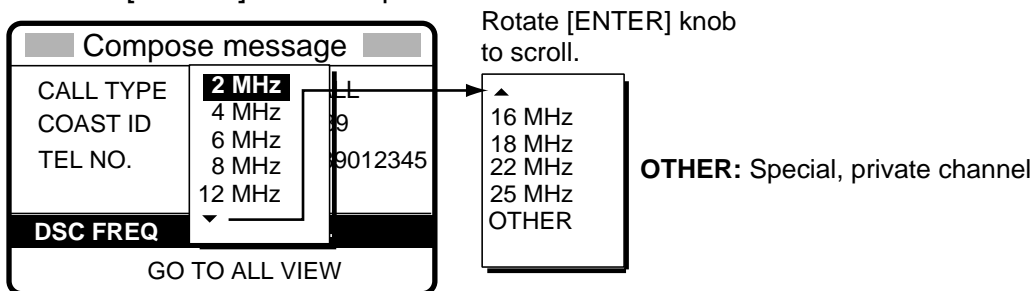

8. Rotate the [ENTER] knob to choose DSC band desired and then push the [ENTER] knob to open the DSC FREQ menu. Rotate the [ENTER] knob to choose DSC frequency desired and then push the [ENTER] knob. The display changes as below.

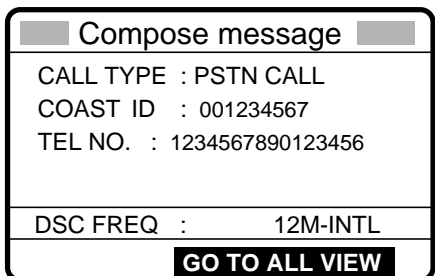

9. Press the [CALL] key to send the PSTN call (transmission time: about seven seconds). The display shows the following message.

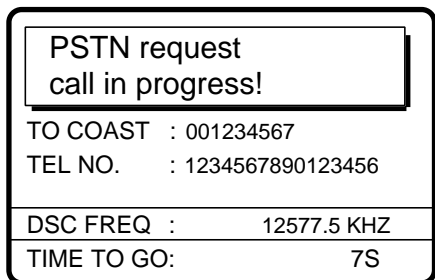

10. One of the following three displays appears. ("No response. Try calling again." Appears after timer counts down to zero and it means there was no response from the coast station.)

5 CALLING, RECEIVING

Waiting for acknowledgement.	
FROM COAST :	001234567
TEL NO. :	1234567890123456
DSC FREQ :	12577.5 KHZ
TIME TO GO:	25S

Unable acknowledge call received.	
BUSY	
FROM COAST :	001234567
TEL NO. :	1234567890123456
STOP ALARM	

No response! Try calling again?	
FROM COAST :	001234567
TEL NO. :	1234567890123456
DSC FREQ :	12577.5 KHZ
RE-SEND	

11. Do one of the following depending on the message shown at step 10.

Waiting for acknowledgement

- 1) If the PSTN call is accepted, the PSTN connection call is sent (transmission time: about seven seconds), showing the display below.

PSTN connection call in progress!	
TO COAST :	001234567
TEL NO. :	1234567890123456
DSC FREQ :	12577.0 KHZ
TIME TO GO:	7S

- 2) After the call is sent the following messages appears.

Waiting for acknowledgement.	
FROM COAST :	001234567
TEL NO. :	1234567890123456
DSC FREQ :	12577.5 KHZ
TIME TO GO:	25S

- 3) Then, one of the following displays appears.

PSTN call connected.	
TO COAST :	001234567
TEL NO. :	1234567890123456
DSC FREQ :	12577.5 KHZ

PSTN call connected

PSTN end of call in progress!	
TO COAST :	001234567
TEL NO. :	1234567890123456
DSC FREQ :	12577.5 KHZ
TIME TO GO:	8S

PSTN end of call

- 4) Follow the instructions below depending on the message shown in 3) above.

PSTN call connected: Your phone rings; pick up the handset and communicate with the party you called.

PSTN end of call in progress: This means channel could not be used. After the timer counts down to zero repeat this procedure to re-send the call.

Unable acknowledge call received

- 1) The audio alarm sounds; press the [CANCEL] key or [ENTER] knob to silence the alarm.
The display shown below appears.

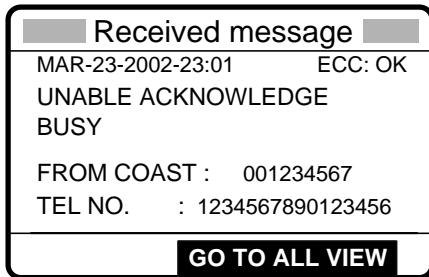

- 2) Press the [CANCEL] key to return to the DSC standby screen. Try the call again later.

No response! Try calling again?

Re-send call: Push the [ENTER] knob followed by the [CALL] key.

Cancel call: Press the [CANCEL] key to return to the DSC standby screen.

5.9.2 Receiving a PSTN call, sending acknowledge back (ACK BQ)

1. The following display appears when a PSTN call is received when automatic acknowledge is turned on.

Able acknowledge call in progress!	
TO COAST :	001234567
TEL NO. :	1234567890123456
DSC FREQ :	4208.0 KHZ
TIME TO GO:	8S

2. The timer counts down to zero and then the following display appears.

Pick up the handset or press CALL key.	
FROM COAST :	001234567
TEL NO. :	1234567890123456
DSC FREQ :	4208.0 KHZ
TIME TO GO:	60S

3. Pick up the handset or press the [CALL] key within one minute.

PSTN connection call in progress!	
TO COAST :	001234567
TEL NO. :	1234567890123456
DSC FREQ :	4208.0 KHZ
TIME TO GO:	7S

4. When the timer counts down to zero the following message appears.

Waiting for acknowledgement.	
FROM COAST :	001234567
TEL NO. :	1234567890123456
DSC FREQ :	4208.0 KHZ
TIME TO GO:	25S

5. Shortly thereafter, one of the following messages appears.

PSTN call connected.	
TO COAST :	001234567
TEL NO. :	1234567890123456
DSC FREQ :	4208.0KHZ

PSTN call connected

PSTN connection call in progress!	
FROM COAST :	001234567
TEL NO. :	1234567890123456
DSC FREQ :	4208.0KHZ
TIME TO GO:	25S

PSTN connection call in progress

PSTN end of call in progress!	
TO COAST :	001234567
TEL NO. :	1234567890123456
DSC FREQ :	4208.0KHZ
TIME TO GO:	7S

PSTN end of call

6. Do one of the following depending on the message shown at step 5.

PSTN call connected: Your phone rings; communicate with party.

PSTN connection call in progress!: If the channel assigned is appropriate, the message "Waiting for acknowledgment." appears. (If the channel cannot be used the message "PSTN end of call in progress!" appears. In this case, start this procedure again.)

PSTN end of call in progress!: The channel could not be used. Press the [CANCEL] key to return to the DSC standby screen.

5.9.3 PSTN call disconnection, receiving charge information (ship disconnects line)

1. After hanging up the handset or pressing the [CANCEL] key to complete your call, the display shows the following message.

PSTN end of call in progress!	
TO COAST :	001234567
TEL NO. :	1234567890123456
DSC FREQ :	12577.5 KHZ
TIME TO GO:	8S

2. After the call is sent, the following messages appears.

Waiting for charge information.	
FROM COAST :	001234567
TEL NO. :	1234567890123456
DSC FREQ :	12577.5 KHZ
TIME TO GO:	20S

3. When the timer counts down to zero one of the following displays appear.

Charge information call received.	
CHARGE TIME :	00H 12M 34S
FROM COAST :	001234567
TEL NO. :	1234567890123456
STOP ALARM	

No response! charge information.	
FROM COAST :	001234567
TEL NO. :	1234567890123456

4. For “No response! charge information.”, the equipment reverts to step 2 in this procedure to await charge information. For “Charge information call received.”, the audio alarm sounds; press the [CANCEL] key or [ENTER] knob to silence the audio alarm. The display shown below appears.



5.9.4 PSTN call disconnection, receiving charge information (coast station disconnects line)

1. The PSTN line is disconnected by the coast station when it finds no evidence of communications or the land subscriber hangs up. The coast station then sends charge information as below.



2. For no charge information the display looks as below.



5.10 Log File

Three log files are provided for storage of calls: received ordinary log, received distress log and transmitted log. Each log file stores 50 calls, on a first-in, first-out basis. This means that the latest call is saved as log no.1 and the log no. of all previous calls in that log increments by one. When the storage capacity is exceeded, the oldest call is deleted to make room for the latest. An asterisk (*) marks unread or unacknowledged calls. Received distress calls are automatically deleted 48 hours after being read.

5.10.1 Opening a log file

The procedure for opening a log is common to all logs. The example below shows how to open the received distress log.

1. At the DSC standby screen, press the [LOG/TUNE] key to open the Log file menu.

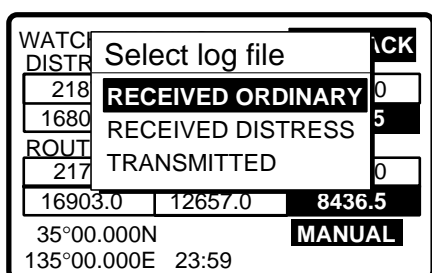

2. Rotate the [ENTER] knob to choose desired log and push the [ENTER] knob. For example, choose the RECEIVED DISTRESS log and then push the [ENTER] knob. Rotate the [ENTER] knob to scroll the log. Asterisk indicates unread message.

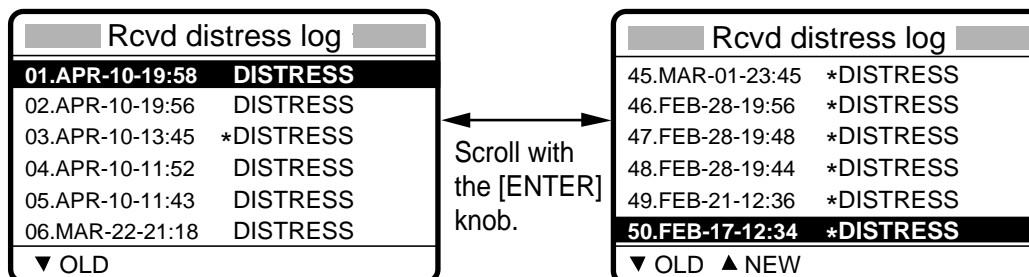

3. To view the contents of a file, do the following:

- a) Rotate the [ENTER] knob to choose the file desired and then push the [ENTER] knob.



- b) DETAIL is selected; push the [ENTER] knob.



5 CALLING, RECEIVING

4. **To scroll the log up and down**, use the [FILE/CURSOR] and [#/SETUP] keys, respectively. Use [FILE/CURSOR] key to scroll forward; the [#/SETUP] to scroll backward.
5. **To print all files in the log selected**, press the [8/PRINT] key.
6. **To reply to an unanswered call**, rotate the [ENTER] knob to choose ANSWER, press the [ENTER] knob, and then press the [CALL] key.
7. **To return to the log selected**, press the [CANCEL] key.

Deleting files

1. Do steps 1-2 and 3a) in the previous procedure to choose the file you wish to delete.
2. Rotate the [ENTER] knob to choose DELETE and then press the [ENTER] knob.

The log files are renumbered to reflect the deletion. Unread files cannot be deleted.

5.11 Erasing Message Files

The Erase file menu allows you to erase the entire contents of the received ordinary log, received distress log, transmitted log and send message log.

1. At the DSC standby screen, press the [#/SETUP] key.
2. Rotate the [ENTER] knob to choose ERASE and then push the [ENTER] knob to display the Erase file menu.
3. Rotate the [ENTER] knob to choose the item to erase and then push the [ENTER] knob.
4. Rotate the [ENTER] knob to choose YES and then push the [ENTER] knob.

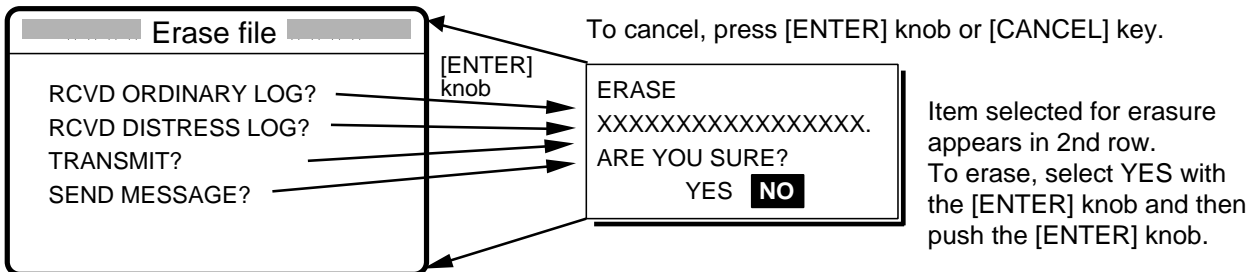

6 PREPARING TX CALLS

In Chapter 5 you learned how to prepare and send various types of DSC calls. In this chapter you will learn how to prepare and store individual, PSTN, group, area and test calls for future transmission. 150 calls can be stored.

6.1 Preparing Individual Calls

1. At the DSC standby screen, press the [#/SETUP] key to open the Setup menu.

Setup menu	
ALARM	SCAN FREQ
AUTO ACK	
ERASE	VOLUME
MESSAGE	
POSITION	TEST
PRINT OUT	SYSTEM

2. Rotate the [ENTER] knob to choose MESSAGE and then push the [ENTER] knob.
3. Push the [ENTER] knob to open the CALL TYPE menu.

Message file entry	
CALL TYPE	INDIVIDUAL
STATION ID	PSTN CALL
COM. TYPE	GROUP CALL
COM. FREQ	AREA CALL
DSC FREQ	TEST CALL
▼	

4. Rotate the [ENTER] knob to choose INDIVIDUAL and then push the [ENTER] knob.
5. Push the [ENTER] knob to open the STATION ID entry window.

Message file entry	
CALL TYPE	: INDIVIDUAL
STATION ID	00000000
COM. TYPE	: TELEPHONE
COM. FREQ	: NO INFO
DSC FREQ	: 2M-INTL
▼	

6. Key in ID of coast station or ship station with the numeric keys and then push the [ENTER] knob.

6 PREPARING TX CALLS

7. Push the [ENTER] knob to open the COM. TYPE window.

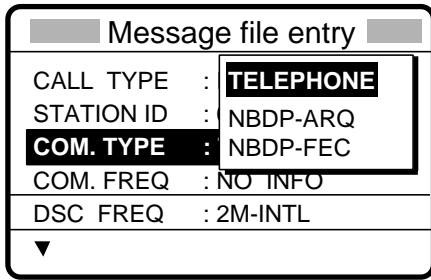

8. Rotate the [ENTER] knob to choose communication type desired and then push the [ENTER] knob.

9. Push the [ENTER] knob to open the COM. FREQ window.

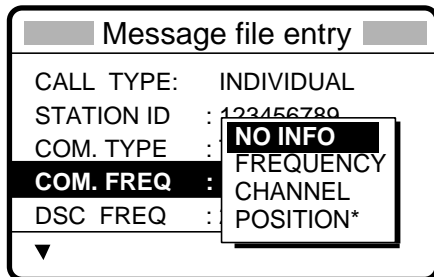

* POSITION appears when coast station ID is entered in the field STATION ID.

10. Rotate the [ENTER] knob to choose appropriate item and then push the [ENTER] knob.

Call to coast station: NO INFO or POSITION.

Call to ship station: FREQUENCY or CHANNEL. Enter appropriate frequency or channel, referring to page 5-6.

11. Push the [ENTER] knob to open the DSC FREQ menu.

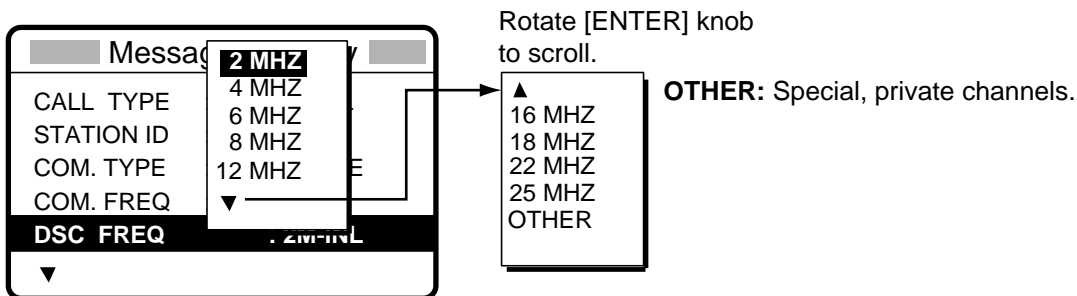

12. Rotate the [ENTER] knob to choose appropriate DSC band and then push the [ENTER] knob.

13. Rotate the [ENTER] knob to choose appropriate DSC frequency and then push the [ENTER] knob.

14. Enter file name and number as shown on the next page.

How to Enter File Name and Number

1. Push the [ENTER] knob to open the file name entry window.

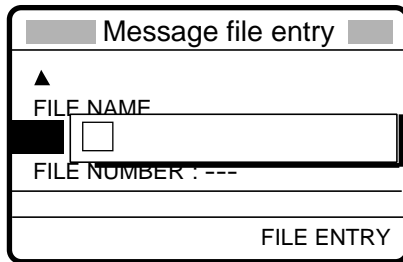

2. Use the numeric keys and [ENTER] knob to enter file name (max. 16 characters).
For example, enter FURUNO as the file name. Push the [ENTER] knob after entering.

Key and available character, symbol

[1] : 1→(blank)→1
 [2ABC] : 2→A→B→C→2
 [3DEF] : 3→D→E→F→3
 [4GHI] : 4→G→H→I→4
 [5JKL] : 5→J→K→L→5
 [6MNO] : 6→M→N→O→6
 [7PQRS] : 7→P→Q→R→S→7
 [8TUV] : 8→T→U→V→8
 [9WXYZ] : 9→W→X→Y→Z→9
 [0] : 0→_→-→0

1. Rotate [ENTER] knob to select location.
2. Press appropriate key.

How to enter "FURUNO" as file name

1. Press the [3] key to display F.
2. Rotate [ENTER] knob to shift cursor.
3. Press the [8] key to select U.
4. Rotate [ENTER] knob to shift cursor.
5. Press the [7] key to select R.
6. Rotate [ENTER] knob to shift cursor.
7. Press the [8] key to select U.
8. Rotate [ENTER] knob to shift cursor.
9. Press the [6] key to select N.
10. Rotate [ENTER] knob to shift cursor.
11. Press the [6] key to select O.
12. Push the [ENTER] knob.

3. Push the [ENTER] knob to open the file number entry window. Key in file number in three digits with the numeric keys and then push the [ENTER] knob. For example, press [0], [0], [1], [ENTER] knob to enter file number 001.

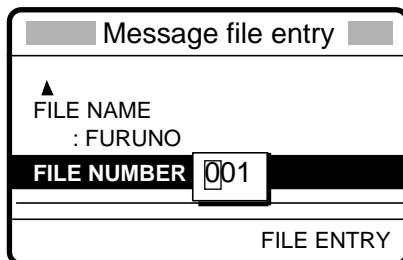

Note: The available file number is 001-799 and 900-999.

4. Push the [ENTER] knob. The display shows the name and file number entered.

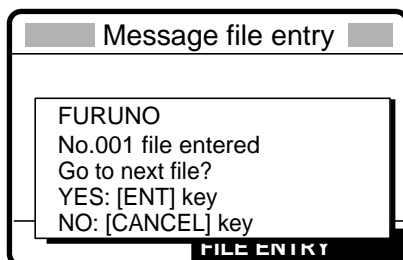

If the file name or number exists the message "Duplicate name (number) ! Overwrite OK?" appears. Push the [ENTER] knob to write over the name, or press the [CANCEL] key to escape.

5. Push the [ENTER] knob to continue.

6.2 Preparing Group Calls

1. At the DSC standby screen, press the [# / SETUP] key to open the Setup menu.

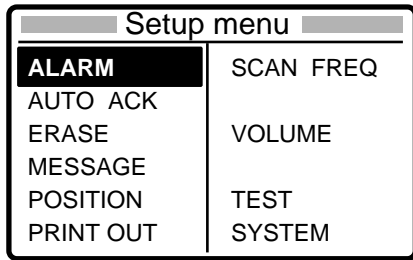

2. Rotate the [ENTER] knob to choose MESSAGE and then push the [ENTER] knob.
3. Push the [ENTER] knob to open the CALL TYPE menu.

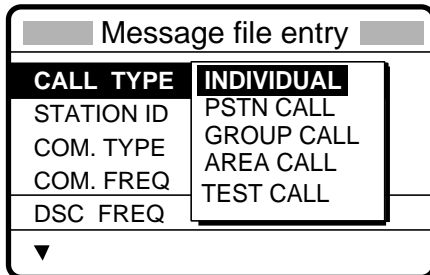

4. Rotate the [ENTER] knob choose GROUP CALL and then push the [ENTER] knob.
5. Push the [ENTER] knob to open the GROUP ID entry window.

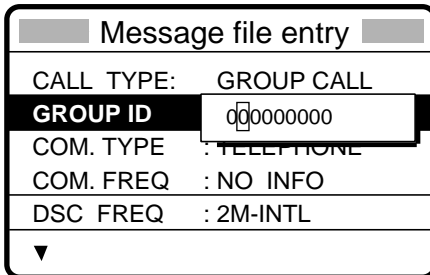

6. Key in ID of group with the numeric keys and then push the [ENTER] knob.
7. Push the [ENTER] knob to open the COM. TYPE menu.

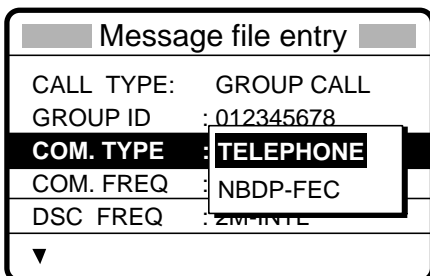

8. Rotate the [ENTER] knob to choose appropriate communications type and then push the [ENTER] knob.
9. Push the [ENTER] knob to open the COM. FREQ menu.

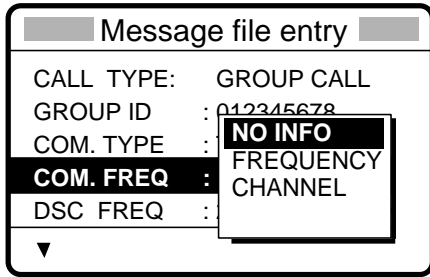

10. Rotate the [ENTER] knob to choose appropriate item and then push the [ENTER] knob. Enter frequency or channel. (See page 5-6 for details for how to enter frequency and channel.)
11. Push the [ENTER] knob to open the DSC FREQ menu.

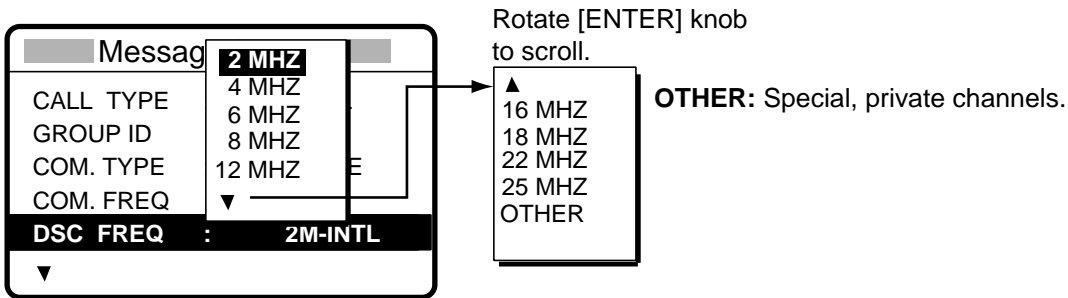

12. Rotate the [ENTER] knob to choose appropriate DSC band and then push the [ENTER] knob. Choose appropriate DSC frequency and then push the [ENTER] knob.
13. Follow "How to Enter File Name and Number" on page 6-3 to enter file name and number.

6.3 Preparing Geographical Area Calls

1. At the DSC standby screen, press the [# / SETUP] key to open the Setup menu.
2. Rotate the [ENTER] knob to choose MESSAGE and then push the [ENTER] knob.
3. Push the [ENTER] knob to open the CALL TYPE menu.

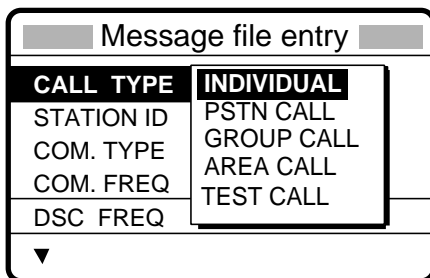

4. Rotate the [ENTER] knob to choose AREA CALL and then push the [ENTER] knob.
5. Push the [ENTER] knob to open the AREA entry window.

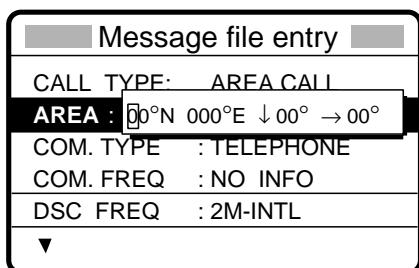

6 PREPARING TX CALLS

6. Using the numeric keys, enter latitude and longitude of reference point and southerly degrees and easterly degrees of area. To change coordinate, choose it and press the [1] key for North or East; [2] key for South or West. After entering data, push the [ENTER] knob.
7. Push the [ENTER] knob to open the COM. TYPE menu.

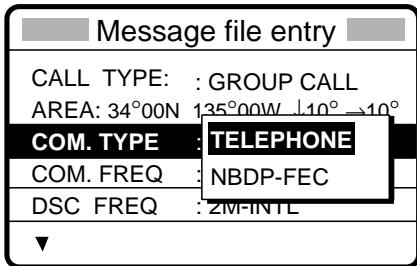

8. Rotate the [ENTER] knob to choose appropriate communications type and then push the [ENTER] knob.
9. Push the [ENTER] knob to open the COM. FREQ menu.

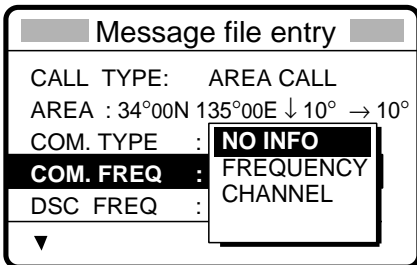

10. Rotate the [ENTER] knob to choose appropriate item and then push the [ENTER] knob. Enter channel or frequency. (See page 5-6 for how to enter channel and frequency.)
11. Push the [ENTER] knob to open the DSC FREQ menu.

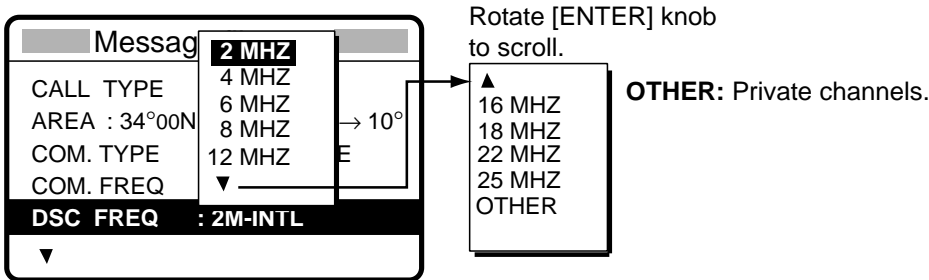

12. Rotate the [ENTER] knob to choose appropriate DSC band and then push the [ENTER] knob. Choose appropriate DSC frequency and then push the [ENTER] knob.
13. Follow "How to Enter File Name and Number" on page 6-3 to enter file name and number.

6.4 Preparing PSTN Calls

1. At the DSC standby screen, press the [# / SETUP] key to open the Setup menu.
2. Rotate the [ENTER] knob to choose MESSAGE and then push the [ENTER] knob.
3. Push the [ENTER] knob to open the CALL TYPE menu.

Message file entry	
CALL TYPE	INDIVIDUAL
STATION ID	PSTN CALL
COM. TYPE	GROUP CALL
COM. FREQ	AREA CALL
DSC FREQ	TEST CALL
▼	

4. Rotate the [ENTER] knob to choose PSTN CALL and then push the [ENTER] knob.
5. Push the [ENTER] knob to open the COAST ID entry window.

Message file entry	
CALL TYPE :	PSTN CALL
COAST ID	00000000
TEL NO. :	-----
DSC FREQ :	2M-INTL
▼	

6. Key in ID of coast station (seven digits) with the numeric keys then push the [ENTER] knob.
7. Push the [ENTER] knob to open the TEL. NO. entry window.

Message file entry	
CALL TYPE:	PSTN CALL
COAST ID :	001234567
TEL NO. :	□
DSC FREQ :	2M-INTL
▼	

8. Key in telephone no. (up to 16 digits) with the numeric keys and then push the [ENTER] knob.
9. Push the [ENTER] knob to open the DSC FREQ menu.

Message file entry	
CALL TYPE:	PSTN CALL
COAST ID :	001234567
TEL NO. :	□
DSC FREQ :	2M-INTL TL
▼	

Rotate the [ENTER] knob to scroll.

▲	16 MHZ
	18 MHZ
	22 MHZ
	25 MHZ
	OTHER

OTHER: Special, private channels.

10. Rotate the [ENTER] knob to choose appropriate DSC band and then push the [ENTER] knob. Choose appropriate DSC frequency and then push the [ENTER] knob.
11. Follow “How to Enter File Name and Number” on page 6-3 to enter file name and number.

6.5 Preparing Test Calls

1. At the DSC standby screen, press the [# / SETUP] key to open the Setup menu.
2. Rotate the [ENTER] knob to choose MESSAGE and then push the [ENTER] knob.
3. Push the [ENTER] knob to open the CALL TYPE menu.

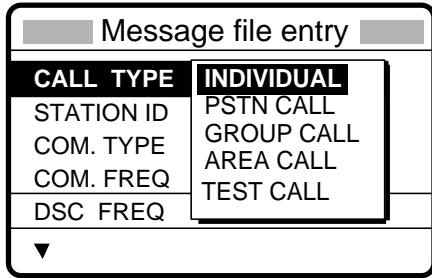

4. Rotate the [ENTER] knob to choose TEST CALL and then push the [ENTER] knob.
5. Push the [ENTER] knob to open the COAST ID entry window.

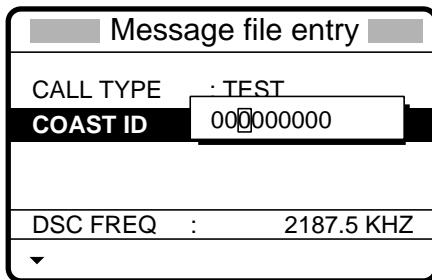

6. Enter coast ID where to send the test message and then push the [ENTER] knob.
7. Push the [ENTER] knob to open the DSC FREQ menu.

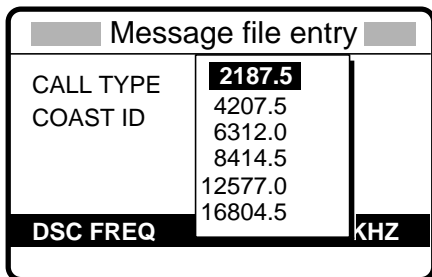

8. Rotate the [ENTER] knob to choose appropriate DSC frequency and then push the [ENTER] knob.
9. Follow “How to Enter File Name and Number” on page 6-3 to enter file name and number.

6.6 Sending Prepared Calls

Sending without modification

1. Press the [FILE/CURSOR] key at the DSC standby screen to show the send message file list. Below is an example of the send message file list.

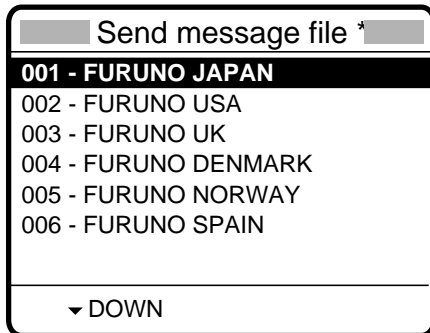

2. Rotate the [ENTER] knob to choose a file.
3. Press the [CALL] key to send the message.

Editing before sending

1. Press the [FILE/CURSOR] key at the DSC standby screen to show the send message file list.
2. Rotate the [ENTER] knob to choose file desired and then push the [ENTER] knob.



3. DETAIL is selected; push the [ENTER] knob. The message contents are shown on the "Compose message" screen.
4. Edit the message as necessary.
5. Press the [CALL] key to send the message.

6.7 Deleting Send Message Files

1. Press the [FILE/CURSOR] key at the DSC standby screen to show the send message file list.
2. Rotate the [ENTER] knob to choose file desired and then push the [ENTER] knob.



3. Rotate the [ENTER] knob to choose DELETE and then push the [ENTER] knob.

Note: You may collectively erase all send message files. For details see paragraph 5.11.

6.8 Printing List of Send Message Files

You can print a list of send message files as follows:

1. Press the [FILE/CURSOR] key to open the Send message file list.
2. Press the [8/PRINT] key.
3. YES is selected; push the [ENTER] knob to print.

```
***** Send message file *****  
001. FURUNO JAPAN      INDIVIDUAL CALL  
002. FURUNO USA       INDIVIDUAL CALL  
003. FURUNO UK        PSTN CALL  
004. FURUNO DENMARK   GROUP CALL  
005. FURUNO NORWAY    INDIVIDUAL CALL  
006. FURUNO SPAIN     ALL SHIPS CALL  
007. FURUNO FRANCE    INDIVIDUAL CALL
```

Note: Message not framed in actual printout.

7. DSC/WATCH RECEIVER SETUP

7.1 Setting Alarms

The Alarm menu enables/disables internal and external alarms. Note that the Distress/Urgency alarm cannot be disabled. Press the [# / SETUP] key at the DSC standby screen, choose ALARM and then push the [ENTER] knob to display the Alarm menu.

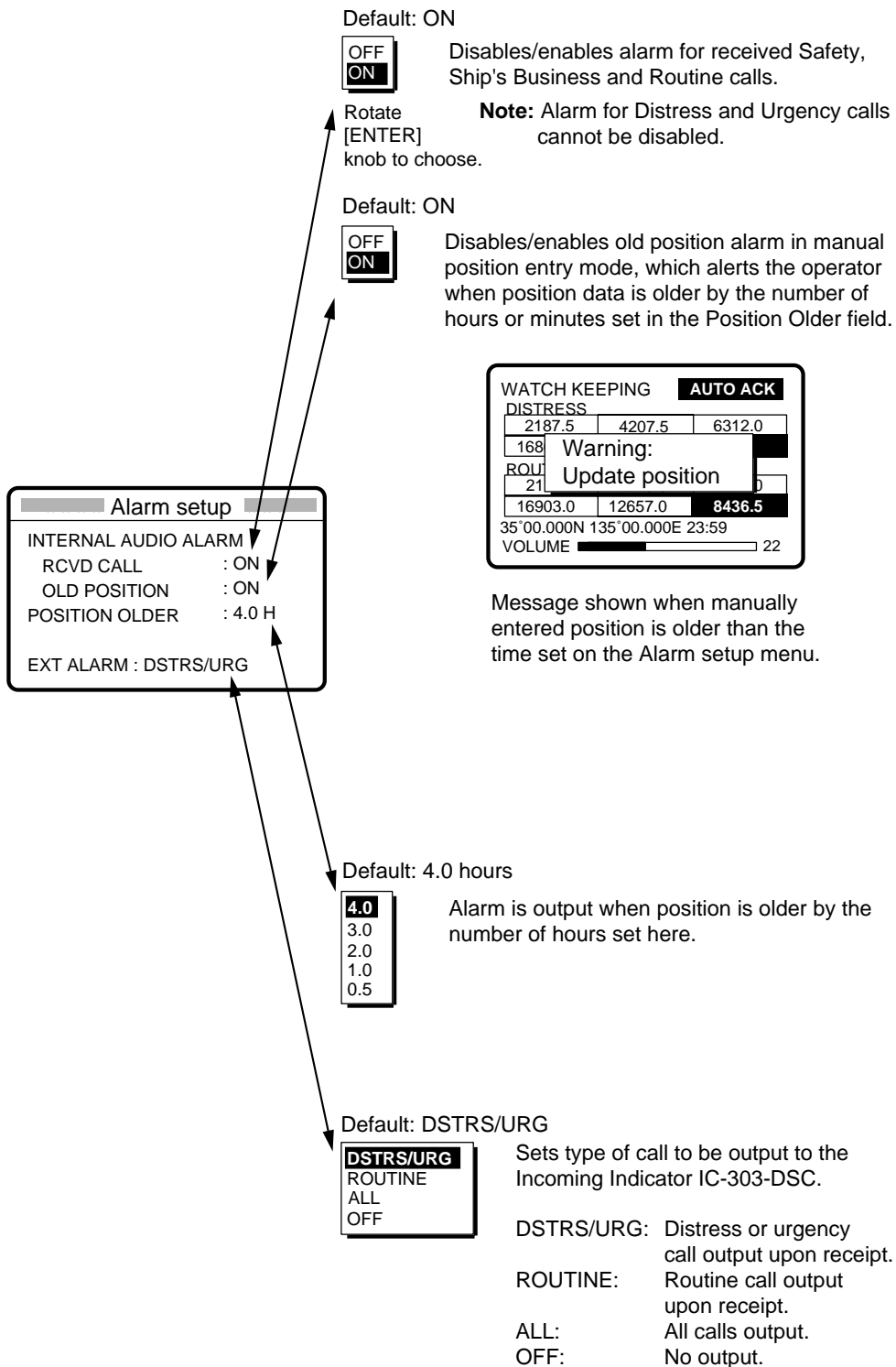

7.2 Auto Ack Menu

The Auto Ack menu enables/disables automatic acknowledgement of individual, position and polling calls. Press the [#SETUP] key, choose AUTO ACK at the DSC standby screen and then push the [ENTER] knob to display the Auto Ack setup menu.

Comply type	ABLE	UNABLE
Setting of [5/ACQ /SQ] key		
AUTO ACK	Can send acknowledge automatically	Can send UNABLE automatically.
MANUAL ACK	Can send acknowledge manually	Can send UNABLE manually.

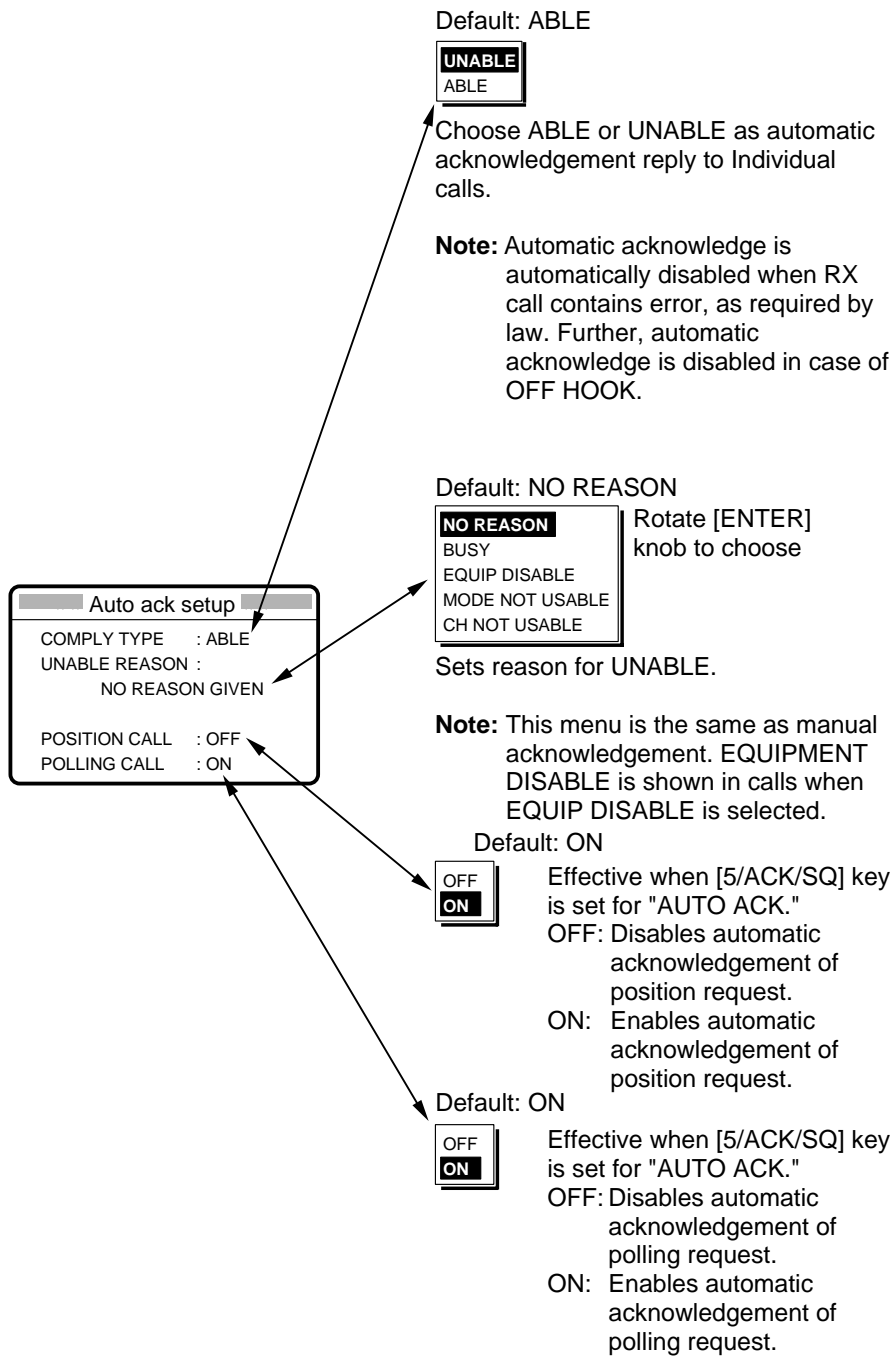

7.3 Printing Messages

The Print Out menu enables/disables automatic printing of all transmitted and received calls and the results of the daily test. Press the [#/SETUP] key at the DSC standby screen, choose PRINT OUT and then push the [ENTER] knob to display the Print Out menu.

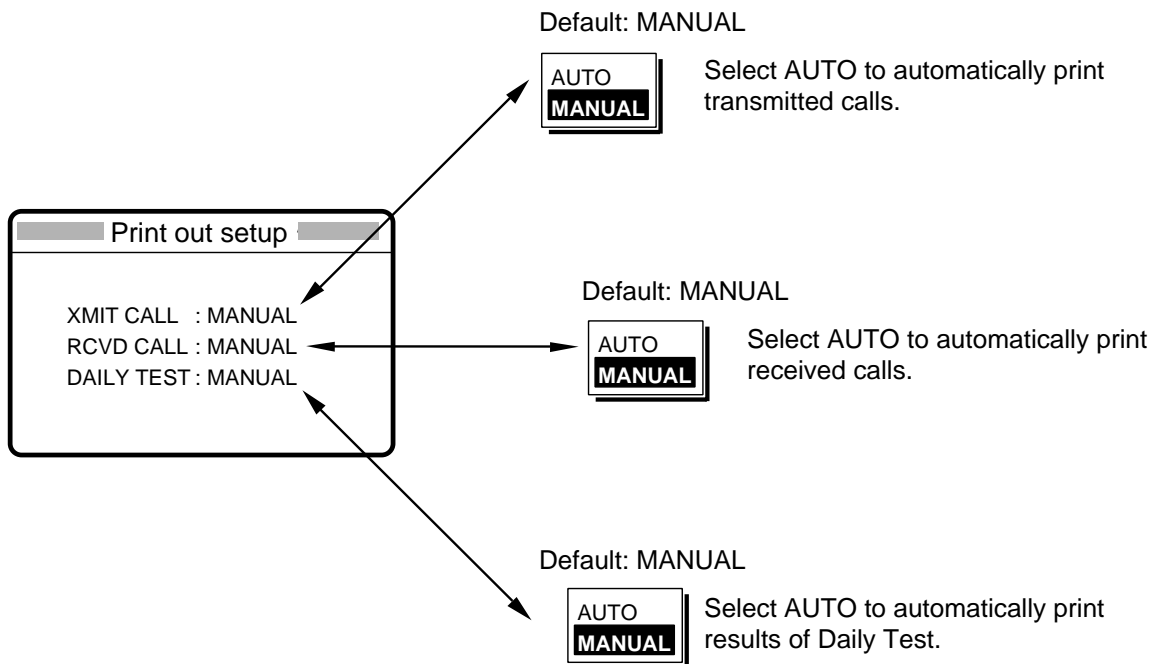

Sample printouts

Printing can be done automatically or manually. For manual printing, press the [8/PRINT] key. Note that calls having more than one page (for example, received calls) are printed out in their entirety.

```
* Received message at JAN-08-2002-16:10:12 *
FORMAT           : DISTRESS CALL
SELF-IDENTITY    : 987654321
NATURE OF DISTRESS : UNDESIGNATED DISTRESS
DISTRESS COORDINATES : NO INFORMATION
DISTRESS TELECOMMAND : J3E TELEPHONE
END OF SEQUENCE   : EOS
ERROR-CHECK      : OK

DSC FREQUENCY    TX: 2187.5 kHz
                  RX: 2187.5 kHz
```

Sample Received Message Printout (Distress)

```
* Received message at JAN-08-2002-16:10:12 *
FORMAT           : INDIVIDUAL CALL
ADDRESS          : 111660000
CATEGORY         : ROUTINE
SELF-IDENTITY    : 987654321
1st TELECOMMAND  : J3E TELEPHONE
2nd TELECOMMAND  : NO INFORMATION
WORKING FREQUENCY : NO INFORMATION
END OF SEQUENCE  : ACK. RQ
ERROR-CHECK      : OK

DSC FREQUENCY    TX: 2177.0 kHz
                  RX: 2177.0 kHz
```

Sample Received Message Printout (Individual)

```
***** Send message *****
FORMAT           : INDIVIDUAL CALL
ADDRESS          : 111660000
CATEGORY         : ROUTINE
SELF-IDENTITY    : 987654321
1st TELECOMMAND  : J3E TELEPHONE
2nd TELECOMMAND  : NO INFORMATION
WORKING FREQUENCY : NO INFORMATION
END OF SEQUENCE  : ACK. RQ

DSC FREQUENCY    TX: 2177.0 kHz
                  RX: 2177.0 kHz
```

Sample Send Message Printout (Individual)

```
*Transmitted message at JAN-08-2002-16:10:12 *
FORMAT           : INDIVIDUAL CALL
ADDRESS          : 987654321
CATEGORY         : ROUTINE
SELF-IDENTITY    : 111660000
1st TELECOMMAND  : J3E TELEPHONE
2nd TELECOMMAND  : NO INFORMATION
WORKING FREQUENCY : NO INFORMATION
END OF SEQUENCE  : ACK. RQ

DSC FREQUENCY    TX: 2177.0 kHz
                  RX: 2177.0 kHz
```

Sample Transmitted Message Printout (Individual)

Note: Messages are not framed in actual printouts.

7.4 Setting Scan Frequencies

The Scan freq menu determines which DSC routine and distress frequencies to scan. Follow the instructions below to select/deselect DSC routine and distress frequencies to scan.

7.4.1 Distress frequencies

1. Press the [#]/SETUP key at the DSC standby screen, choose SCAN FREQ and then push the [ENTER] knob to display the SCAN FREQ menu.

Scan freq setup	
ROUTINE	DISTRESS
F1 : 2M-INTL	2M : FIXED
F2 : 4M-INTL	4M : ON
F3 : 6M-INTL	6M : ON
F4 : 8M-INTL	8M : FIXED
F5 : 12M-INTL	12M : ON
F6 : 16M-INTL	16M : OFF

2. Rotate the [ENTER] knob clockwise to shift the cursor to the DISTRESS column.
3. Rotate the [ENTER] knob to choose the frequency to process and then push the [ENTER] knob. For example, choose 4 MHz.

Scan freq setup	
ROUTINE	DISTRESS
F1 : 2M-INTL	2M : OFF
F2 : 2M-INTL	4M : ON
F3 : 4M-INTL	6M : ON
F4 : 8M-INTL	8M : FIXED
F5 : 12M-INTL	12M : ON
F6 : 16M-INTL	16M : OFF

4. Rotate the [ENTER] knob to choose ON or OFF as appropriate and then push the [ENTER] knob.
5. Press the [CANCEL] key twice to return to the DSC standby screen.

Note: Regulations require that 2 MHz and 8 MHz and one more DSC distress frequency be watched continuously. These frequencies cannot be turned off. Maximum three bands may be turned off.

7.4.2 Routine frequencies

1. Press the [#]/SETUP key, choose SCAN FREQ and then push the [ENTER] knob to display the Scan freq menu.

Scan freq setup	
ROUTINE	DISTRESS
F1 : 2M-INTL	2M : FIXED
F2 : 4M-INTL	4M : ON
F3 : 6M-INTL	6M : ON
F4 : 8M-INTL	8M : FIXED
F5 : 12M-INTL	12M : ON
F6 : 16M-INTL	16M : OFF

2. Rotate the [ENTER] knob to choose the frequency to process and then push the [ENTER] knob. For example, choose F1: 2 M-INTL.

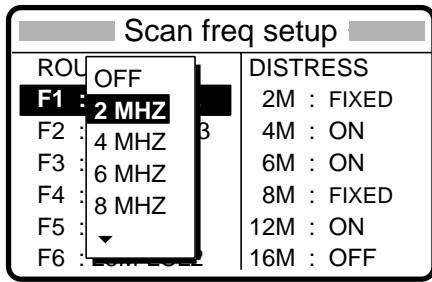

3. Push the [ENTER] knob, and the display looks something like the one below.

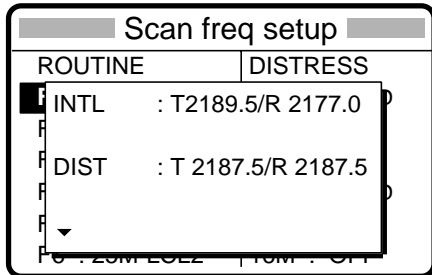

4. Rotate the [ENTER] knob to choose frequency desired and then push the [ENTER] knob.

INTL: International channels

DIST: Distress channels

LOCAL1/LOCAL2: Local channels

USER CH: User channels

5. Press the [CANCEL] key twice to return to the DSC standby screen.

Note: Distress frequencies can be stored on the routine frequency memory. This is convenient for backing up the watch keeping receiver.

7.5 Adjusting Volume

The Volume menu enables/disables key beep (acknowledges correct key input) and adjusts the volume of the handset, ordinary alarm and distress/urgency alarm. Press the [#/SETUP] key at the standby screen, choose VOLUME and then push the [ENTER] knob to display the Volume setup menu.

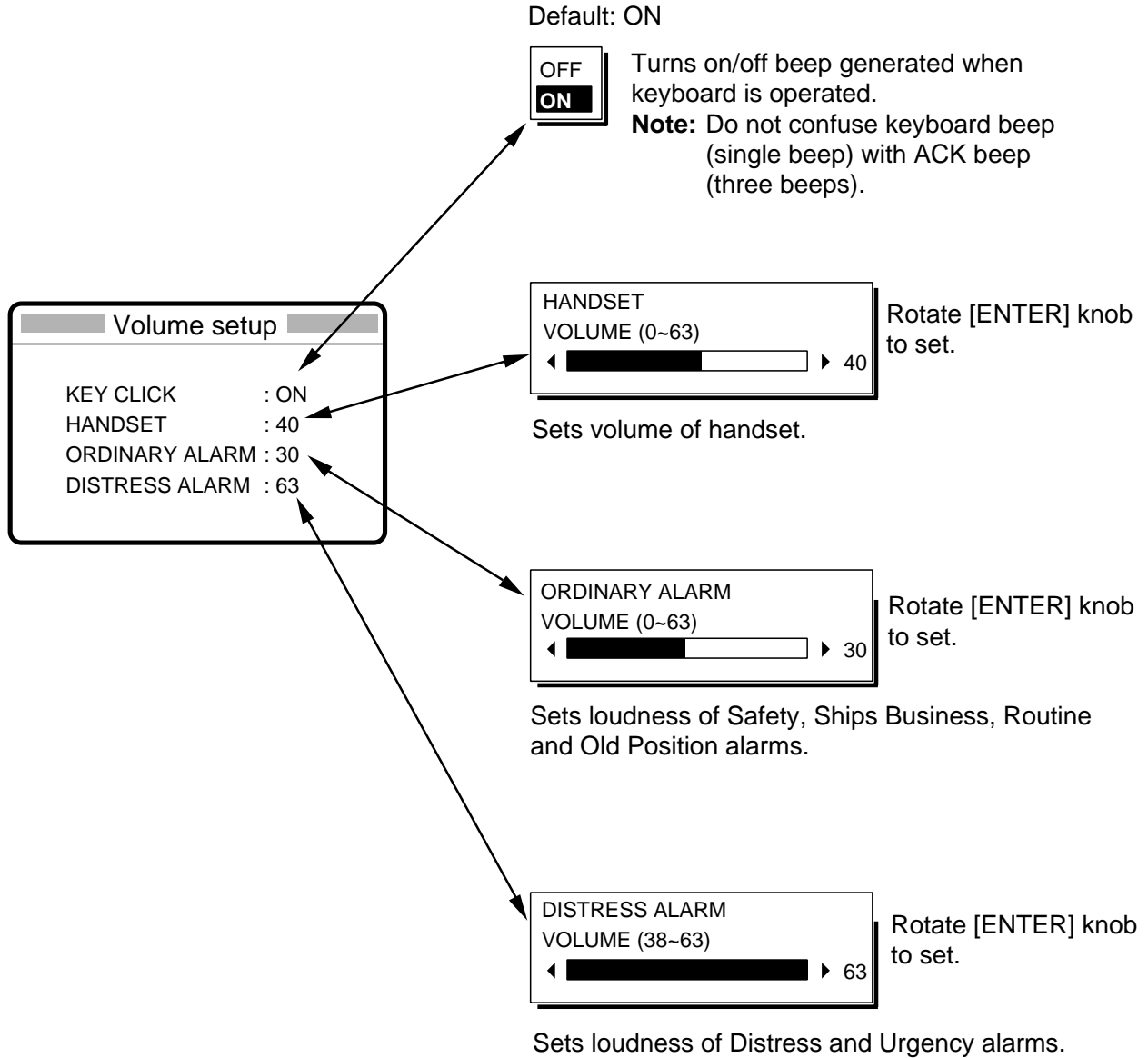

8 NBDP SYSTEM OVERVIEW

8.1 Turning on the NBDP System

Turn on the terminal unit and the printer with their respective power switches.

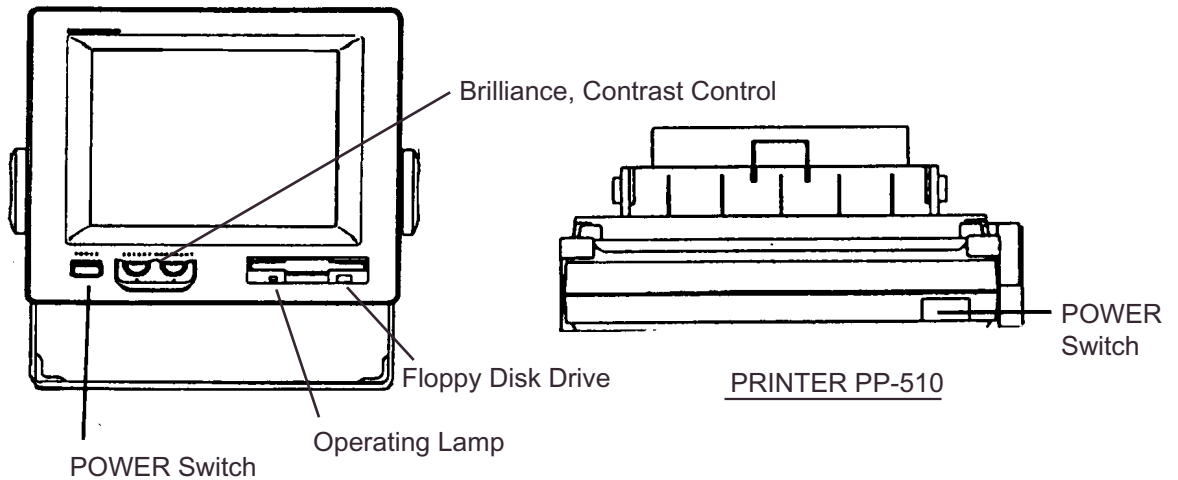

TERMINAL UNIT IB-581

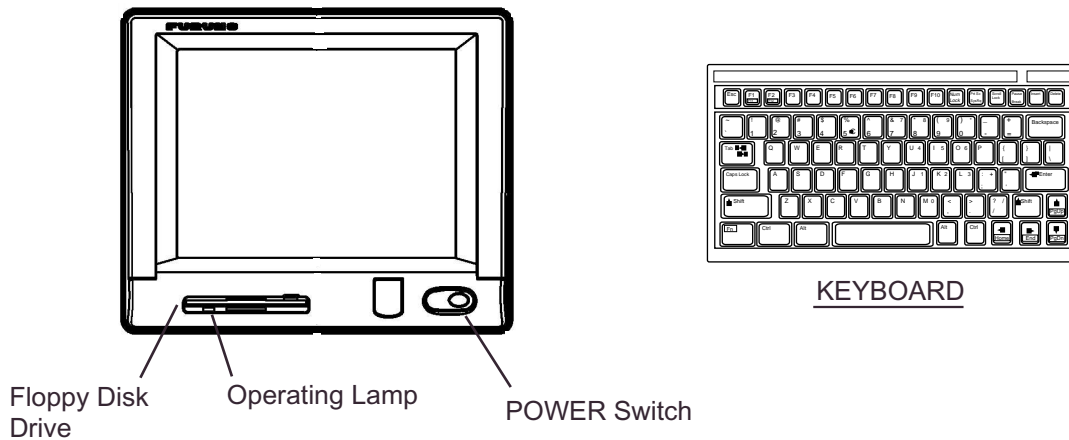

TERMINAL UNIT IB-583

NBDP terminal unit, printer and keyboard

Note 1: The Printer PP-510 prints messages. Refer to its operator's manual for operating information.

Note 2: When the NBDP controller has priority the radiotelephone displays "OCCUPIED (NBDP)." At this time the volume of the speaker may be adjusted by rotating the [ENTER] knob and observing the VOL indicator on the radiotelephone.

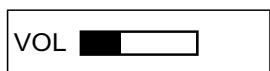

8.2 Description of Equipment

8.2.1 Terminal unit

The terminal unit is a visual display incorporating a floppy disk drive, which provides for storage of files on floppy disks. Two models are available, IB-581 (monochrome) and IB-583 (color). Controls for power and adjustment of display brilliance and contrast are provided on the front panel of the IB-581. To adjust the brilliance on the IB-583, press [Alt] while pressing [F6] to lower the brilliance; [F7] to raise it. (The IB-583 does not have a control for adjustment of contrast.) Eight levels of brilliance are available.

When the terminal unit is turned on, the communication status display, shown below, appears. This is where all phases of telex communications begin.

```

1:File 2:Edit 3:Operate 4:Window 5:Station 6:System 7:WRU 8:HR 9:Over 10:Break
----- 2002-10-15 2:26:45 UTC -----Caps-Eng
Station Name      :
Frequency (T/R)  :          /          (kHz)  Comm Mode :
Comm Status      :  Connect Send Lock Error
Sending Volume   :          (%)   ARQ Error : 0   ARQ Time : 0(sec)
-----

```

Communication status display

Features of the IB-583

The IB-583 is fitted with both English and Russian interface. Choose desired interface as below:

English: Turn on the IB-583 while pressing the [E] key.

Russian: Turn on the IB-583 while pressing the [R] key.

The IB-583 has a battery (type CR2450-F2ST2L, code no. 000-144-941) on its TERM/CPU Board (16P0209) and its life is about six years. When the voltage of the battery is low, the time will be slow. When this occurs, contact your dealer about replacement of the battery.

8.2.2 Keyboard

The terminal unit is operated from the keyboard, and is almost 100% keyboard controlled. Operation is simplified by the use of menus which you access by pressing a function key, labeled F1-F10 at the top of the keyboard. The figure below shows the function menus and their corresponding function keys.

FILE EDIT OPERATE WINDOW STATION SYSTEM WRU HR OVER BREAK

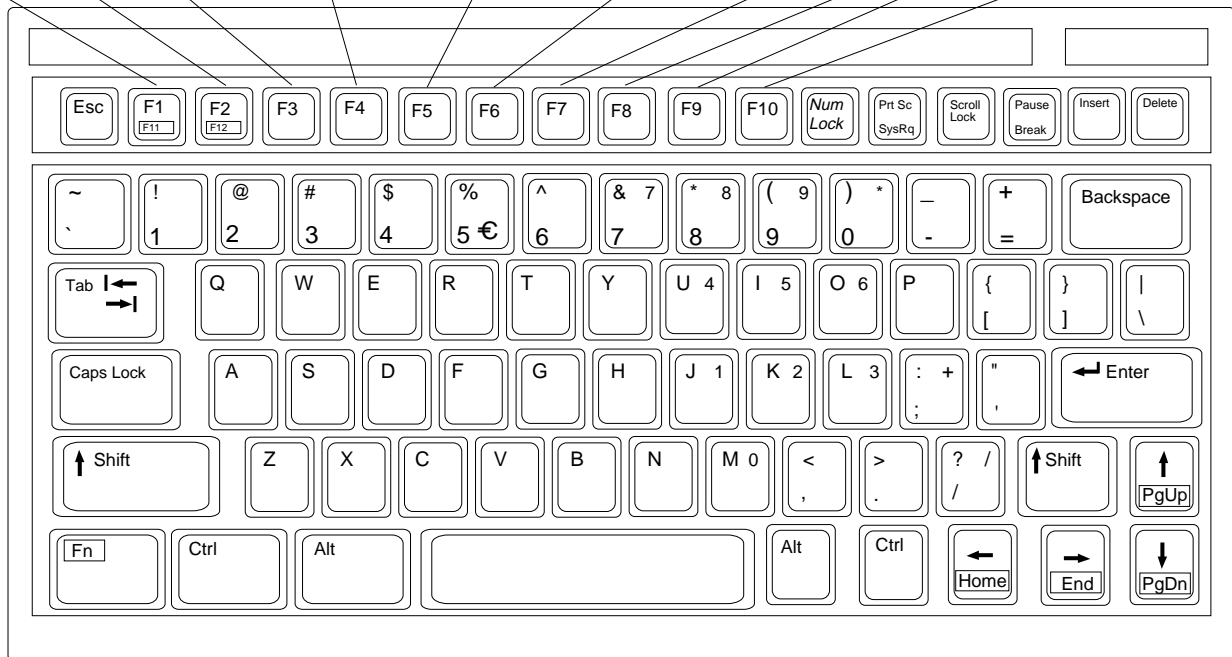

Keyboard

Note: € (Euro mark) on  key is not used.

8.3 Function Keys, Menu Operation

The function keys at the top of the keyboard control most operations of this unit through a menu system.

8.3.1 Menu conventions

Inverse video

As you move the cursor down through a menu, a selected item, initially shown as white on black (monochrome display), inverses to black on white. This highlighting indicates that it is available for selection.

Underline

The underline shows current selection. In the figure below, for example, the underline is beneath "Receive."

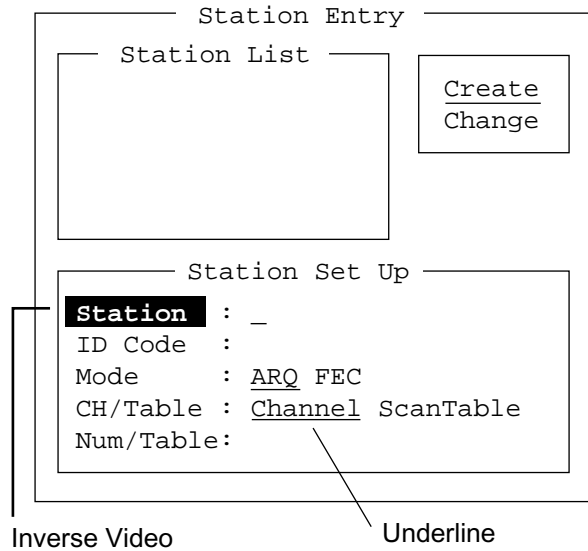

Station entry screen IB-581

Note: The example display screens shown in this manual are taken from the IB-581. The screens of the IB-583 are nearly identical to those of the IB-581 except cursor configuration.

Cursor	IB-581	IB-583
	—	█

8.3.2 Menu overview

Selecting menus

Press appropriate function key to open a menu. To display the File menu, for example, press the function key [F1].

```
      File
-----
1: New
2: Open
3: Close
-----
4: Delete
-----
5: Rename
-----
6: Real Time Printing
7: File to Print
8: Cancel Printing
-----
9: Clear Buffer
-----
0: Floppy Disk Format
```

File menu

Selecting menu items and options

Menu items can be selected by pressing appropriate numeric key or selecting item desired with the arrow keys and pressing the [Enter] key. Menu options can be selected by operating the [←] or [→] keys. After selecting option desired, press the [Enter] key to register your selection and close the menu.

8.3.3 Function key description

Function key [F1]: File menu

The File menu is where you will create, open, save and print telex messages. Floppy disks are also formatted from this menu.

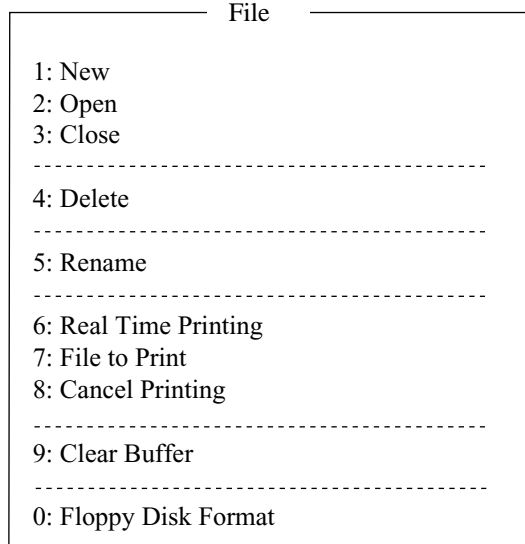

File menu

- | | |
|------------------------------|-----------------------------------|
| 1: New | Opens a new untitled window. |
| 2: Open | Opens files. |
| 3: Close | Closes files. |
| 4: Delete | Deletes files. |
| 5: Rename | Renames files. |
| 6: Real Time Printing | Turns real time printing on/off. |
| 7: File to Print | Prints files. |
| 8: Cancel Printing | Stops printing. |
| 9: Clear Buffer | Clears the communications buffer. |
| 0: Floppy Disk Format | Formats a floppy disk. |

Function key [F2]: Edit menu

The Edit menu provides a full line of editing features.

Edit	
1:	Undo

2:	Cut
3:	Copy
4:	Paste

5:	Select All

6:	Search
7:	Replace

8:	Goto Top
9:	Goto Bottom
0:	Goto Line

A:	Change Text

Edit menu

1: Undo	Cancels the last change (cut, copy or paste).
2: Cut	Removes the selected text and stores it in the paste buffer. (Previous text in the paste buffer is cleared.)
3: Copy	Copies the selected text and stores it in the paste buffer. (Previous text in the paste buffer is cleared.)
4: Paste	Inserts the text stored in the paste buffer at the current location of the cursor.
5: Select All	Selects the entire current file for cut or copy.
6: Search	Searches a file for a character string.
7: Replace	Replaces a word with a different word or character string.
8: Goto Top	Brings the cursor to the top line of the current file.
9: Goto Bottom	Brings the cursor to last line of the current file.
0: Goto Line	Moves the cursor to the desired line in the current file.
A: Change Text	Switches between the display window 1 and 2.

Function key [F3]: Operate menu

The Operate menu mainly controls transmitting and receiving.

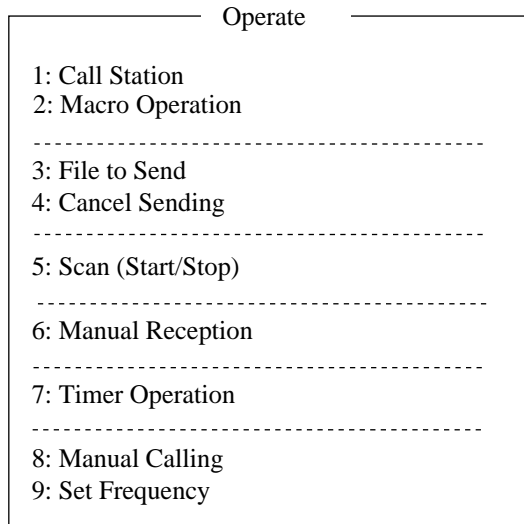

Operate menu

- | | |
|----------------------------|--|
| 1: Call Station | Chooses a station from the station list. |
| 2: Macro Operation | Enables macro operation. For details, see paragraph 11.10. |
| 3: File to Send | Selects a file (to transmit). |
| 4: Cancel Sending | Stops sending a file. |
| 5: Scan Start/Stop | Starts/stops frequency scanning. |
| 6: Manual Reception | Selects communication mode for reception; AUTO, ARQ, FEC DIRC. |
| 7: Timer Operation | Timer programming. |
| 8: Manual Calling | Sets TX mode and subscriber's ID number in manual calling. |
| 9: Set Frequency | Sets TX and RX frequencies in manual calling. |

Function key [F4]: Window menu

The Window menu lets you display the corresponding data of the window below.

Window	
1:	Calendar

2:	Distress Frequency Table

Window menu

1: Calendar Displays desired calendar month and year. To change year or month, choose item with [↑] or [↓] key and change setting with [←] or [→] key.

2: Distress Frequency Table Displays all distress frequencies.

Distress Frequencies						
Telephone (kHz):	2182.0	4125.0	6215.0	8291.0	12290.0	16420.0

NBDP (kHz) :	2174.5	4177.5	6268.0	8376.5	12520.0	16695.0

DSC (kHz) :	2187.5	4207.5	6312.0	8414.5	12577.0	16804.5

Function key [F5]: Station menu

The Station menu provides for storage of stations, timer program setup, user channel setup, and entry of various ID codes.

Station	
1:	Station Entry

2:	Timer Operation Entry

3:	Scan Entry

4:	User Channel Entry

5:	Answerback Code Entry

6:	Group ID Entry (4/5 digit)
7:	Group ID Entry (9 digit)
8:	Select ID Entry (4/5 digit)
9:	Select ID Entry (9 digit)

Station menu

1: Station Entry	Registers stations.
2: Timer Operation Entry	Registers timer programs.
3: Scan Entry	Creates scan groups for scanning.
4: User Channel Entry	Registers user channels.
5: Answerback Code Entry	Registers own ship's answerback code.
6: Group ID Entry	Registers own ship's group ID codes (4 or 5 digit).
7: Group ID Entry	Registers own ship's group ID codes (9 digit).
8: Select ID Entry	Registers own ship's selective ID codes (4 or 5 digit).
9: Select ID Entry	Registers own ship's selective ID codes (4 or 5 digit).

Function key [F6]: System menu

The System menu is mainly for use by technicians and contains diagnostic tests. To change settings, choose "Change" from the item "Setup" and operate arrow keys to choose item and option. Press the [Enter] key to register selection and close the menu.

System	
Setup	Lock Change Default
Slave Delay	8 msec (0- 50 msec)
TX/RX MSG Save	OFF ON
Edit Before sending	OFF ON
Time System	OFF UTC SMT JST
Time & Date	2002/10/16 10:00:00
Display Mode*	Normal Reverse
Self Test	

* = "Window Color" shown on IB-583.

System menu**Setup**

Locks, changes settings; restores default system settings.

Slave Delay

Sets the length of the slave delay timing from the end of RX to the start of TX in the ARQ mode. The default setting is suitable in most cases. This item cannot be adjusted by the user.

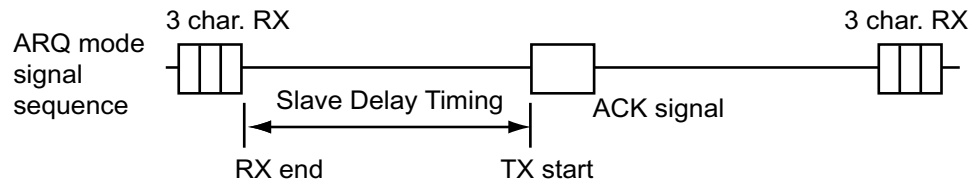
**TX/RX MSG Save**

Turn on to automatically save incoming and outgoing messages to a floppy disk. "Log" appears at the top of the screen when on.

Edit Before sending

"OFF" transmits keying operation one by one. "ON" transmits message only when the [Enter] key is pressed after confirming text typed.

Time System

Chooses time system. SMT is local time and JST is Japan standard time.

Time & Date

Enter date and time manually. If a navigation device is connected, the time is automatically set when the power is turned on or whenever the time system is switched. Manual entry takes priority over automatic entry. This item cannot be adjusted when using JST or UTC.

Display Mode (IB-581) Selects display mode to normal and reverse alternately.

Window Color (IB-583) Chooses display colors. To change display colors:

1. Choose the option Change from Setup.
2. Press the [↓] key to choose Window Color and press the [Enter] key.

```

Window Color Change
-----
Window Color Setup
Default Color
-----
To Change: ENTER To quit: ESC
    
```

3. The cursor is choosing Window Color Setup; press the [Enter] key.

```

Window Color Setup
-----
Window : Base Window
Fore Color : L_WHITE
Back Color : BLUE
-----
To Change: ENTER To Change Value: L<=>R
    
```

4. Press the [→] key to choose the item to change: BASE WINDOW, BACK SCROLL, EDIT 1-3, FUNCTION, SUB MENU 1-3, MESSAGE.
5. Press the [↓] key to choose Fore Color.
6. Press the [→] key to choose color: L-WHITE, BLACK, BLUE, GREEN, CYAN, RED, MAGENTA, BROWN, WHITE, GRAY, L-BLUE, L-GREEN, L-CYAN, L-RED, MAGENTA, YELLOW.
7. Press the [↓] key to choose Back Color.
8. Press the [→] key to choose color.
9. Press the [↑] key to choose Window.
10. Repeat the step 4 to 9 to set other colors.
11. Press the [Enter] key followed by the [Esc] key.

Self Test: Starts diagnostic test.

Function key [F7]: WRU (Who Are You?): In the ARQ mode, requests other station's answerback code.

Function key [F8]: HR (Here Is): In the ARQ mode, sends your ship's answerback code.

Function key [F9]: OVER: In the ARQ mode, switches the direction of traffic; the information receiving station becomes the information sending station, the information sending station becomes the information receiving station.

9 NBDP PREPARATIONS

This chapter provides the procedures necessary for preparing the NBDP Terminal Unit for transmitting and receiving. For automatic telex, you will need to register the following:

- Your ship's ID and answerback codes
- Stations
- Timer programs
- Scan channel groups
- User channels

9.1 Registering Answerback Code & ID Codes

Enter your ship's answerback code and ID codes as shown below.

Note: The answerback and ID codes cannot be changed once entered; be sure to enter the codes correctly.

9.1.1 Registering answerback code

1. Press the function key [F5] and then the [5] key. The display should look something like the illustration below.

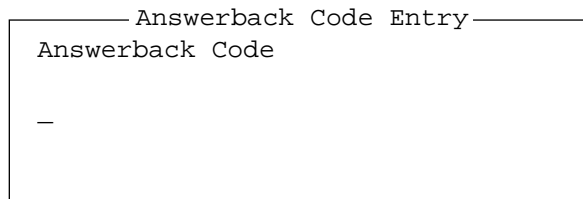

```
Answerback Code Entry
Answerback Code
_
```

Answerback code entry screen

2. Enter your ship's answerback code (max. 20 characters, including spaces) and press the [Enter] key. The prompt "OK/Cancel" asks for verification of data. If the code is correct, press the [Enter] key again.

Note: Example of answerback code: 12345789 FURU X.

For final verification of the data, the Caution shown in the illustration below appears.

```

Answerback Code Entry
Answerback Code
123456789 FURU X
    
```

O K

Cancel

```

Caution
Confirm the 'CODE' before pressing ENTER key.
You cannot change the CODE once it has been entered.
    
```

Message for confirmation of code entered

3. If the code is correct, press the [Enter] key again.

9.1.2 Registering ID codes

1. Press function key [F5] and then the [6], [7], [8] or [9] key to enter the Group ID Code (4 or 5 digits), Group ID Code (9 digits), Select ID Code (4 or 5 digits) or Select ID Code (9 digits), respectively.

```

Select ID Entry
Select ID Code (4/5)
-
    
```

ID code screen

2. Enter Group ID or Select ID as appropriate and then press the [Enter] key. A prompt asks you to verify data. If the ID is correct, press the [Enter] key.

For final verification of the data, the Caution shown in the illustration below appears.

```

Select ID Entry
Select ID Code (4/5)
12345
    
```

O K

Cancel

```

Caution
Confirm the 'CODE' before pressing ENTER key.
You cannot change the CODE once it has been entered.
    
```

Message for confirmation of code entered

3. If the ID is correct, press the [Enter] key again.

9.2 Station List

The station list provides for storage of up to 50 stations, one frequency pair (RX and TX) per station. For stations which have more than one frequency pair, you might add a suffix

to the station name to denote multiple frequency pairs. For example, station name FURUNO followed by -1, -2, -3, etc. for each frequency pair required.

9.2.1 Registering stations

1. Press the function key [F5] followed by the [1] key to show the Station Entry screen.

```

Station Entry
-----
Station List
-----
Create
Change

Station Set Up
-----
Station : _
ID Code :
Mode    : ARQ FEC
CH/Table : Channel ScanTable
Num/Table:
  
```

Station entry screen

2. On the right-hand side of the screen, Create and Change are shown and Create should be underlined. If it is not, underline it by pressing [→], [↑] and the [Enter] key.
3. The cursor is now choosing Station. Enter station name, using up to 18 characters.
4. Press the [↓] key to choose ID Code. Enter station ID code.
5. Press the [↓] key to choose Mode. Choose communication mode with [←] or [→] among the following:
 - ARQ:** Automatic Retransmission Request
 - FEC:** Forward Error Correction
6. Press the [↓] key to choose CH/Table. Choose ScanTable or Channel as appropriate.
7. Press the [↓] key to choose Num/Table.

9 NBDP PREPARATIONS

- If you selected "Channel" at step 6, enter ITU channel number (see Appendix) or User channel number.

If you selected "ScanTable" at step 6, press the [→] key to show scan group list registered. For scan group, refer to paragraph 9.5. Choose a scan group name by using the [↓] or [↑] key followed by pressing the [Enter] key.



Scanning group list

- Press the [Enter] key. The prompt OK/Cancel asks for verification of data.



OK/Cancel prompt

- If the data are correct, press the [Enter] key. (To cancel entry, place the cursor on Cancel by pressing the [↓] key, and then hit the [Enter] key. Data entered are erased.) The station name entered at step 3 appears at the Station List window.
- To register other stations, press the [Enter] key twice and then repeat steps 3 through 10.
- Press the [↓] key. Check data on the Station List for correctness. Stations displayed in reverse video on the Station List are displayed on Station Set Up.
- Press the [ESC] key to quit.

Note 1: If you enter a station which already exists, the indication "Station by that name already exists. Press any key to escape." appears. Press any key to return to the Station List. Check the list.

Note 2: If you enter an invalid code, the message "Input Error. (ID Code) Press any key to escape." appears. Press any key and reenter ID code.

9.2.2 Editing/Deleting stations

- Press the function key [F5] and then the [1] key.
- Press the [↓] key to choose a station name from the Station List.
- Press the [→] key followed by [↓] key to choose Change and press the [Enter] key.
- Do one of the following;
 - Edit station:** Use [↑], [↓] and the [Backspace] key to make corrections.
 - Delete station:** Erase station name with the [Backspace] key.
- Press the [Enter] key twice.
- Press the [Esc] key.

9.3 Timer Programming

A built-in timer allows you to automatically receive and transmit files. 10 timer programs can be registered.

9.3.1 Registering timer programs

1. Press the function key [F5] and the [2] key to display the Timer Operation Entry screen.

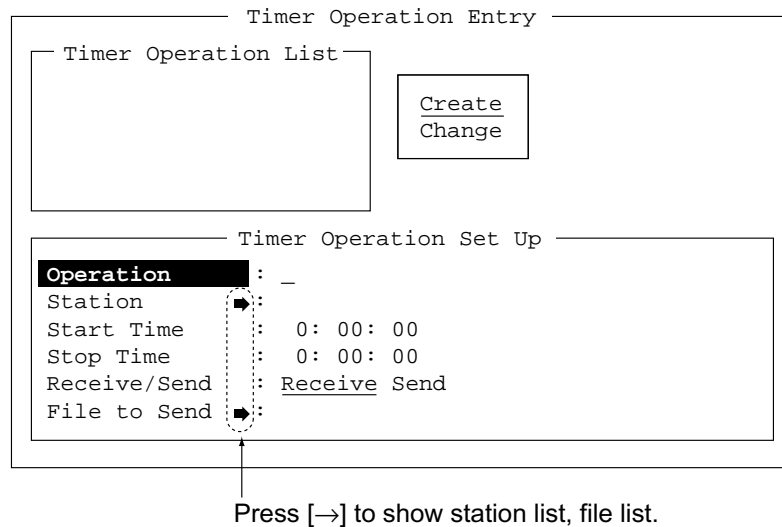

Timer operation entry screen

2. If Create is not underlined, press [->], [↑] and the [Enter] key to underline it.
3. Operation is selected. Enter a suitable operation name on the Operation line. Any alphanumeric characters may be used.

Note: If the operation name entered already exists, the display “Operation name already exists. Press any key to escape.” Press any key and change the operation name.
4. Press the [↓] key to choose Station. Press the [->] key to display the Station List (which you registered stations in the previous paragraph.) Choose a station and press the [Enter] key.
5. Press the [↓] key to choose Start Time. Enter start time, in 24-hour notation. To have the operation start at 8:35 a. m., for example, the keying sequence would be;

[0] [8] [3] [5] [0] [0]
6. Press the [↓] key to choose Stop Time. Enter stop time, in 24-hour notation.
7. Press the [↓] key to choose Receive/Send. Choose operation category; Receive or Send. If you have chosen “Send,” go to step 8. For “Receive,” go to step 9.
8. For send, insert the floppy disk which you want to send in the floppy drive, press the [↓] key to choose File to Send, press the [->] key to display the TX window, choose a file, and press the [Enter] key.
9. Press the [Enter] key.
10. Press the [Enter] key. The operation name appears in the Timer Operation List.

Note: If the station name entered has not been registered, the display shows “Operation name already exists. Press any key to escape.” Press any key and change operation name.

11. To enter another timer program, press the [Enter] key twice and the repeat steps 3-10.
12. Press the [Esc] key to finish.

9.3.2 Editing/Deleting timer programs

1. Press the function key [F5] and the [2] key.
2. Choose a timer program name from the Timer Operation List.
3. Press the [→] key to choose Change and press the [Enter] key.
4. Do one of the following;
 - Edit program:** Use [↑], [↓] and the [Backspace] key to make corrections.
 - Delete program:** Erase operation name with the [Backspace] key.
5. Press the [Enter] key twice.
6. Press the [Esc] key.

9.4 User Channels

The user channel list provides storage for up to 100 user channels, numbered 0-99. Note that user channels may be used in channel scanning.

9.4.1 Registering user channels

1. Press the function key [F5] and then the [4] key to show the User Channel Entry screen.

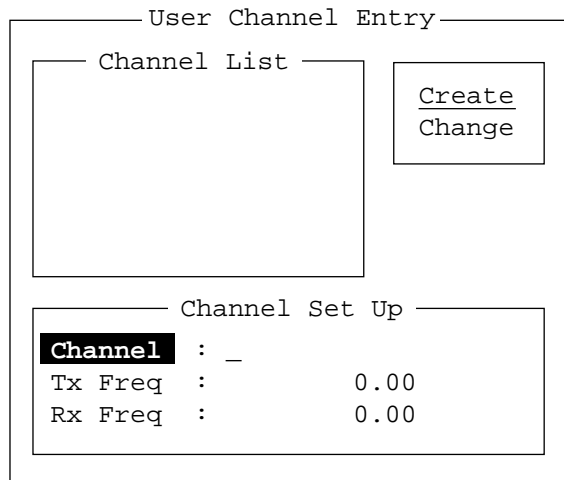

User channel entry screen

2. If Create is not underlined, press [→], [↑] and the [Enter] key to underline it.
3. Channel is selected. Enter channel number. (100 channels may be registered. When you attempt to register more, the message “Channel memory is full. Press any key to escape.” appears. In this case delete unnecessary channels to register new ones.)
4. Press the [↓] key to choose “Tx Freq.” Enter TX frequency.
5. Press the [↓] key to choose “Rx Freq.” Enter RX frequency.
6. Press the [Enter] key. The “OK/Cancel” confirmation window appears.
7. Press the [Enter] key. Channel number entered appears in the Channel List. (If the channel entered already exists, the message “Channel by that number already exists. Press any key to escape.” appears. Press any key and then reenter number.)

8. To quit, press the [Esc] key.

9.4.2 Editing/Deleting user channels

1. Press function key [F5] and then the [4] key.
2. Press the [↑] or [↓] key to choose channel from the Channel List.
3. Press [→] and [↓] keys to choose Change and press the [Enter] key.
4. Do one of the following:
 - Edit channel:** Use [↑], [↓] and the [Backspace] key to make modifications.
 - Delete channel:** Erase channel number with the [Backspace] key.
5. Press the [Enter] key twice.
6. Press the [Esc] key.

9.5 Scan Channel Groups

You may store up to 10 scan groups, 20 channels per group. Note that scanning is only possible in the ARQ and FEC-collective modes.

The NBDP Terminal Unit can automatically control radio equipment through channel scanning. The radio equipment scans a number of channels (according to your selection), stopping when an incoming signal is found. In the ARQ mode it stops when your own ID code is detected in an incoming signal. Also, in the ARQ mode, the transmitter is then tuned to the corresponding transmitter frequency, the communication link is established and the traffic is automatically exchanged. Scanning resumes once the link is disconnected.

9.5.1 Registering scan channel groups

You may register ITU and user scan channels as follows:

1. Press the function key [F5] followed by the [3] key to display the Scan Entry screen.

Scan Entry

Scanning Group List

Create
Change

Scanning Set Up

Group Name : _

Ch Dwell Time : 4.5 sec (2.7-4.5 sec)

Mode : AUTO ARQ FEC

Auto Search : OFF ON

No	Channel	Rx Freq	Tx Freq	Pass/Scan
0				Pass/Scan
1				Pass/Scan
2				Pass/Scan
3				Pass/Scan
4				Pass/Scan
▼ 5				

Scan entry screen

2. If Create is not underlined, press [→], [↑] and the [Enter] key to underline it.

3. Group Name is selected. Enter suitable group name. (10 group names may be entered. If you attempt to enter more the message "Scan group memory is full. Press any key to escape." appears. Press any key and then delete unnecessary group names to enter new ones.)
4. Press the [↓] key to choose CH Dwell Time. Enter channel dwell time in seconds. Dwell time is the time in seconds the receiver waits on each channel in a scan group before it selects the next frequency.
5. Press the [↓] key to choose Mode, and then choose the communication mode; AUTO, ARQ or FEC.

Note: AUTO is used to register scanning channel group when both ARQ and FEC exist in the same Scanning Channel Group. When you choose scan group by the call station menu, set Mode to FEC. See paragraph 11.3.

6. Press the [↓] key to choose Auto Search. Choose Auto Search to ON or OFF.
 - Auto Search ON:** The radio stops scanning when it finds the strongest signal (highest S/N ratio). To find the strongest signal, the radio scans all channels, which may take some time. Therefore, use this setting where signal propagation is poor.
 - Auto Search OFF:** The radio stops scanning on the first signal it finds. We recommend that you set Auto Search to OFF when signal propagation is good.

7. Press the [↓] key to choose line no. 1 in the Scanning Set Up window. Enter channel number (ITU or user channels) and press the [→] key to choose "Scan." (If you enter an invalid channel, the message "Channel by that name does not exist. Press any key to escape." appears. Press any key and reenter channel.)
8. Press the [↓] key to choose line No. 2. Enter channel number.
9. Enter other channel numbers and then press the [Enter] key. A confirmation message appears.
10. Press the [Enter] key again to save the data. The group name is displayed in the Scanning Group List window. (If the group name already exists, the message "Scan group by that name already exists. Press any key to escape." appears. Press any key and change the scan group name.)
11. To continue, press the [Enter] key twice and then repeat steps 3-10.
12. Press the [Esc] key to quit.

9.5.2 Editing/Deleting scan channel groups

1. Press the function key [F5] and the [3] key. Choose scan group name from the Scanning Group List.
2. Press the [→] key to choose Change and press the [Enter] key.
3. Press the [↓] key to place the cursor on the field (channel) to change.
4. Do one of the following:
 - Editing channels:** Press the [Backspace] key to delete the channel number and then enter new channel number.
 - Adding channels:** Enter channel number on a blank line.
 - Deleting channels:** Delete group name with the [Backspace] key.
 - Disabling channels temporarily:** Press the [←] key to underline Pass.
5. Press the [Enter] key twice.

10 NBDP FILE OPERATIONS

This chapter mainly describes how to create, save, open, edit and print files. The Edit menu provides a full lineup of editing facilities, including search and replace.

10.1 Opening and Closing Files

To create a telex message you will need to make a new file, which you do with the File Open command. When you open a new file it is placed (opened) in one of two working areas. When both working areas are occupied you must close a file to open a new file. This is done with the File Close command.

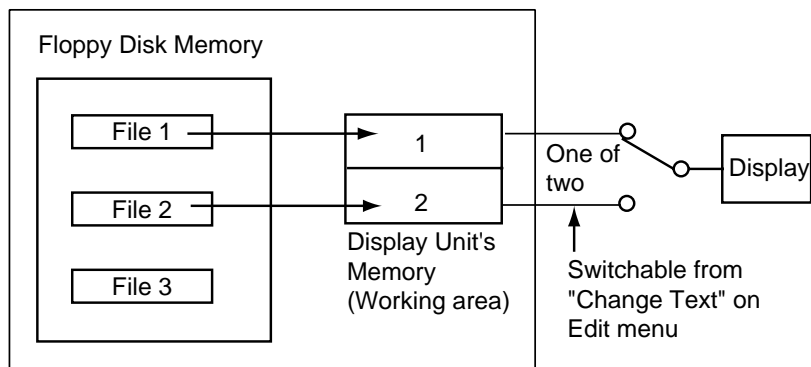

How a file is opened

10.2 Creating Files

1. Press the function key [F1] to display the File menu.



File menu

2. Press the [1] key to choose New. The title bar shows UNTITLED 1 or UNTITLED 2. The cursor marks the location where you may type text.

Note: When two working areas have been opened, the close confirmation window appears. See paragraph 10.3.2 below. In this case, choose Yes or No and press the [Enter] key to close an open file in order to open another file.

3. Type your message.

Note: Do not use lower case letters, or the symbols #, &, *, \$ and % in telex messages. Also, do not put “\$\$\$” in the middle of a TX message, but at the end. The communication line is automatically disconnected when this string is detected.

10.3 Saving a File

Use only 2HD type floppy disks. Insert floppy disk with care. Rough handling can destroy the information stored inside. To eject a disk, press the eject button on the right side of the floppy disk drive and then remove the disk. Do not eject a disk while the operating lamp is lit; the contents of the disk may become damaged.

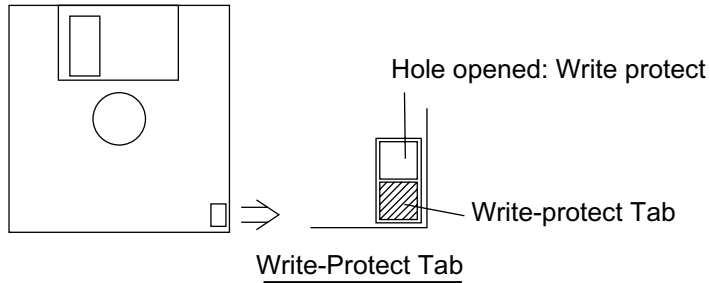

10.3.1 Formatting floppy disks

Before you can save a file to a floppy disk, the disk must be formatted. Formatting prepares the disk for use in the system.

1. Press function key [F1]. For the IB-583, insert a new floppy disk in the disk drive.
2. Press the [0] key to choose Floppy Disk Format.
3. Press the [↑] key to choose Yes.
4. Press the [Enter] key. For the IB-581, insert a new floppy disk in the drive.
5. Press the [Enter] key. For the IB-583, the screen shows formatting progress as below.



6. After the formatting has been completed, the following occurs:
IB-581: You are asked "Format another (Y/N)?" Press [N] and [Enter] to quit.
IB-583: Control is returned to the DSC standby screen.

10.3.2 Saving a file

1. Press the function key [F1] to display the File menu.
2. Press the [3] key. The screen should look something like the illustration at right.

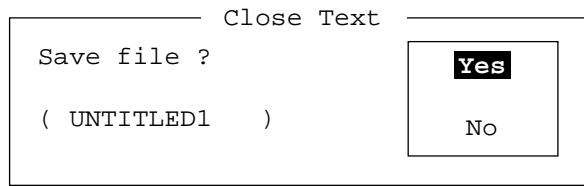

Close text screen

3. Yes is selected; press the [Enter] key. Enter file name, using up to eight characters. You may use any alphabet or numeric on the keyboard. But you may not use the symbols shown below. You may add an extension at the end of the file name, for example, .TXT, to distinguish text files from macro files.

| i : " > < ;

4. Press the [Enter] key.

10.4 Editing Files

10.4.1 Cutting and pasting text

You can delete, move and copy text by using the Cut, Copy and Paste functions in the Edit menu.

```

      Edit
-----
1: Undo
-----
2: Cut
3: Copy
4: Paste
-----
5: Select All
-----
6: Search
7: Replace
-----
8: Goto Top
9: Goto Bottom
0: Goto Line
-----
A: Change Text

```

Edit menu

Cutting text

1. Place the cursor on the first character of the text to be cut.
2. Highlight the text to be cut by pressing and holding the [Shift] key while pressing the [→]. If you highlight text which you do not want to cut, press the [←] to adjust the highlight.

```

      <[1]UNTITLED1>
-----
CONGULATULATION ON YOUR CHOICE OF DP-6
INMARSAT B MOBILE EARTH STATION.
WE ARE CONFIDENT THAT YOU WILL ENJOY MANY YEARS OF
OPERATION WITH THIS FINE PIECE OF EQUIPMENT

```

The highlight

3. Press the function key [F2] and the [2] key, or the [Delete] key. The highlighted text is cut and the remaining text is reformatted.

If you make a mistake, you can restore the text by immediately selecting Undo from the Edit menu.

Pasting text

To paste the cut text to a new location, do the following:

1. Place the cursor at the exact spot in the message where the cut text is to start.
2. Press the function key [F2] and the [4] key, or the [Insert] key.

10.4.2 Copying and pasting text

You may copy a portion of text and paste it elsewhere.

1. Choose the text to copy. (See "cutting text" above for the procedure.)
2. Press the function key [F2] and the [3] key.
The text selected is copied to the paste buffer memory where the cut or copied text is stored.
The display returns to the normal screen.
3. Place the cursor at the exact spot in the message where the copied text is to start.
4. Press the function key [F2] and the [4] key.

10.4.3 Select all

The Select All feature lets you select all of the file currently displayed. This feature can be useful when you want to combine files. The procedure below explains how to place the file loaded in working area 1 onto the end of the file loaded in working area 2.

1. Load the file to be copied from a floppy disk in working area 1.
2. Press the function key [F2] and the [5] key. The entire file appears in inverse video.
3. Press the function key [F2] and the [3] key. The file is placed in the paste buffer memory.
4. Load the file to be combined in working area 2.
5. Place the cursor at the exact spot in the message where the text now in the paste buffer memory is to start and press the [Insert] key.

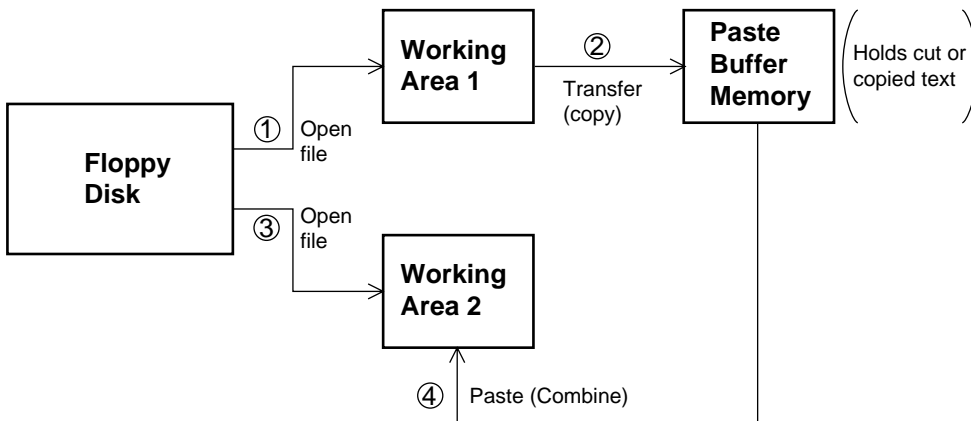

Copy and paste flow diagram

10.4.4 Searching text

The Search feature lets you search for text in a forward or backward direction.

1. Display a text and press the function key [F2] and the [6] key. The Search display appears.

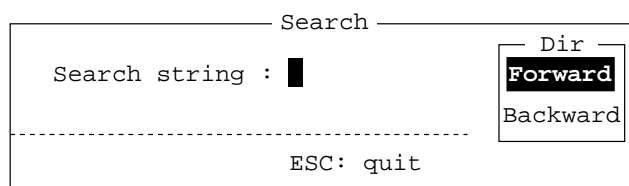

Search screen

2. Type the word you want to find. Use the Choose Forward or Backward to search the file in a forward or backward direction respectively from the cursor position. Press the [Enter] key to begin the search.

When the unit finds the word, the cursor stops at the first character of the word. Press the [Enter] key to continue the search. If the string could not be found, the message "Not Found (To quit: ESC)" appears. Press the [Esc] key to quit.

10.4.5 Replacing text

The Replace feature helps you replace every occurrence of a word or phase with another word or phase in a file.

1. Press the function key [F2] and the [7] key. The Replace display appears.

Replace	
Search string : █	Dir
Replace with : _____	Forward
-----	Backward
	Mode
	Query
	All
To quit: ESC	

Replace screen

2. Type the word you want to replace on the "Search string" line.
3. Press the [↓] key to choose "Replace with." Type the new word.
4. Use the [↑] or [↓] key to choose Forward or Backward to search the file in a forward or backward direction respectively from the cursor position.
5. Use the [↑] or [↓] key to choose whether you want to be queried or not each time the word is found.
 - Query:** Stop at each occurrence of word to answer yes or no to replacement.
 - All:** Replace every occurrence of word without stopping to confirm.
6. Press the [Enter] key to start the replacement.

10.4.6 Goto line

The Goto line feature places the cursor at the head of a line desired.

1. Press the function key [F2] and the [0] key. The following display appears.

Goto Line
Jump to Line No. : █ _____

Goto line screen

2. Key in line number and press the [Enter] key. The cursor shifts to the head of the line selected.

10.4.7 Goto top, Goto bottom

You can easily go to the top or bottom line of a file. Press [F2], [8] to go to the top line; press [F2], [9] to go to the bottom line. Note that this feature can also be executed on the editor screen by pressing the [Home] key while pressing the [Fn] key.

10.5 Opening Files

Two working areas (called working area 1 and working area 2) are provided to which you can load a file, and one file may be displayed on the LCD.

10.5.1 Opening a file

1. Insert the floppy disk which contains the file you want to open.
2. Press the function key [F1] to display the File menu.
3. Press the [2] key. A chronological list of files on the floppy disk appears.

```

----- Open Text -----
Load/Merge (TAB:Change)
[B:\TEST1. ]
-----File name-----Size-----Date & Time-----
LOG File           52    02-10-15 17:25
TEST1.           120    02-10-15 16:30
TEST2.             151    02-10-15  9:25
TEST3.             180    02-10-15 20:16
NBDP                169    02-10-15  6:23
[----- End of Directory-----]

4 Files exist                1454000 bytes free
-----
To select : ENTER  To view : SPACE  To quit : ESC

```

4. Use the [↑] or [↓] key to choose a file.
5. Press the [Enter] key.

The file appears and the title bar shows the file name. You may repeat this procedure to load another file into a working area.

Note: When two working areas have been opened, the close confirmation window appears. In this case, choose Yes or No and press the [Enter] key to close an open file in order to open another file.

10.5.2 Switching between files

Two files can be opened and one displayed on the LCD. To switch between files do the following:

1. Press the function key [F2].
2. Press the [A] key to switch between files.

10.6 Renaming Files

To rename a file, do the following:

1. Press the function key [F1].
2. Press the [5] key.
3. Use the [↑] or [↓] key to choose a file and press the [Enter] key.
4. Enter a new name.
5. Press the [Enter] key.

10.7 Saving a File Under a New Name

You may save a file under a new name as follows:

1. Open a file.
2. Edit the file as necessary.
3. Press the function key [F1].
4. Press the [3] key to save the file.
5. Press the [Y] key.
6. Press the [Backspace] key to erase the original name and then enter a new name.
7. Press the [Enter] key.

10.8 Deleting Files

Insert appropriate floppy disk in the drive and do the following to delete unnecessary files.

1. Press the function key [F1].
2. Press the [4] key.
3. Use the [↑] or [↓] key to choose the file to delete and then press the [Enter] key.
4. Press the [Enter] key again. (To cancel, press the [↓] key to select NO followed by the [Enter] key.)

10.9 Real Time Printing

An incoming or outgoing message can be printed out while it is being received or transmitted.

1. Press the function key [F1] to display the File menu.
2. Press the [6] key to turn real time printing on/off.

“Print” appears in reverse video at the top of the display.

10.10 Printing Files

You can print files stored on floppy disks as follows:

1. Press the function key [F1].
2. Press the [7] key.
3. Use the [↑] or [↓] key to choose a file and press the [Enter] key.
4. Press the [Y] key.

To stop printing at any time, press [F1] and [8] keys.

If the file could not be printed, "Cannot print. Check connection between printer and terminal. Press any key to escape." is displayed.

11 NBDP TRANSMITTING, RECEIVING

This chapter mainly shows you how to transmit and receive telex messages.

11.1 Manual Calling

NOTICE

Before calling, watch the intended TX frequency carefully to confirm that is unoccupied.

The simplest way to communicate with a telex subscriber is Manual Calling. For the ARQ mode, you may display beforehand the message to send, or type your message manually.

1. Press the function key [F3] to display the Operate menu.

```
      Operate
-----
1: Call Station
2: Macro Operation
-----
3: File to Send
4: Cancel Sending
-----
5: Scan (Start/Stop)
-----
6: Manual Reception
-----
7: Timer Operation
-----
8: Manual Calling
9: Set Frequency
```

Operate menu

2. Press the [9] key to choose Set Frequency.

```
      Set Frequency
-----
Tx Freq: 0.00
Rx Freq: 0.00
```

Set frequency screen

3. Input Tx and Rx frequency pair.
4. Press the [Enter] key.
5. Press the function key [F3] again and then the [8] key to choose Manual Calling. The following screen appears.

```

Manual Calling
Mode : ARQ FEC
ID   :

```

Manual calling screen

6. Use the [←] or [→] key to choose appropriate communication mode.
7. Press the [↓] key and input party's ID number.
8. Press the [Enter] key to connect the communication line. "Channel Busy Check" appears to inform you that the equipment is checking if the line is busy. If the line is free, "Connect", "Send" and "Lock" appear in highlight as below. Further, "HT" (High Tension) also appears when the line is connected.

```

1:File 2:Edit 3:Operate 4:Window 5:Station 6:System 7:WRU 8:HR 9:Over 10:Break
----- 2002-09-08 2:14:28 UTC -----Caps-Eng
Station Name      :
Frequency (T/R)  : 8765.00 / 8965.00(kHz)  Comm Mode :ARQ
Comm Status      : Connect Send Lock Error
Sending Volume   : 100(%)  ARQ Error : 0  ARQ Time : 0(sec)
-----

```

For ARQ mode, go to step 9. For FEC mode, type your message and go to step 13.

9. Press the function key [F7] (WRU). The party's answerback code appears on the screen.

Note: Step 9 and 10 are needed for ship-to-ship calling only.

10. Press the function key [F8] (HR). Your ship's answerback code is sent to the party.
11. Press the [Enter] key and type your message.
12. If you want to receive other party's response, press the function key [F9] (Over).
13. Press the function key [F10] (Break) to disconnect the line.

11.2 ARQ Mode Operation

In ARQ operation, one station (information sending station) sends data to another block by block, then listens for the acknowledge signal between blocks from the information receiving station which requests either the next block or retransmission of the last block if there is error. The request may be repeated up to 32 times, until the complete block is received free of error.

Establishing connection

1. Press the function key [F3] to display the Operate menu.

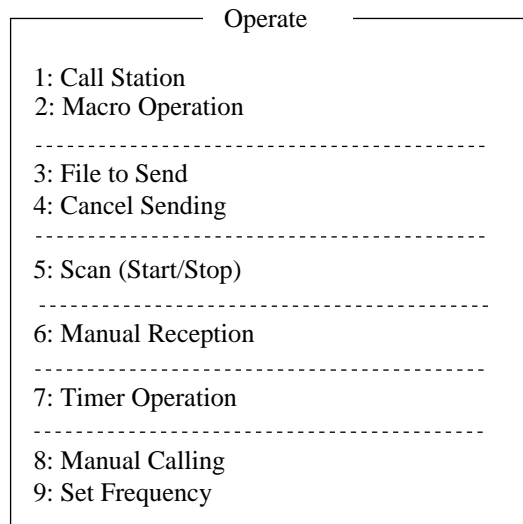

2. Press the [1] key to choose Call Station.

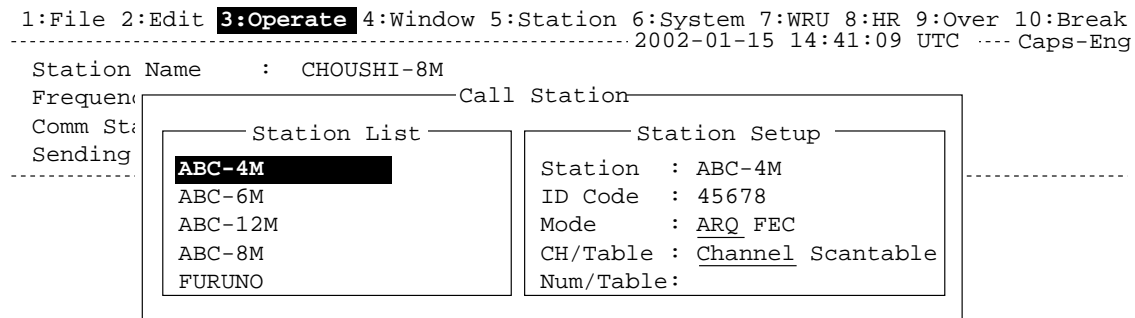

Call Station menu

3. Choose a station. (Station must be registered for use in the ARQ mode). Press the [Enter] key. The message "Calling Station" appears. If the message "Station calling suspended. Check radio and interconnections. Press any key to escape." appears, check both the power of the radiotelephone and the connections between the radiotelephone and the NBDP Terminal Unit.
4. When an acknowledge signal is detected, "Connect" appears in reverse video on the communication status display (see below).

Note: If signal conditions are poor, connection may take a while. If the line could not be connected in one minute, calling stops and "Calling failed" appears. Try step 3 again, one minute later. Should signal conditions worsen during message transmission, "Error" appears in reverse video and 30 seconds later the line is disconnected.

5. Transmit message by one of the following methods:

Sending a file stored on a floppy disk

- Press the function key [F7] (WRU) to receive the answerback code of the other station. Verify that the code from the station called is correct.
- Press the function key [F8] (HR) to transmit your own identity (answerback code).
- Press the function key [F3] and then the [3] key to display the Send screen. Choose file to send and press the [Enter] key. Press the [Enter] key again, and "Send" appears in reverse video while the file is being transmitted.

Send File		
File name	Size	Date & Time
LOG File	52	02-10-15 17:25
TEST1.	120	02-10-10 16:30
TEST2.	151	02-10-11 09:25
TEST3.	180	02-10-11 20:16
NBDP	169	02-10-12 06:23
[----- End of Directory -----]		
4 Files exist		1454000 bytes free
To select : ENTER To view : SPACE To quit : ESC		

Send file screen

Sending volume (percentage of message transmitted, counts upward as the message is being transmitted), ARQ error count and ARQ transmission time appear on the display. "Lock" appears in reverse video when the mark and space signals in the receive signal are normal. "Sending Volume" shows what percentage of the message has been sent. "ARQ Error" shows the number of times error was found during transmission. "ARQ Time" is the time in seconds the communication line has been established.

```
1:File 2:Edit 3:Operate 4:Window 5:Station 6:System 7:WRU 8:HR 9:Over 10:Break
----- 2002-09-08 2:14:28 UTC -----Caps-Eng
Station Name      :                               HT
Frequency (T/R)   : 8765.00 / 8965.00(kHz)  Comm Mode :ARQ
Comm Status       : Connect Send Lock Error
Sending Volume    : 100(%)  ARQ Error : 0  ARQ Time : 0(sec)
-----
```

Communication status display

Type a message from the keyboard

After exchanging answerback code by the function key [F7] (WRU) and [F8] (HR), type your message directly from the keyboard.

- To change direction of traffic, press either function key [F9] (OVER), or [+] and [?]. Then, the other station becomes the information sending station, your station the information receiving station.
- Receive a message from the sending station, if any.
- After completion of communication, press the function key [F7] (WRU) key to receive the answerback code of the other station and then press the function key [F8] (HR) to transmit your own answerback code.
- Press the function key [F10] (Break) to disconnect the line.

Stopping transmission

1. Press the function key [F3] and then the [4] key. "Canceled Sending" appears on the screen. Transmission is stopped but the line is still connected.
2. To disconnect the line, press the [F10] key.

11.3 FEC Mode Operation

The FEC mode transmits the same data twice to yield less errors. Compared to the ARQ mode, the FEC mode is better at communicating with weak signals.

1. Press the function key [F3].
2. Press the [1] key to display the Call Station menu.
3. Choose a station which is registered for the FEC mode. Press the [Enter] key. "CONNECT" appears in reverse video.
4. Transmit a message directly from the keyboard, or do the following to transmit a message stored on a floppy disk:
Press the function key [F3] and the [3] key to choose File to Send. Choose file to send and then press the [Enter] key.
5. After the message is transmitted, press the function key [F10] (Break) to disconnect the line.

11.4 Choosing Receive Mode

1. Press the function key [F3] and then the [6] key.
2. Choose receive mode:
 - AUTO:** Automatic reception in ARQ or FEC mode
 - ARQ:** International radiotelex ARQ mode
 - FEC:** International radiotelex FEC mode
 - DIRC:** Receive message from teleprinter
3. Press the [Enter] key. The reception mode appears on the screen.

All received (and transmitted) messages are saved to a floppy disk when "TX/RX Msg Save" is ON in the System menu. The file is automatically named as follows.

02	01	13	0	0.	X	X	X
↑	↑	↑			↑		
Year	month	date			Serial number from 000		

11.5 Communication Example

Call the coast station following the procedure in paragraph 11.2. Then, communicate with the coast station. Below is a communication example.

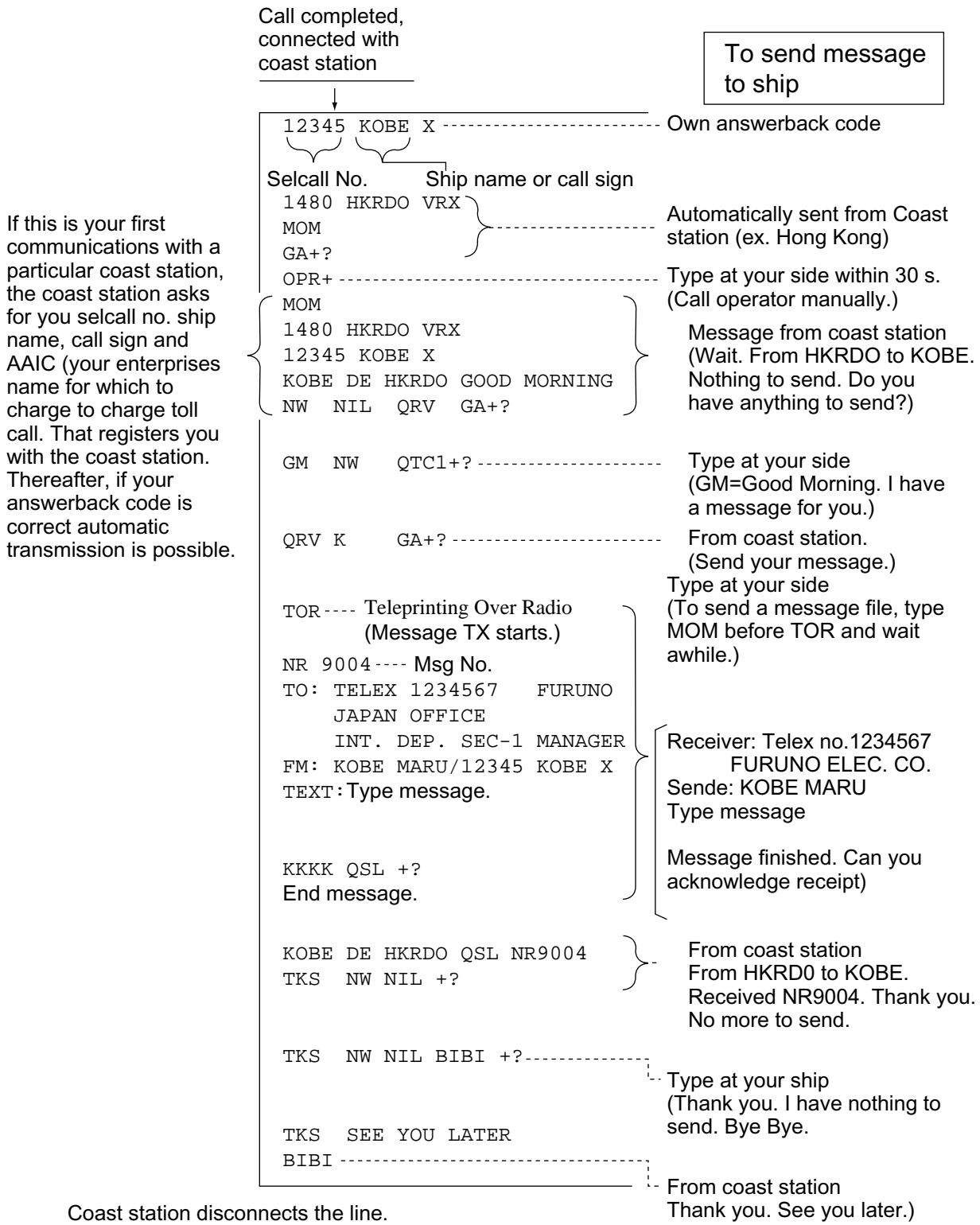

Communications example

Table of abbreviations

Abbreviation	Question	Answer or Advice
QRA	What is the name your station?	The name of my station is
QRC	By what private enterprise are the accounts for charges for your station settled?	The accounts for my station are settled by the private enterprise
QRU	Have you any thing for me?	I have nothing for you.
QRV	Are you ready?	I am ready.
QRX	When will you call me again?	I will call you again at hours [on kHz].
QSJ	What is the charge to be collected to . . . including your internal charge?	The charge to be collected to including my internal charge is frans
QSL	Can you acknowledge receipt?	I can acknowledge receipt.
QSX	Will you listen to [call sign] on kHz?	I am listening to [call sign] on kHz.
QTA	Shall I cancel message number ?	Cancel message number
QTC	How many messages have you to send?	I have message for you.
QTU	What are the hours your station is open?	My station is open from to hours.
Abbreviation	Definition	
BK	Signal used to interrupt a transmission progress.	
CFM	Confirm	
DE	"From "	
K	Invitation to transmit.	
NIL	I have nothing to send to you.	
NW	Now	
PSE	Please	
R	Received	
REF	Reference to	
SVC	Prefix indicating a service telegram.	

Command and abbreviation

Command	Function
TGM+	To indicate that the following message is a radiotelegram.
MSG+	To indicate that the ship station needs to be connected immediately any message held.
OPR+	Call operator.
URG+	Safety, urgency and distress message.
MED+	Request medical advice.
TEST+	Request coast station to send a test message for checking the ship station.
BRK+	To clear the connection with the coast station.
Abbreviation	
GA+	I am ready. Transmit your command.
MOM	Wait a moment.
MSG+	Request pending messages from the shore.
KKKK or NNNN	Terminate a message.

11.6 Timer Operation

A built-in timer permits automatic transmission and reception of telex messages.

11.6.1 Enabling timer operation

1. Press the function key [F3] to display the Operate menu.
2. Press the [7] key to display the Timer Operation List.
3. Choose the operation (name) you wish to execute. Press the [Enter] key. An asterisk appears beside the operation selected and "T. Op" appears in reverse video on the communication status display. If a file stored on a floppy disk is to be sent, be sure the floppy disk containing the file is inserted in the drive.

```

Timer Operation List
*1
2
3
OP4
OP5

```

Timer operation list

4. Choose another operation (name) if desired.
5. Press the [Esc] key.

When the predetermined time comes, the NBDP Terminal Unit automatically sends or receives the message. The results of timer operation are displayed as either OK or NG (No Good) on the Timer Operation List.

Timer Operation List	
*1	OK
2	
*3	OK
*OP4	OK
*OP5	NG

Timer operation list

11.6.2 Stopping timer operation

1. Press the function key [F3].
2. Press the [7] key.
3. Choose the operation (name) which has an asterisk attached to it and then press the [Enter] key. Remove all asterisks to cancel all timer programs.

11.7 Scanning

The radio equipment scans a group of operator-selected frequencies (channels), and stops scanning when a signal is received. For registering scan group, see paragraph 9.5.

1. Press the function key [F3] and then the [5] key to show the Scanning Group List on your screen.
You can confirm the scan channel by pressing the [↑] or [↓] key while pressing the [Shift] key.

Scanning Group List	
1	
2	
3	

Scanning group list

2. Choose a scan group and press the [Enter] key.
3. The scanning starts and the indication "Scan" appears in reverse video. Further, the name of the scan group appears in the Station Name field.

```

1:File 2:Edit 3:Operate 4:Window 5:Station 6:System 7:WRU 8:HR 9:Over 10:Break
-----2002-09-08 2:01:46 UTC -----Caps-Eng
Station Name      : SAITO-1          Scan          HT
Frequency (T/R)  : 8344.00 / 8705.00(kHz)  Comm Mode : Auto
Comm Status      : Connect Send Lock Error
Sending Volume   : 100(%)  ARQ Error : 0  ARQ Time : 0(sec)
-----

```

Communication status display

4. To stop scanning, press the function key [F3] and then the [5] key. "Scan" appears in normal video on the communication status display.

11.8 Communication Buffer

The communication buffer is a temporary memory which stores transmit and receive messages. To display the contents of the communication buffer, do the following:

1. Escape from the message creation screen.
2. Press the [PgDn] or [PgUp] key. The contents of the communication buffer are displayed.

To print them, press the [Ctrl] and [P] keys simultaneously. To erase the contents from the screen, press the [PgDn] key while pressing the [Fn] key.

To erase the contents of the buffer, press the [F1] and [9] keys.

11.9 Preparing Macrofiles for Automatic Telex

11.9.1 Automatic telex overview

This section shows you how to communication with a coast station which handles automatic telex transmission, using macrofiles. You will also need to register communication channels and stations, and prepare macrofiles.

Coast stations using automatic telex are MCI Marine Services (North America), Sydney Radio (Australia), Lyngby Radio (Denmark), and others. The procedure is mostly common to all coast stations, however refer to the coast station's traffic manual for details.

INTERNATIONAL
TELEX NETWORK

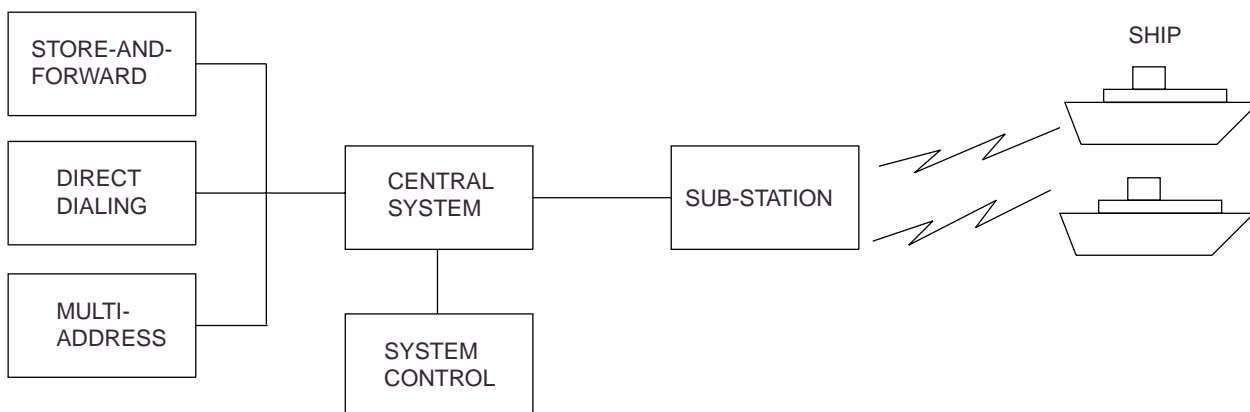

Sample automatic telex network

The service available in automatic telex are

- Message transfer between ship and coast station (store-and-forward)
- Connection with landline telex (direct dialing)
- Multi address.

11.9.2 Preparations

To use automatic telex, you will need to register three items:

- Answerback code
- Scan groups
- Station names

Registering answerback code

The coast station assigns a Telex number. This number functions as an answerback code. An answerback code contains the following:

OOOOO SHIP X

OOOOO: Coast station-assigned five-digit telex code

SHIP: Ship name

X: For shipboard station, normally X is entered.

The procedure for registering the answerback code is the same as which appears on page 9-1. If an answerback code was registered before the commissioning of the coast station, a new answerback code must be entered. To enter a new answerback code, contact FURUNO or an authorized FURUNO agent or dealer.

Registering scan groups

The central system emits a free-signal to indicate a coast station radio channel is in idle condition and available for ship-to-shore calls. The free-signal is detected and recognized by the shipboard equipment as a permission to start the transmission. Then, the shipboard operator initiates a call.

You can scan search for the free-signal automatically by registering coast station radio channels in scan group(s). The procedure for registering scan groups for coast station use is the same as that which appears on page 9-7.

Registering stations

The next step is to enter station name. The procedure is the same as that shown on page 9-3.

11.9.3 Commands

The tables which follows describe the commands for macro operation

Command (Prefixed with @)	Parameter	Content
CALL	S: Station Name	Calling station name and ID on assigned parameter
FREE (support command for CALL)	Two digits, 0-99 min.	Free-signal searching time according to assigned parameter (default setting: 10 min)
	\$RRR\$ signal	Detect free signal of dot pattern
RETRY (support command for CALL)	Two digits, 0-99 min.	Calling according to assigned parameter (default setting: 10 min)
CASE	Text	For receiving a message (designated by parameter) transmitted by coast station
TIMEOUT (support command for CALL)	Two digits, 0-99 min.	Time allotted for reception of message by CASE command
SEND	Text	Text transmitted according to assigned parameters
	B file name (IB-581) A:\ file name (IB-583)	Send a file from floppy disk
WRU HR OVER BREAK	None	Function keys F7 – F10
DISPLAY	Text	Text of message appears
INPUT	None	Waiting for keyboard input Transmit keyboard input message

Commands processed by Danish coast station Lyngby

Command	Function
BRK+	Disconnection communications line
DIRTLX+	Direct dialing telex (receive only)
KKKK	Terminate message
LTR+	For telex letters mailed from Operations Station to destinations worldwide
MED+	Request medical advice
OPR+	Requesting operating assistance
POS+	Send position data
STA+	Status requested on a store-and-forward message
TLX+	Store-and-forward method

For details, consult the coast station's traffic manual.

11.9.4 Store-and-forward method

The following is the sequence of events in transmission of a file by the store-and-forward method.

1. Shipboard station sends message to coast station.
2. Coast station stores message in memory buffer.
3. Shipboard station and coast station clear the radio circuit.
4. Coast station sends message to subscriber designated.

Actual procedure for store-and-forward telex

<u>No.</u>	<u>Procedure</u>	<u>Display</u>	<u>Remarks</u>
1	Call a coast station.	CONNECT appears in reverse video (and bell sounds).	Free-signal found; radio circuit ready.
2	Transmit WRU signal.	00190 TLG DK 26 X X X SHIP X GA+?	Initial identity exchange between coast station and shipboard station
3	Key in subscriber's Telex number. Example: (Hong Kong) 12345		
	TLX80212345+	MSG+?	Request to start message transmission
4	Transmit file.		Message transmission
5	When transmission is completed, type KKKK.	26 X X X SHIP X 00190 TLG DK GA+?	Transmit your answerback code. Receive other party's answerback code.
6	Transmit BREAK command to clear radio circuit.		

Procedure for preparing a macrofile for store-and-forward method

You will need a macrofile to enable automatic message transmission by store-and-forward method. After preparing it, save it to a floppy disk for future use.

1. Press function key [F1] to display the File menu.
2. Press the [1] key.
3. Prepare macrofile. Below is simple example.

```

< [1] UNTITLED1 >

@FREE $RRR$ ----- ①
@CALL S:LYNGBY RADIO ----- ②
@WRU
@CASE GA+?
@SEND TLX80212345+ ----- ③
@CASE MSG+?
@SEND B: ABC ----- ④
@SEND KKKK ----- ⑤
@CASE GA+?
@SEND BRK+
    
```

- ① Search dot pattern free signal until it is found
- ② Station name (Example: LYNGBY RADIO)
Who are you?
Station identity exchange
- ③ Subscriber's Telex number (in example, 802 is country code of Hong Kong) for store-and-forward method
- ④ Location and name of file message
B: ABC (IB-581), A:\ABC (IB-583)
- ⑤ Request for termination of message

Sample macrofile for store-and-forward method

4. Press function key [F1] to display the File menu.
5. Press the [3] key. The Close Text appears on the display.

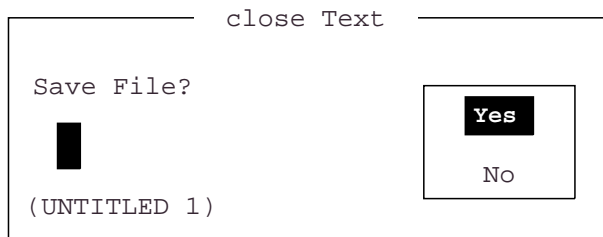

Close text prompt

6. Press the [Enter] key and enter a file name as follows:

OOOOOOOO.MCR

↑ ↑

File Name Extension Name

(max. 8 characters)

7. Press the [Enter] key.

DIRTLX macrofile

Sample DIRTLX macrofile

@FREE \$RRR\$	-----	①
@CALL S: LYNGBY RADIO	-----	②
@WRU		
@CASE GA+?		
@SEND DIRTLX725644325+	-----	③
@CASE MSG+?		
@SEND B: ABC	-----	④
@SEND KKKK	-----	⑤
@CASE GA+?		
@SEND BRK+		

- ① Search dot pattern free signal until it is found
- ② Station name (Example: LYNGBY RADIO)
Who are you?
Station identity exchange
- ③ Subscriber's Telex number (in example, 72 is country code of JAPAN) for direct dialing mode
- ④ Location and name of file message
B: ABC (IB-581), A:\ABC (IB-583)
- ⑤ Request for termination of message

Sample DIRTLX macrofile

Procedure for DIRTLX

<u>No.</u>	<u>Procedure</u>	<u>Display</u>	<u>Remarks</u>
1	Call a coast station.	CONNECT appears in reverse video (and bell sounds).	Free-signal found; radio circuit ready.
2	Transmit WRU signal.	00190 TLG DK 26 X X X SHIP X GA+?	Initial identity exchange between coast station and shipboard station
3	Key in subscriber's Telex number. Example: (Japan) 5644325		
	DIRTLX725644325+	12:20 MOM 5644325 FURUNO J MSG+	Request to start message transmission
4	Transmit file.		Message transmission
5	When transmission is completed, type KKKK.	26 X X X SHIP X 5644325 FURUNO J 00190 TLG DK DURATION ... TIME ... GA+?	Transmit your answerback code. Receive other party's answerback code.
6	Transmit BREAK command to clear radio circuit.		

11.10 Automatic Telex using Macrofile

This section describes how to transmit a telex message using a macrofile.

Basic procedure

1. Register answerback code (Telex number assigned by coast station).
2. Register coast station frequency and channel to scan group.
3. Register station name including scan group name.
4. Retrieve appropriate macrofile. Include station name and message file name. Type message and save file to memory.
5. Open macro operation menu and select a macrofile. (See next page for details.) Your message will be transmitted automatically. Below is the sequence of automatic message transmission to a coast station.
 - a) Search for free-signal
 - b) Call coast station on one of its radio channels
 - c) After connection is established, identity exchange
 - d) Transmission of service category and subscriber's address
 - e) Transmission of message
 - f) Transmission of termination of message signal
 - g) Identity exchange
 - h) Clearing of radio circuit

Actual procedure

1. Press function key [F3] to display the Operate menu.

Operate

1: Call Station
2: Macro Operation

3: File to Send
4: Cancel Sending

5: Scan (Start/Stop)

6: Manual Reception

7: Timer Operation

8: Manual Calling
9: Set Frequency

Operate menu

2. Press the [2] key to display the Call Macro screen.

```

Call Macro
[A:\... for IB-583] [B:\TEST1.]
-----File name-----Size-----Date & Time-----
LOG File           52    02-10-15 17:25
TEST1.           120    02-10-10 16:30
TEST2.             151    02-10-11 09:25
TEST3.             180    02-10-11 20:16
LYNGBY1.MCR       169    02-10-13 06:23
[----- End of Directory----- ]

4 Files exist                1454000 bytes free
-----
To select : ENTER  To view : SPACE  To quit : ESC

```

Call macro screen

3. Press the [↓] key to choose a macrofile.
4. Press the [Enter] key.

```

Call Macro: Lyngby1.MCR
Call OK?
Yes
No

```

5. Press the [Enter] key to confirm the macrofile selected. The Wait for Free Signal indication appears. Your message will be transmitted automatically.

12 MAINTENANCE & TROUBLESHOOTING

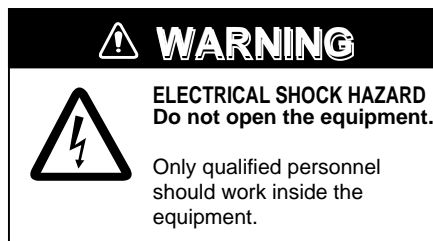

12.1 Daily Test

Authorities require that the DSC/watch receiver be checked daily for proper operation to ensure that it will function properly in the event of distress. Execute the daily test as below.

1. At the DSC standby screen, press the [3/TEST] key to start the test.
2. After several seconds the test results, OK, for normal operation, NG for No Good. For NG (No Good) contact your dealer for advice.

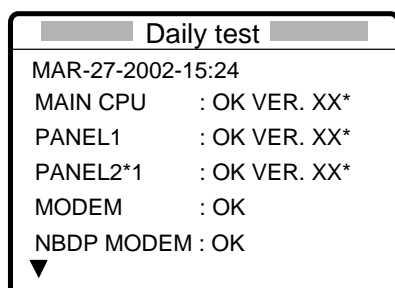

Page 1

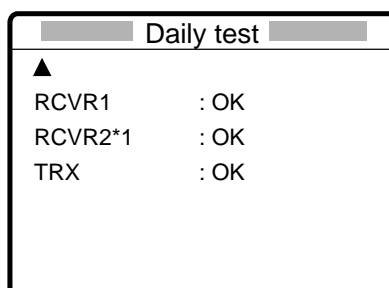

Page 2

*: XX = Version No.

*1: Shown if equipped with No. 2 control unit.

Test results

3. After the test results for the items on page 2 appear, the audio alarm sounds, the ALARM lamp flashes several times and then page 1 of the daily test is displayed.

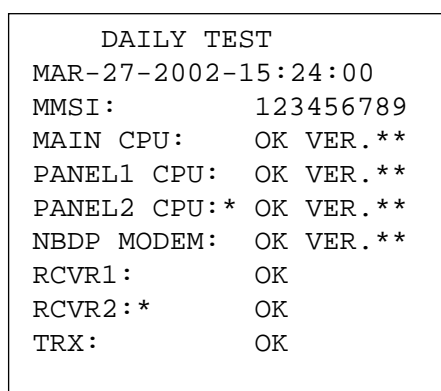

* = PANEL2 CPU, RCVR2 printed if equipped with no. 2 control unit.

** = Version No.

4. If auto printing is active, the test results are printed. To manually print the test results, press the [8/PRINT] key. Above is a sample test results printout.
5. Press the [CANCEL] key to quit the test and return to the DSC standby screen.

Note: TEST on the DSC Setup menu is for used by service technicians.

12.2 Radiotelephone Test

Do the following to check the radiotelephone for proper operation:

1. At the radiotelephone screen, press the [3/TEST] key to start the test. OK or NG (No Good) appears as the test result for each item checked. For NG, contact your dealer for advice.

Tx selfcheck	
PLL : OK	PA2 : OK* * FS-2570 only
	COMB : OK*
RF : OK	TX FIL : OK
PA1 : OK	COUPL : OK

2. Press the [CANCEL] key to quit the test and return to the previously used screen.

12.3 Antenna Coupler Test

The CPU and the relays which choose capacitors and coils for tuning can be checked. For qualified technicians only.

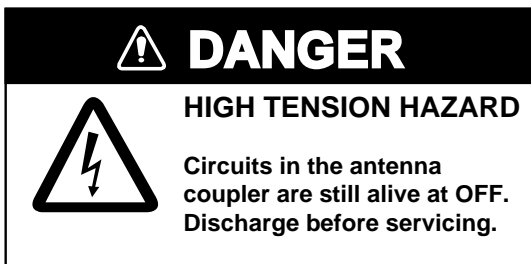

1. Open the antenna coupler cover.
2. Open the shield cover inside the coupler.
3. Turn on the #2 switch of DIP switch S2.
4. Press the TUNE switch in the antenna coupler.
5. 24 LEDs (CR1 to CR24) light one by one every second. Relays trip on with corresponding LEDs as below.

CR1 ON – K1 ON

CR2 ON – K2 ON

.

.

.

CR22 ON – K22 ON (CR23 not provided)

CR24 ON – K24, K25 ON

6. Turn off the #2 switch of DIP switch S2.

7. Close the cover.

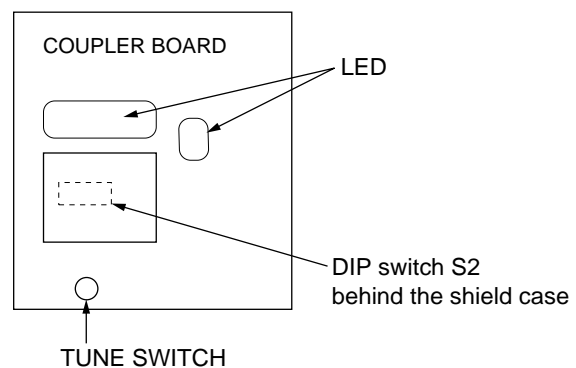

If CPU error is detected, CR1 lights for ROM error, CR2 for RAM error, CR3 for A/D converter error. (ROM/RAM/ A/D converter is incorporated in the CPU.)

12.4 Maintenance

Regular maintenance is vital for maintaining performance. Following the procedures below will help keep the equipment in top operating condition.

Maintenance check points

Item	Check Point	Remedy/Remarks
Antenna	Check for physical damage and corrosion.	Replace damaged parts.
Wire antenna	Check that the antenna is properly spanned and separated sufficiently from metallic structures.	If necessary, re-span antenna.
Insulators for antenna	Check for salt water deposits on insulators. Check that connection at the lead-in insulator is tight and rust-free.	Replace damage insulators. Remove salt water deposits. Clean with fresh water, then dry. Remove rust, then tighten bolts and lock nuts. Cover metallic surface with sealing compound.
Antenna coupler	<ul style="list-style-type: none"> • Check condition of antenna terminal, ground, coaxial cable and control cable. • Check that coupler lid and cable glands are firmly secure. • Check for physical damage, corrosion and salt water deposits. 	<ul style="list-style-type: none"> • Tighten loosened connections. • Fasten lid firmly and evenly to prevent water leakage. • Replace if damaged.
Control unit	<ul style="list-style-type: none"> • Check ground connection, control cable, and external equipment. • Confirm that there are no objects on the top of the control unit. • Remove dust from control unit with soft cloth. <p>Note: Do not use chemical cleaners to clean the display unit; they can remove paint or markings or deform the equipment.</p>	<ul style="list-style-type: none"> • Tighten loosened connections; remove foreign material from connectors. • Remove any objects. • Wipe the LCD carefully to prevent scratching, using tissue paper and an LCD cleaner. To remove dirt or salt deposits, use an LCD cleaner, wiping slowly with tissue paper so as to dissolve the dirt or salt. Change paper frequently so the salt or dirt will not scratch the LCD.
Transceiver unit	<ul style="list-style-type: none"> • Check connection at signal cable, coaxial cable, control cable, power cable, and navigator. • Confirm that there are no objects on the top of the cabinet. 	<ul style="list-style-type: none"> • Tighten loosened connections; remove foreign material from connectors. • Remove any objects.
Power supply	<ul style="list-style-type: none"> • Check that the supply voltage at transmission is within the rated range (21.6 to 31.2 VDC at the power connector). 	<ul style="list-style-type: none"> • If not within the range, call for service. Low voltage may cause erratic operation.

12.5 Replacement of Fuses

To protect the FS-1570 from overcurrent and equipment fault, two fuses are provided in the PR-300 Power Supply Unit. If a fuse blows, find the cause before replacing it. If it blows again after replacement, request service.

 CAUTION
<p>Use the proper fuse.</p> <p>Use of the wrong fuse can cause serious damage to the equipment and void the warranty.</p>

Unit	Fuse
Power Supply Unit PR-300	10 A (100 VAC) or 5A (200 VAC) and 20 A (24 VDC)

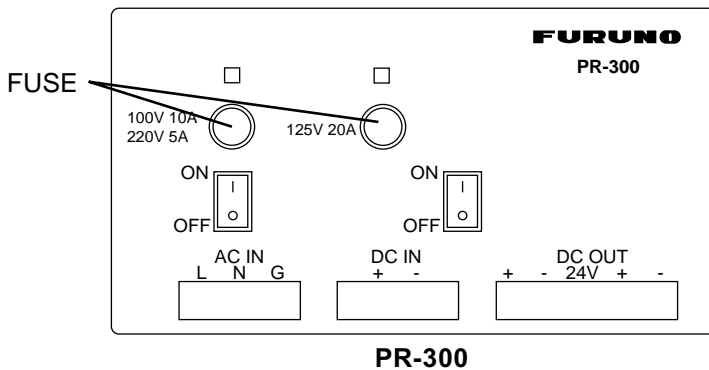

Note: The Power Supply Unit PR-850A, used with the FS-2570, does not have a fuse but a circuit breaker. If the breaker has tripped, find the reason before resetting the breaker (upward position).

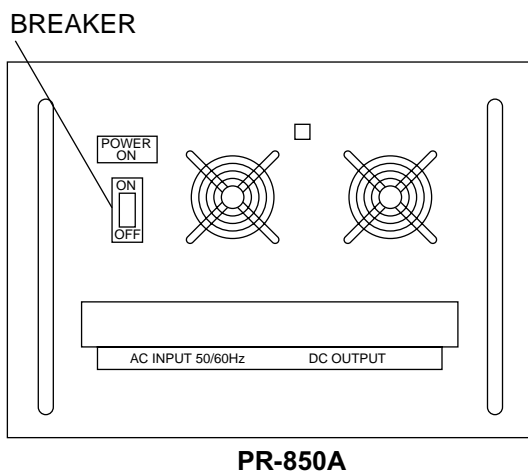

12.6 Simple Troubleshooting

The table below provides common problems and the means with which to restore normal operation. If normal operation cannot be restored, do not attempt to check inside the equipment. Any servicing should be referred to a qualified technician.

Problem	Probable cause	Remedy
Power cannot be turned on.	<ul style="list-style-type: none"> • Mains switchboard may be off. • (DC) voltage is too high. • Battery may have discharged, or poor contact at terminals. 	<ul style="list-style-type: none"> • Turn on the mains switchboard. • Check supply voltage. • Recharge battery and tighten battery terminals.
Display indications do not appear but key lamps are lit.	<ul style="list-style-type: none"> • Contrast is too low. 	<ul style="list-style-type: none"> • Operate the [9/☉] key to adjust contrast.
Power is on but no sound from loudspeaker.	<ul style="list-style-type: none"> • Loudspeaker is off. 	<ul style="list-style-type: none"> • Operate the [7/🔊] key to turn on the loudspeaker.
Poor articulation	<ul style="list-style-type: none"> • Wrong class of emission may be in use. 	<ul style="list-style-type: none"> • Class of emission should match that of incoming signal.
Output power reduced to LOW	<ul style="list-style-type: none"> • Power is automatically reduced to protect against overheating due to continuous transmission. 	<ul style="list-style-type: none"> • Wait until the unit returns to normal condition.
Antenna coupler cannot tune antenna	<ul style="list-style-type: none"> • Antenna may be disconnected or shorted to ground. • Antenna is out of tunable length. • Poor grounding of antenna coupler. • Breaker in coupler has tripped. • Connection cable loosened or disconnected. 	<ul style="list-style-type: none"> • Check antenna connection. • Recommended length is 7 to 30 meters. • Check coupler ground. • Checks mains voltage and polarity. If normal, reset breaker. • Check cable.

12.7 Error Messages

The table below shows error messages and their meanings.

Error messages

Error message	Meaning	Remedy
Busy: RT	Radiotelephone is in operation.	Wait until the radiotelephone is free.
Channel Busy	You attempted to transmit on a channel which is currently busy. (This occurs with	The message is automatically erased when the channel becomes clear.

	Routine and Business priorities only.)	
EPFS error	No position data from navigator for one minute.	Press the [CANCEL] key to silence the alarm. Check the navigator. If it is malfunctioning, manually enter position.
Incoming	Incoming DSC call	Message is automatically cleared when DSC signal has gone.
No position data	You attempted to enter position automatically when there is no position data.	Check the navigator.
No response: RT	Radiotelephone not powered or has been disconnected.	Check radiotelephone.
Oven cold. Tx not ready; wait	Oven too cold; cannot transmit.	Wait until the oven becomes sufficiently warm.
Printer not ready	Automatic printed has been selected; however, printer is not powered or has been disconnected.	Check printer.
Trouble: Oven not ready	Oven not ready; cannot transmit.	Wait until the oven is ready.
TRX PLL UNLOCK	TRX PLL unlock. Transmission is stopped.	Check if the reference oscillator is working and the coaxial cable is tightly connected.
TUNE error	Tuning failed for DSC or NBDP. Transmission (except distress) is stopped.	Try to tune again.
Warning: Update position	Position data is older by the amount of time preset on the Alarm menu.	Press the [CANCEL] key to silence alarm. Reenter position on the Position menu.
Watchdog error. Please Power OFF	Internal error (such as CPU trouble) detected. Accompanied with alarm, same type as for distress.	Turn the power off and on to erase the message. Have a qualified technician check the set.
WR1 PLL UNLOCK WR2 PLL UNLOCK	WR1, WR2 PLL unlock. Transmission is stopped.	Check if the reference oscillator is working and the coaxial cable is tightly connected.

12.8 Test Call

This function sends a test signal to a coast station, over one of six distress and safety frequencies. For that reason, it should not be executed unnecessarily. You can prepare a test call beforehand (see Chapter 6) or at the moment you intend to send a test call. To send a prepared test call, see page 6-9 for the procedure.

1. Press the [2/DSC] key at the DSC standby screen and then push the [ENTER] knob to open the CALL TYPE menu.

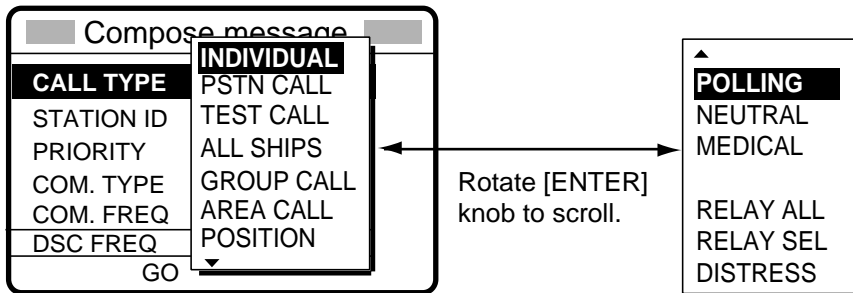

2. Rotate the [ENTER] knob to choose TEST CALL and then push the [ENTER] knob.
3. Push the [ENTER] knob to open the COAST ID menu.

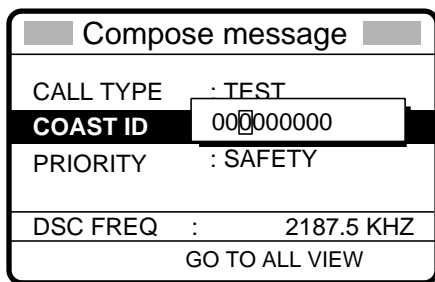

4. Using the numeric keys, key in the ID of the coast station ID (seven digits) where to send the call and then push the [ENTER] knob.
5. Push the [ENTER] knob to open the DSC FREQ menu. (Note that PRIORITY is automatically selected to SAFETY.)

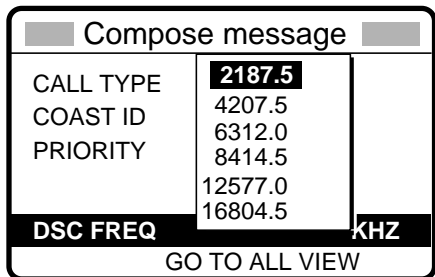

6. Rotate the [ENTER] knob to choose an appropriate frequency and then push the [ENTER] knob. The display changes as below.

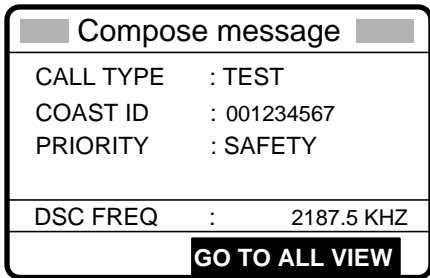

7. Press the [CALL] key to send the test call (transmission time: about seven seconds). The display shows "Test call in progress!" while the test call is being transmitted.

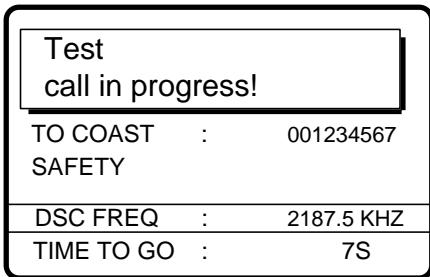

8. After the test call has been sent, the following message appears.

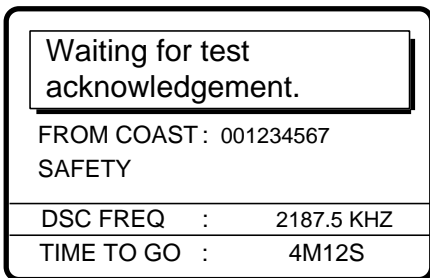

9. One of the following displays appears. ("No response! Try calling again?" appears when the timer counts down to zero, meaning no response from coast station.)

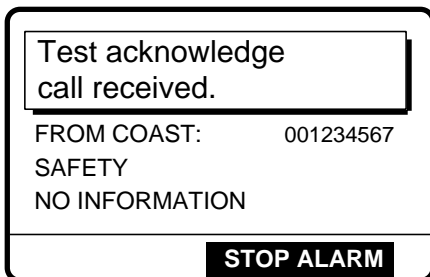

Test acknowledge received

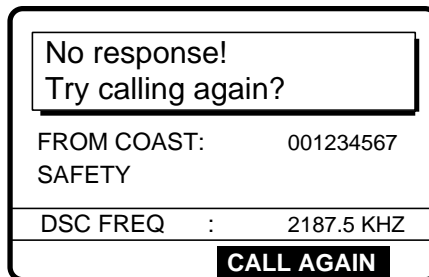

No response to test call

10. Do one of the following depending on the message shown in step 9.

Test acknowledge call received

The audio alarm sounds; press the [CANCEL] key to silence the alarm. The display changes as below.

**No response! Try calling again?**

Re-send call: Push the [ENTER] knob and then press the [CALL] key.

Cancel call: Press the [CANCEL] key to return to the DSC standby screen.

12.9 NBDP Terminal Unit Maintenance

Regular maintenance is important for good performance. A regular maintenance program should be established and should at least include the items mentioned below.

12.9.1 Cleaning the equipment

Wipe of accumulated dust from the terminal unit with a soft cloth. Wipe the LCD carefully to prevent scratching, using tissue paper and an LCD cleaner. To remove dirt or salt deposits, use an LCD cleaner, wiping slowly with tissue paper so as to dissolve the dirt or salt. Change paper frequently so the salt or dirt will not scratch the LCD. Do not use solvents such as thinner, acetone or benzene for cleaning; they can remove paint and marks or deform the equipment.

12.9.2 Connectors and earth connection

Periodically check the connectors for proper seating and the earth connection for rust. Remove rust to maintain a good ground system.

12.9.3 Floppy disk drive

Foreign material on the floppy disk drive head can scratch the magnetic material in the floppy, resulting in loss of data. Clean the floppy disk drive head regularly with a floppy disk drive cleaning disk to prevent erasure of information stored on disks.

12.9.4 Diagnostics

General diagnostics

1. Press the function key [F6] to display the System menu.

System	
Setup	Lock
	Change Default
Slave Delay	8 msec (0- 50 msec)
TX/RX MSG Save	<u>OFF</u> O N
Edit Before sending	<u>OFF</u> O N
Time System	OFF <u>UTC</u> SMT JST
Time & Date	2002/10/16 10:00:00
Display Mode*	<u>Normal</u> Reverse
Self Test	

* = Window Color shown on IB-583.

System menu

2. Choose Change from Setup.
3. Choose Self Test (at the bottom of the screen).
4. Press the [Enter] key. The results of the self test are displayed a short time later.

Selftest		
Terminal Unit Test	: ver. X.XX	:OK
Main Unit Test	: ver. X.XX	:OK
Modem Unit Test	: ver. X.XX	:OK
Radio Unit Test	: ID FS1570*1	:OK
DSC Unit Test	: ID FS1570*1	:OK
Printer Unit Test*2:		:OK

← IB-58X

← MAIN Board

← NBDP Modem

X.XX = Version No.

*1: Or FS2570

*2: "NG" and "Printer not ready" when printer is off or is abnormal.

Self test results

The test results are shown as OK or NG (No Good). For any NG, try the self test again. If it appears again, call for service. When the test is completed, the message "Selftest Completed. Press any key to escape." appears.

Tone test

1. Choose Self Test from the System Menu as shown in paragraph 12.8.4.
2. While pressing and holding down the [Shift] key, press the [↓] key to show the Tone Test menu.

```

      Tone Test
-----
1: Tone Test 1 (All Char)
2: Tone Test 2 (Fox)
3: Tone Test 3 (Beta)
-----
4: Tone Test 4 (Mark)
5: Tone Test 5 (Space)
6: Tone Test 6 (BY)
    
```

Tone test menu

3. Choose a test and press the [Enter] key. You may stop a tone test at anytime by pressing the [Enter] key.

Tone test 1 (All characters)

This test checks for proper transmission of all figures, letters and codes. To conduct the test, call a station in the ARQ or FEC mode. Execute the test, confirming that all characters are transmitted correctly. "Now testing Tone Test 1" appears during the testing. Since the test is conducted continuously, you may press the [Esc] key twice followed by the [F10] key to stop the test and return to the tone test menu.

```

1:File 2:Edit 3:Operate 4:Window 5:Station 6:System 7:WRU 8:HR 9:Over 10:Break
-----
Station Name      :                               System
Frequency (T/R)  :                               Setup      Lock  Change  Default
Comm Status      :   Connect Sen
    
```

```

Now Testing Tone Test 1 (All Char).
    
```

ABCDEFGHIJKLMNOPQRSTUVWXYZ1234567890-?:().,'=/+abcdefghijklmnopqrstuv
wxyz

ABCDEFGHIJKLMNOPQRSTUVWXYZ1234567890-?:().,'=/+abcdefghijklmnopqrstuv
wxyz

ABCDEFGHIJKLMNOPQRSTUVWXYZ

Tone test

Tone test 2 (Fox)

This test (continuously) checks for proper transmission of the test message THE QUICK BROWN FOX JUMPS OVER THE LAZY DOG 0123456789. To conduct the test, call a station by using the ARQ or FEC mode.

Tone test 3 (Beta)

You may check for proper transmission of the idle signal β . Call up a station using the ARQ mode.

Tone test 4 (Mark)

This test outputs the mark signal through the LINE OUT terminal, where a frequency counter may be connected, to confirm its frequency (1615 Hz).

Tone test 5 (Space)

Tone test 5 verifies the space signal frequency (1785 Hz).

Tone test 6 (BY)

This test verifies the frequency of the space B (1785 Hz) and the mark Y (1615 Hz), using a spectrum analyzer.

APPENDIX

Menu Tree

DSC/watch receiver

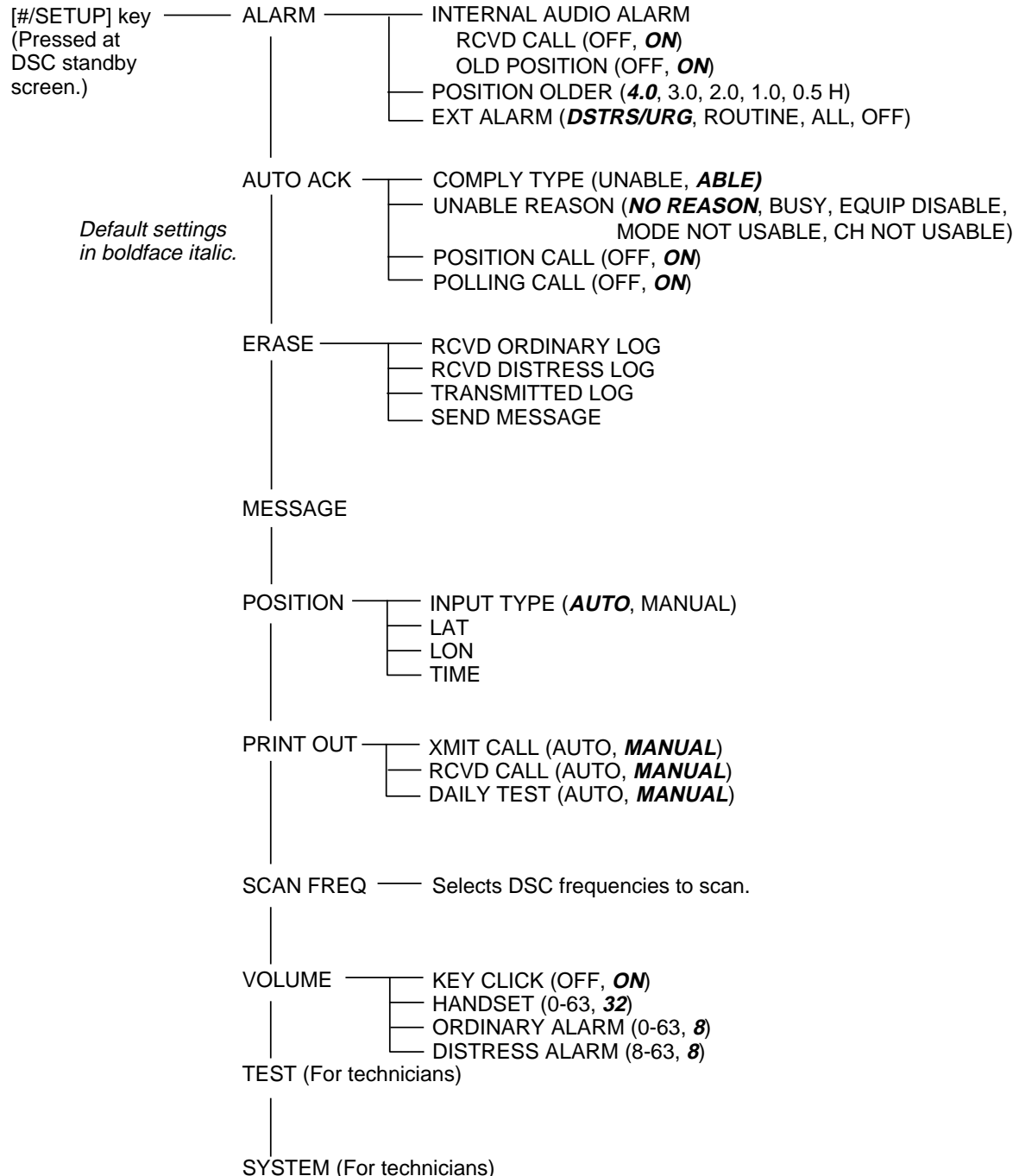

[LOG/TUNE] key — RECEIVED ORDINARY
RECEIVED DISTRESS
TRANSMITTED

Radiotelephone

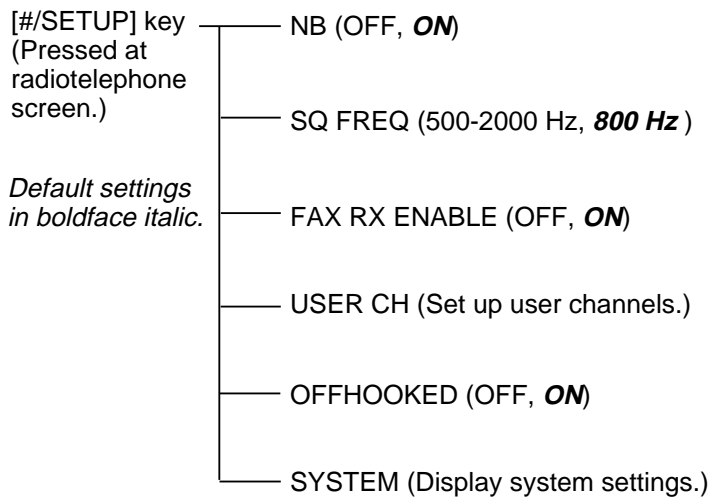

NBDP terminal unit (telex)

Default settings in boldface italic.

F1: File

- 1: New
- 2: Open
- 3: Close
- 4: Delete
- 5: Rename
- 6: Real Time Printing
- 7: File to Print
- 8: Cancel Printing
- 9: Clear Buffer
- 0: Floppy Disk Format

F2: Edit

- 1: Undo
- 2: Cut
- 3: Copy
- 4: Paste
- 5: Select All
- 6: Search
- 7: Replace
- 8: Goto Top
- 9: Goto Bottom
- 0: Goto Line
- A: Change Text

F3: Operate

- 1: Call Station
- 2: Macro Operation
- 3: File to Send
- 4: Cancel Sending
- 5: Scan (Start/Stop)
- 6: Manual Reception
- 7: Timer Operation
- 8: Manual Calling
- 9: Set Frequency

F4: Window

- 1: Calendar
- 2: Distress Frequency Table

F5: Station

- 1: Station Entry
- 2: Timer Operation Entry
- 3: Scan Entry
- 4: User Channel Entry
- 5: Answerback Code Entry
- 6: Group ID Entry (4/5 digit)
- 7: Group ID Entry (9 digit)
- 8: Select ID Entry (4/5 digit)
- 9: Select ID Entry (9 digit)

F6: System

- Setup (**Lock**, Change, Default)
- Slave Delay (0-50 msec, **8**)
- TX/RX MSG Save (**OFF**, ON)
- Edit Before Sending (**OFF**, ON)
- Time System (OFF, **UTC**, SMT, JST)
- Time & Date
- Display Mode (IB-581) (**Normal**, Reverse)
 - Window Color — Window — Window — BASE WINDOW, BACK SCROLL, EDIT 1-3, FUNCTION, SUB MENU 1-3, MESSAGE.Function, SUB Menu 1, SUB Menu 2, SUB Menu 3, SUB Menu 4, Message, Base Window
 - Change Color — Fore Color — L-WHITE, YELLOW,
 - (IB-583) Setup — Back Color — L-MAGENTA, L-RED, L-CYAN, L-GREEN, L-BLUE, GRAY, WHITE, BROWN, MAGENTA, RED, CYAN, GREEN, BLUE, BLACK
- Default Color (**Yes**, No)
- Self Test

F7: WRU (Who are you?)

F8: HR (Here is)

F9: Over

F10: Break

Frequency Tables

DSC frequency table

TX (kHz)	RX (kHz)	Remarks	File Name
2187.5	2187.5	Distress and Safety Frequencies	
4207.5	4207.5		
6312.0	6312.0		
8414.5	8414.5		
12577.0	12577.0		
16804.5	16804.5		
458.5	455.5	International Frequencies	INTL-0.4M
2189.5(2177.0*)	2177.0		INTL-2M
4208.0	4219.5		INTL-4M
6312.5	6331.0		INTL-6M
8415.0	8436.5		INTL-8M
12577.5	12657.0		INTL-12M
16805.0	16903.0		INTL-16M
18898.5	19703.5		INTL-18M
22374.5	22444.0		INTL-22M
25208.5	26121.0		INTL-25M
4208.5	4220.0	Local-1 Frequencies	LOCAL1-4M
6313.0	6331.5		LOCAL1-6M
8415.5	8437.0		LOCAL1-8M
12578.0	12657.5		LOCAL1-12M
16805.5	16903.5		LOCAL1-16M
18899.0	19704.0		LOCAL1-18M
22375.0	22444.5		LOCAL1-22M
25209.0	26121.5		LOCAL1-25M
4209.0	4220.5	Local-2 Frequencies	LOCAL2-4M
6313.5	6332.0		LOCAL2-6M
8416.0	8437.5		LOCAL2-8M
12578.5	12658.0		LOCAL2-12M
16806.0	16904.0		LOCAL2-16M
18899.5	19704.5		LOCAL2-18M
22375.5	22445.0		LOCAL2-22M
25209.5	26122.0		LOCAL2-25M

* = Ship-to-ship

MF band working carrier frequencies (ref. US CFR 47 Part 80.371)

Region	Ship Transmit (kHz)	Ship Receive (kHz)	Region	Ship Transmit (kHz)	Ship Receive (kHz)
East Coast	2031.5	2490.0	Gulf Coast	2009.0	2466.0
	2118.0	2514.0		2134.0	2530.0
	2126.0	2522.0		2142.0	2538.0
	2142.0	2538.0		2158.0 ¹	2550.0
	2166.0	2558.0		2166.0	2558.0
	2198.0	2590.0		2206.0	2598.0
	2366.0	2450.0		2366.0	2450.0
	2382.0	2482.0		2382.0	2482.0
	2390.0	2566.0		2430.0	2572.0
	2400.0	2400.0		2458.0	2506.0
	2406.0	2506.0			
West Coast	2003.0	2450.0	Great Lakes ²	2118.0	2514.0
	2009.0	2442.0		2158.0	2550.0
	2009.0	2566.0		2206.0	2582.0
	2031.5	2566.0	Alaska	2131.0	2309.0
	2126.0	2522.0		2134.0	2312.0
	2206.0	2598.0		2240.0	2400.0
	2382.0	2466.0	Hawaii	2134.0	2530.0
	2430.0	2482.0	Caribbean	2009.0	2506.0
				2086.0 ³	2585.0
				2134.0	2530.0
		Guam	2009.0	2506.0	

Above frequencies are not programmed. Contact a FURUNO representative.

1 = Unlimited use December 15 to April 1

2 = 2206 kHz for distress only

3 = Limited to pep of 150 W.

MF band SSB working carrier frequencies

CH NO	Ship Receive (kHz)	Ship Transmit (kHz)
241	1635	2060
242	1638	2063
243	1641	2066
244	1644	2069
245	1647	2072
246	1650	2075
247	1653	2078
248	1656	2081
249	1659	2084
250	1662	2087
251	1665	2090
252	1668	2093
253	1671	2096
254	1674	2099
255	1677	2102
256	1680	2105
257	1683	2108
258	1686	2111
259	1689	2114
260	1692	2117
261	1695	2120
262	1698	2123
263	1701	2126
264	1704	2129
265	1707	2132
266	1710	2135
267	1713	2138
268	1716	2060
269	1719	2063
270	1722	2066

CH NO	Ship Receive (kHz)	Ship Transmit (kHz)
271	1725	2069
272	1728	2072
273	1731	2075
274	1734	2078
275	1737	2081
276	1740	2084
277	1743	2087
278	1746	2090
279	1749	2093
280	1752	2096
281	1755	2099
282	1758	2102
283	1761	2105
284	1764	2108
285	1767	2111
286	1770	2114
287	1773	2117
288	1776	2120
289	1779	2123
290	1782	2126
291	1785	2129
292	1788	2132
293	1791	2135
294	1794	2138
295	1797	2060

4/6 MHz ITU SSB carrier frequencies (ITU RR Appendix 16)

4 MHz SSB (J3E)		
ITU CH NO	Ship RX	Ship TX
401	4357	4065
402	4360	4068
403	4363	4071
404	4366	4074
405	4369	4077
406	4372	4080
407	4375	4083
408	4378	4086
409	4381	4089
410	4384	4092
411	4387	4095
412	4390	4098
413	4393	4101
414	4396	4104
415	4399	4107
416	4402	4110
417	4405	4113
418	4408	4116
419	4411	4119
420	4414	4122
421	4417	4125
422	4420	4128
423	4423	4131
424	4426	4134
425	4429	4137
426	4432	4140
427	4435	4143
428	4351	4351
429	4354	4354
430	4146	4146
431	4149	4149
432 (01)	4000	4000
433 (02)	4003	4003
434 (03)	4006	4006
435 (04)	4009	4009
436 (05)	4012	4012
437 (06)	4015	4015
438 (07)	4018	4018
439 (08)	4021	4021
440 (09)	4024	4024
441 (10)	4027	4027
442 (11)	4030	4030
443 (12)	4033	4033
444 (13)	4036	4036
445 (14)	4039	4039
446 (15)	4042	4042
447 (16)	4045	4045
448 (17)	4048	4048
449 (18)	4051	4051
450 (19)	4054	4054
451 (20)	4057	4057
452 (21)	4060	4060

6 MHz SSB (J3E)		
ITU CH NO	Ship RX	Ship TX
601	6501	6200
602	6504	6203
603	6507	6206
604	6510	6209
605	6513	6212
606	6516	6215
607	6519	6218
608	6522	6221
609	6224	6224
610	6227	6227
611	6230	6230

These frequencies are factory programmed.

CH NOs in () are ITU NOs (RR Section C-1).

8 MHz ITU SSB carrier frequencies (ITU RR Appendix 16)

8 MHz SSB (J3E) - Duplex			8 MHz SSB (J3E) - Simplex		
ITU CH NO	Ship RX	Ship TX	(ITU CH NO)	Ship RX	Ship TX
801	8719	8195	840 (01)	8101	8101
802	8722	8198	841 (02)	8104	8104
803	8725	8201	842 (03)	8107	8107
804	8728	8204	843 (04)	8110	8110
805	8731	8207	844 (05)	8113	8113
806	8734	8210	845 (06)	8116	8116
807	8737	8213	846 (07)	8119	8119
808	8740	8216	847 (08)	8122	8122
809	8743	8219	848 (09)	8125	8125
810	8746	8222	849 (10)	8128	8128
811	8749	8225	850 (11)	8131	8131
812	8752	8228	851 (12)	8134	8134
813	8755	8231	852 (13)	8137	8137
814	8758	8234	853 (14)	8140	8140
815	8761	8237	854 (15)	8143	8143
816	8764	8240	855 (16)	8146	8146
817	8767	8243	856 (17)	8149	8149
818	8770	8246	857 (18)	8152	8152
819	8773	8249	858 (19)	8155	8155
820	8776	8252	859 (20)	8158	8158
821	8779	8255	860 (21)	8161	8161
822	8782	8258	861 (22)	8164	8164
823	8785	8261	862 (23)	8167	8167
824	8788	8264	863 (24)	8170	8170
825	8791	8267	864 (25)	8173	8173
826	8794	8270	865 (26)	8176	8176
827	8797	8273	866 (27)	8179	8179
828	8800	8276	867 (28)	8182	8182
829	8803	8279	868 (29)	8185	8185
830	8806	8282	869 (30)	8188	8188
831	8809	8285	870 (31)	8191	8191
832	8812	8288	CH NOs in () are ITU NOs (RR Section C-1).		
833	8291	8291			
834	8707	8707			
835	8710	8710			
836	8713	8713			
837	8716	8716			
838	8294	8294			
839	8297	8297			

12/16 ITU SSB carrier frequencies (ITU RR Appendix 16)

12 MHz SSB (J3E)			16 MHz SSB (J3E)			16 MHz SSB (J3E)		
CH NO.	SHIP RX	SHIP TX	CH NO.	SHIP RX	SHIP TX	CH NO.	SHIP RX	SHIP TX
1201	13077	12230	1601	17242	16360	1651	17392	16510
1202	13080	12233	1602	17245	16363	1652	17395	16513
1203	13083	12236	1603	17248	16366	1653	17398	16516
1204	13086	12239	1604	17251	16369	1654	17401	16519
1205	13089	12242	1605	17254	16372	1655	17404	16522
1206	13092	12245	1606	17257	16375	1656	17407	16525
1207	13095	12248	1607	17260	16378	1657	16528	16528
1208	13098	12251	1608	17263	16381	1658	16531	16531
1209	13101	12254	1609	17266	16384	1659	16534	16534
1210	13104	12257	1610	17269	16387	1660	16537	16537
1211	13107	12260	1611	17272	16390	1661	16540	16540
1212	13110	12263	1612	17275	16393	1662	16543	16543
1213	13113	12266	1613	17278	16396	1663	16546	16546
1214	13116	12269	1614	17281	16399			
1215	13119	12272	1615	17284	16402			
1216	13122	12275	1616	17287	16405			
1217	13125	12278	1617	17290	16408			
1218	13128	12281	1618	17293	16411			
1219	13131	12284	1619	17296	16414			
1220	13134	12287	1620	17299	16417			
1221	13137	12290	1621	17302	16420			
1222	13140	12293	1622	17305	16423			
1223	13143	12296	1623	17308	16426			
1224	13146	12299	1624	17311	16429			
1225	13149	12302	1625	17314	16432			
1226	13152	12305	1626	17317	16435			
1227	13155	12308	1627	17320	16438			
1228	13158	12311	1628	17323	16441			
1229	13161	12314	1629	17326	16444			
1230	13164	12317	1630	17329	16447			
1231	13167	12320	1631	17332	16450			
1232	13170	12323	1632	17335	16453			
1233	13173	12326	1633	17338	16456			
1234	13176	12329	1634	17341	16459			
1235	13179	12332	1635	17344	16462			
1236	13182	12335	1636	17347	16465			
1237	13185	12338	1637	17350	16468			
1238	13188	12341	1638	17353	16471			
1239	13191	12344	1639	17356	16474			
1240	13194	12347	1640	17359	16477			
1241	13197	12350	1641	17362	16480			
1242	12353	12353	1642	17365	16483			
1243	12356	12356	1643	17368	16486			
1244	12359	12359	1644	17371	16489			
1245	12362	12362	1645	17374	16492			
1246	12365	12365	1646	17377	16495			
			1647	17380	16498			
			1648	17383	16501			
			1649	17386	16504			
			1650	17389	16507			

Above is factory programmed.

18/19, 22, 25/26 ITU SSB carrier frequencies (ITU RR Appendix 16)

18/19 MHz SSB (J3E)			22 MHz SSB (J3E)			22 MHz SSB (J3E)		
CH NO.	SHIP RX	SHIP TX	CH NO.	SHIP RX	SHIP TX	CH NO.	SHIP RX	SHIP TX
1801	19755	18780	2201	22696	22000	2251	22846	22150
1802	19758	18783	2202	22699	22003	2252	22849	22153
1803	19761	18786	2203	22702	22006	2253	22852	22156
1804	19764	18789	2204	22705	22009	2254	22159	22159
1805	19767	18792	2205	22708	22012	2255	22162	22162
1806	19770	18795	2206	22711	22015	2256	22165	22165
1807	19773	18798	2207	22714	22018	2257	22168	22168
1808	19776	18801	2208	22717	22021	2258	22171	22171
1809	19779	18804	2209	22720	22024	2259	22174	22174
1810	19782	18807	2210	22723	22027	2260	22177	22177
1811	19785	18810	2211	22726	22030			
1812	19788	18813	2212	22729	22033			
1813	19791	18816	2213	22732	22036			
1814	19794	18819	2214	22735	22039			
1815	19797	18822	2215	22738	22042			
1816	18825	18825	2216	22741	22045			
1817	18828	18828	2217	22744	22048			
1818	18831	18831	2218	22747	22051			
1819	18834	18834	2219	22750	22054			
1820	18837	18837	2220	22753	22057			
1821	18840	18840	2221	22756	22060			
1822	18843	18843	2222	22759	22063			
			2223	22762	22066			
			2224	22765	22069			
			2225	22768	22072			
			2226	22771	22075			
			2227	22774	22078			
			2228	22777	22081			
			2229	22780	22084			
			2230	22783	22087			
			2231	22786	22090			
			2232	22789	22093			
			2233	22792	22096			
			2234	22795	22099			
			2235	22798	22102			
			2236	22801	22105			
			2237	22804	22108			
			2238	22807	22111			
			2239	22810	22114			
			2240	22813	22117			
			2241	22816	22120			
			2242	22819	22123			
			2243	22822	22126			
			2244	22825	22129			
			2245	22828	22132			
			2246	22831	22135			
			2247	22834	22138			
			2248	22837	22141			
			2249	22840	22144			
			2250	22843	22147			

25/26 MHz SSB (J3E)		
CH NO	Ship RX	Ship TX
2501	26145	25070
2502	26148	25073
2503	26151	25076
2504	26154	25079
2505	26157	25082
2506	26160	25085
2507	26163	25088
2508	26166	25091
2509	26169	25094
2510	26172	25097
2511	25100	25100
2512	25103	25103
2513	25106	25106
2514	25109	25109
2515	25112	25112
2516	25115	25115
2517	25118	25118

MF band telex frequency table

CH NO.	Ship Transmit (NBDP, DSC)	Ship Receive (NBDP, DSC)	
201	2142.0	1607.0	NBDP/DSC
202	2142.5	1607.5	
203	2143.0	1608.0	
204	2143.5	1608.5	
205	2144.0	1609.0	
206	2144.5	1609.5	
207	2145.0	1610.0	
208	2145.5	1610.5	
209	2146.0	1611.0	
210	2146.5	1611.5	
211	2147.0	1612.0	
212	2147.5	1612.5	
213	2148.0	1613.0	
214	2148.5	1613.5	
215	2149.0	1614.0	
216	2149.5	1614.5	
217	2150.0	1615.0	
218	2150.5	1615.5	
219	2151.0	1616.0	
220	2151.5	1616.5	
221	2152.0	1617.0	
222	2152.5	1617.5	
223	2153.0	1618.0	
224	2153.5	1618.5	
225	2154.0	1619.0	
226	2154.5	1619.5	
227	2155.0	1620.0	
228	2155.5	1620.5	
229	2156.0	1621.0	
230	2156.5	1621.5	
231	2157.0	1622.0	
232	2157.5	1622.5	
233	2158.0	1623.0	
234	2158.5	1623.5	
235	2159.0	1624.0	
236	2159.5	1624.5	

ITU Telex frequency table (4/4)

ITU TELEX FREQUENCY TABLE (4/4)

FURUNO

4 MHz BAND		6 MHz BAND		8 MHz BAND		12 MHz BAND		16 MHz BAND		18/19 MHz BAND		22 MHz BAND		25/26 MHz BAND			
No.	Tx	Rx	No.	Tx	Rx	No.	Tx	Rx	No.	Tx	Rx	No.	Tx	Rx	No.	Tx	Rx
								16196	16786.0	16786.0							
								16197	16786.5	16786.5							
								16198	16787.0	16787.0							
								16199	16787.5	16787.5							
								16200	16788.0	16788.0							
								16201	16788.5	16788.5							
								16202	16789.0	16789.0							
								16203	16789.5	16789.5							
								16204	16790.0	16790.0							
								16205	16790.5	16790.5							
								16206	16791.0	16791.0							
								16207	16791.5	16791.5							
								16208	16792.0	16792.0							
								16209	16792.5	16792.5							
								16210	16793.0	16793.0							
								16211	16793.5	16793.5							
								16212	16794.0	16794.0							
								16213	16794.5	16794.5							
								16214	16795.0	16795.0							
								16215	16795.5	16795.5							
								16216	16796.0	16796.0							
								16217	16796.5	16796.5							
								16218	16797.0	16797.0							
								16219	16797.5	16797.5							
								16220	16798.0	16798.0							
								16221	16798.5	16798.5							
								16222	16799.0	16799.0							
								16223	16799.5	16799.5							
								16224	16800.0	16800.0							
								16225	16800.5	16800.5							
								16226	16801.0	16801.0							
								16227	16801.5	16801.5							
								16228	16802.0	16802.0							
								16229	16802.5	16802.5							
								16230	16803.0	16803.0							
								16231	16803.5	16803.5							
								16232	16804.0	16804.0							
								16233	16804.5	16804.5							
								16234	16805.0	16805.0							
								16235	16805.5	16805.5							
								16236	16806.0	16806.0							

Telex Abbreviations

Abbreviation	Meaning
ADV	Advise
ACK	Acknowledge
AGN	Again
BI (GS)	Good bye
BK	I cut off.
CFM	Confirm
COL	Collation
CRV	How do you receive?
DER	Out of order
DWN	Down
EEE	Error
FM	From
GA	Go ahead.
MNS	Minutes
MOM	Wait (Waiting)
MUTI	Mutilated
NA	Correspondence to this subscriber is not admitted.
NC	No circuits
NCH	Subscriber's number has been changed.
NP	The called party is not or no longer is a subscriber.
NR	Indicate your call number.
OCC	Subscriber is engaged.
OK	Agreed.
P (or 0)	Stop your transmission.
PLS (PSE)	Please
PPR	Paper
R (RCD)	Received
RAP	I will call you again.
RD	Read
RE	Referrring to
RPT	Repeat
SRY	Sorry
SVP	Please
TAX	What is the charge?
TEST MSG	Please send a test message?
THRU	You are in communication with telex position
TKS (TNX)	Thanks
TLX	Telex

Digital Interface (IEC 61162-1)

1. I/O Sentences

Input sentences (IEC 61162-1)

RMA, RMC, GLL, GGA, ZDA

Input sentence description

GGA - Global positioning system(GPS) fix data

\$--GGA,hhmmss.ss,lll.lll,a,yyyyy.yyy,a,x,xx,x.x,x.x,M,x.x,M,x.x,xxxx*hh<CR><LF>

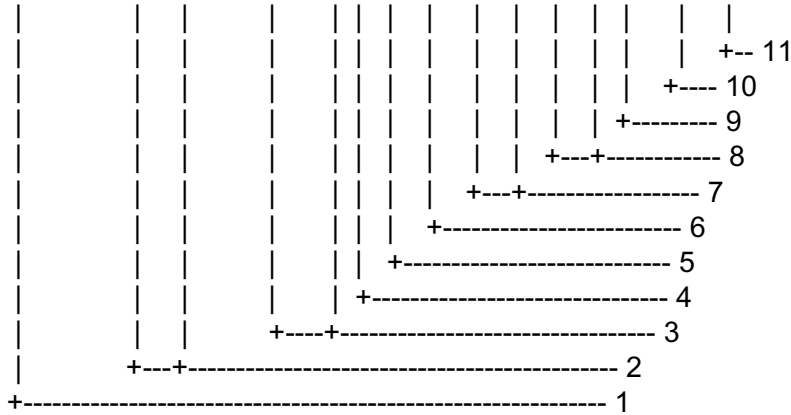

1. UTC of position
2. Latitude, N/S
3. Longitude, E/W
4. GPS quality indicator
5. Number of satellite in use,00-12, may be different from the number in view
6. Horizontal dilution of precision
7. Antenna altitude above/below mean sealevel, m
8. Geoidal separation, m
9. Age of differential GPS data
10. Differential reference station ID, 0000-1023
11. Checksum

GLL - Geographic position - latitude/longitude

```
$--GLL,III.III,a,yyyyy.yyy,a,hhmmss.ss,A,a*hh<CR><LF>
```

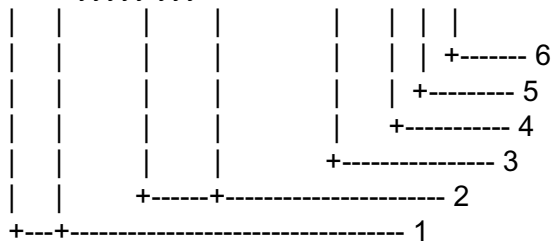

1. Latitude, N/S
2. Longitude, E/W
3. UTC of position
4. Status: A=data valid, V=data invalid
5. Mode indicator(see note)
6. Checksum

NOTE Positioning system Mode indicator:

- A = Autonomous
- D = Differential
- E = Estimated (dead reckoning)
- M = Manual input
- S = Simulator
- N = Data not valid

The Mode indicator field supplements the Status field. The Status field shall be set to V=invalid for all values of Operating Mode except for A=Autonomous and D=Differential. The positioning system Mode indicator and Status field shall not be null fields.

ZDA - Time and date

```
$--ZDA,hhmmss.ss,xx,xx,xxxx,xx,xx*hh<CR><LF>
```

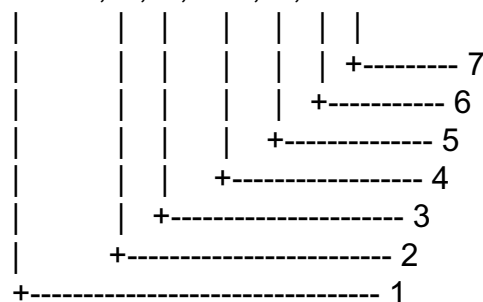

1. UTC
2. Day, 01 to 31(UTC)
3. Month, 01 to 12(UTC)
4. Year(UTC)
5. Local zone hours, 00h to +-13h
6. Local zone minutes, 00 to +59
as local hours
7. Checksum

RMA - Recommended minimum specific LORAN-C data

\$--RMA,A,III.III,a,yyyyy.yy,a,x.x,x.x,x.x,x.x,x.x,a,a*hh<CR><LF>

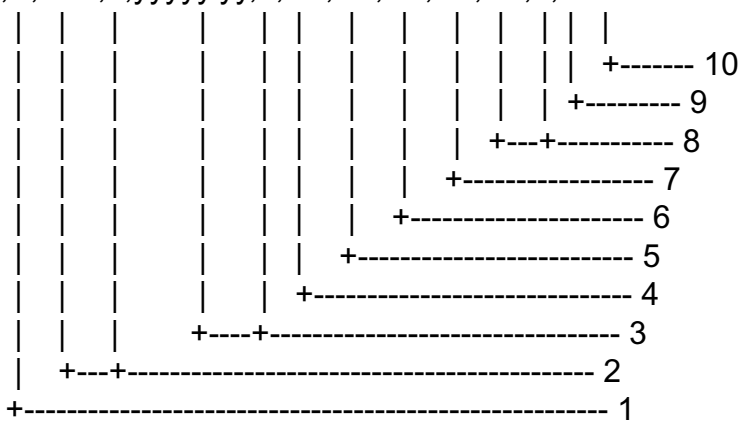

1. Status: A=data valid, V=blink, cycle or SNR warning
2. Latitude, degrees N/S
3. Longitude, degrees E/W
4. Time difference A, microseconds
5. Time difference B, microseconds
6. Speed over ground, knots
7. Course over ground, degrees true
8. Magnetic variation(see note 1),degree E/W
9. Mode indicator(see note 2)
10. Checksum

NOTE 1 - Easterly variation(E) subtracts from true course
 Westerly variation(W) adds to true course

NOTE 2 Positioning system Mode indicator:

- A = Autonomous
- D = Differential
- E = Estimated (dead reckoning)
- M = Manual input
- S = Simulator
- N = Data not valid

The Mode indicator field supplements the Status field. The Status field shall be set to V=invalid for all values of Operating Mode except for A=Autonomous and D=Differential. The positioning system Mode indicator and Status field shall not be null fields.

RMC - Recommended minimum specific GPS/TRANSIT data

```
$--RMC,hhmmss.ss,A,lll.lll,a,yyyyy.yyy,a,x.x,x.x,xxxxxx,x.x,a,a*hh<CR><LF>
```

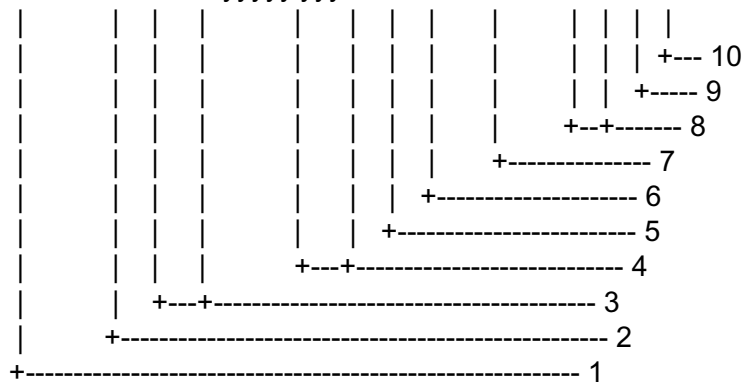

1. UTC of position fix
2. Status: A=data valid, V=navigation receiver warning
3. Latitude, N/S
4. Longitude, E/W
5. Speed over ground, knots
6. Course over ground, degrees true
7. Date: dd/mm/yy
8. Magnetic variation, degrees E/W
9. Mode indicator(see note)
10. Checksum

NOTE Positioning system Mode indicator:

- A = Autonomous
- D = Differential
- E = Estimated (dead reckoning)
- M = Manual input
- S = Simulator
- N = Data not valid

The Mode indicator field supplements the Status field. The Status field shall be set to V=invalid for all values of Operating Mode except for A=Autonomous and D=Differential. The positioning system Mode indicator and Status field shall not be null fields.

2. Schematic diagram

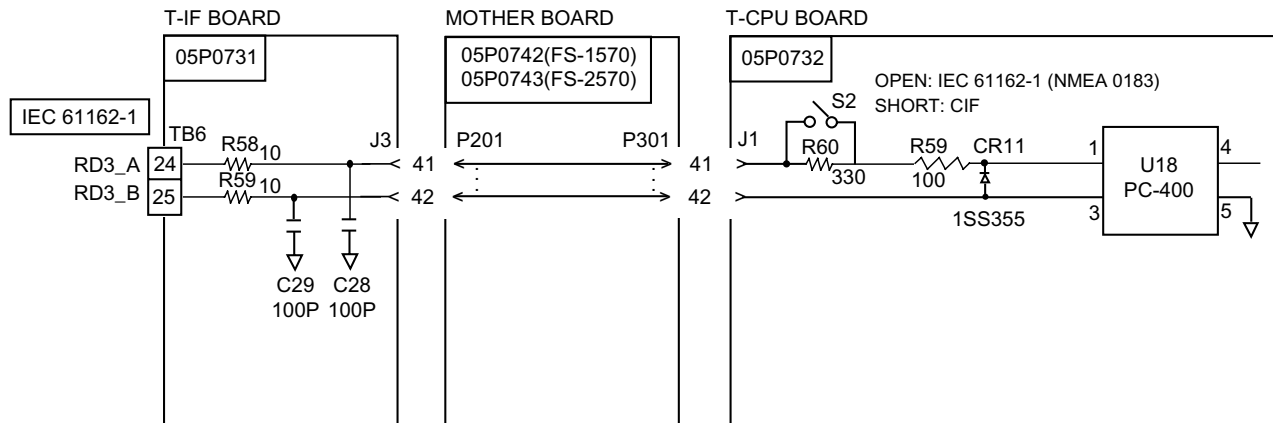

Load requirements as a listener

Isolation: Optocoupler

Input impedance: 450Ω

Max. voltage: ±15 V

Threshold: 4 mA

Parts List

This equipment contains complex modules in which fault diagnosis and repair down to component level are not practical (IMO A.694(17)/8.3.1). Only some discrete components are used. FURUNO Electric Co., Ltd. Believes identifying these components is of no value for shipboard maintenance; therefore, they are not listed in this manual. Major modules can be located on the parts location photos on pages AP-26 thru AP-28.

Control unit FS-1570/2570

FURUNO

Model	FS-1570/2570	
Unit	CONTROL UNIT	
Blk.No.		

ELECTRICAL PARTS LIST

Aug-02

SYMBOL	TYPE	CODE No.	REMARKS	SHIPPABLE ASSEMBLY
PRINTED CIRCUIT BOARD				
B2	05P0728, PANEL	005-951-870		X
B3	05P0729, C-CPU	005-951-880		X
B4	05P0730, C-IF	005-951-890		X

Transceiver unit FS-1570T

FURUNO

Model	FS-1570T	
Unit	TRANSCEIVER UNIT	
Bik.No.		

ELECTRICAL PARTS LIST

Aug-02

SYMBOL	TYPE	CODE No.	REMARKS	SHIPPABLE ASSEMBLY
PRINTED CIRCUIT BOARD				
B2	05P0731, T-IF	005-952-000		X
B3	05P0732, T-CPU	005-952-010		X
B4	05P0733, TX-RX	005-952-030		X
B5	05P0734, W/R	005-952-060		X
B6	05P0735, PA	005-952-140		X
B7	05P0736, TX-FIL	005-952-100		X
B8	05P0737, SW-REG	005-952-110		X
B9	05P0742, M-B	005-951-980		X
B10	05P0746, PRESEL	005-952-040		X
B11	05P0747, REF OSC	005-952-050		X
B13, 14	05P0751, DSP	005-952-020		X
B17	05P0744, RELAY	005-952-070		X

Transceiver unit FS-2570T

FURUNO

Model	FS-2570T	
Unit	TRANSCEIVER UNIT	
Blk.No.		

ELECTRICAL PARTS LIST

Aug-02

SYMBOL	TYPE	CODE No.	REMARKS	SHIPPABLE ASSEMBLY
PRINTED CIRCUIT BOARD				
B2	05P0731, T-IF	005-952-000		X
B3	05P0732, T-CPU	005-952-010		X
B4	05P0733, TX-RX	005-952-030		X
B5, B18	05P0734, W/R	005-952-060		X
B6, B17	05P0739, PA	005-952-130		X
B7	05P0736, TX-FIL	005-952-100		X
B8	05P0737, SW-REG	005-952-110		X
B9	05P0743, M-B	005-951-990		X
B10	05P0746, PRESEL	005-952-040		X
B11	05P0747, REF OSC	005-952-050		X
B12	05P0744, RELAY	005-952-070		X
B13, 14	05P0751, DSP	005-952-020		X
B15	05P0738, DRV	005-952-212		X
B16	05P0740, COMB	005-952-150		X

Parts Location

Transceiver unit FS-2570T

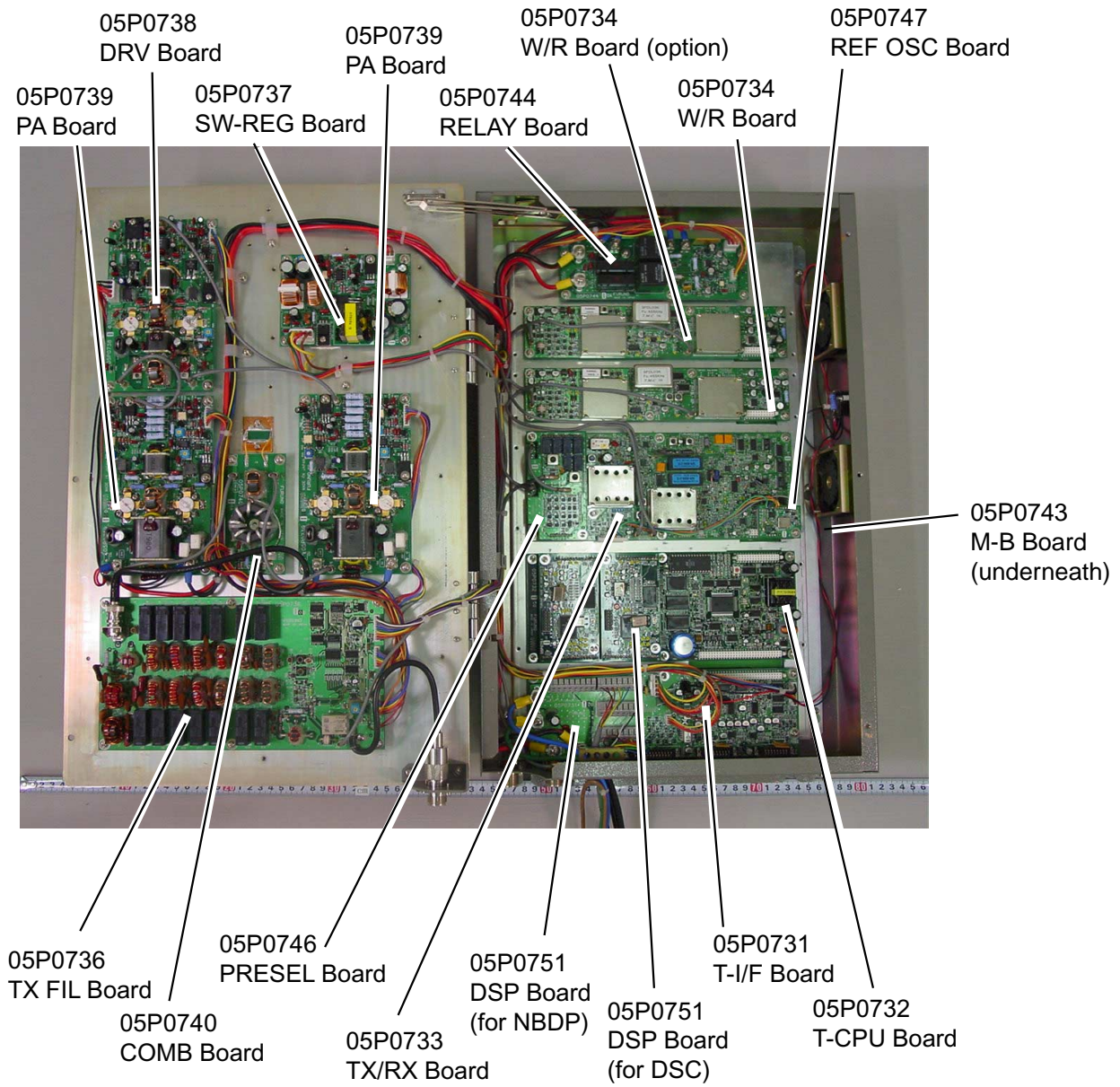

Transceiver unit FS-1570T

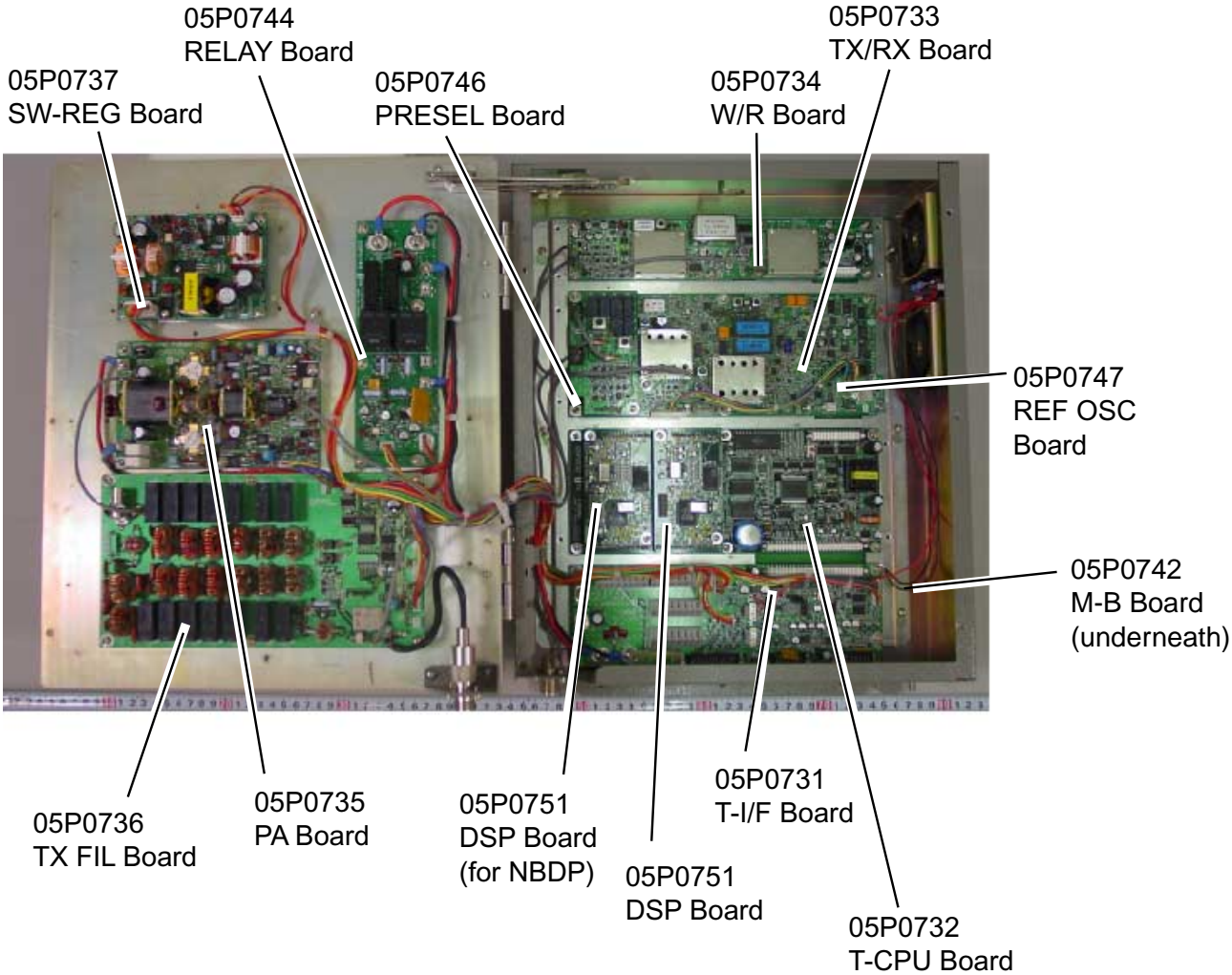

Control unit FS-2570C

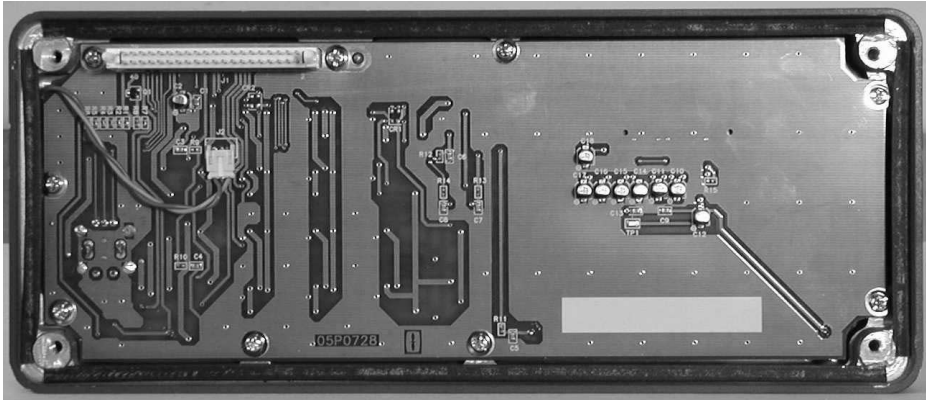

05P0728
PANEL Board

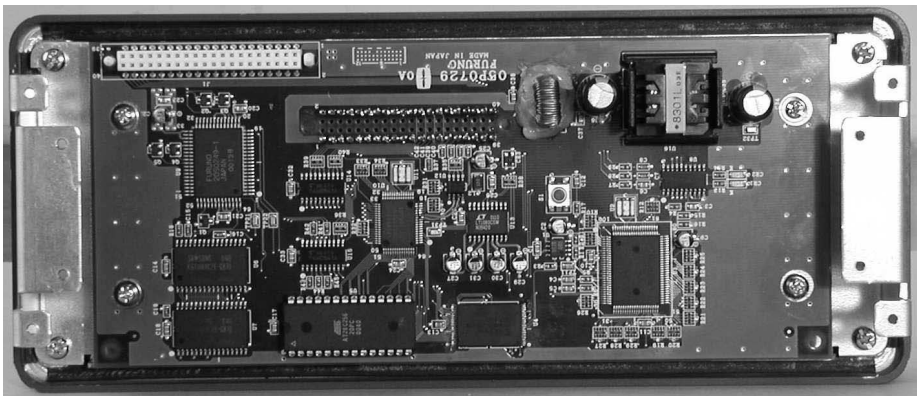

05P0729
CPU Board

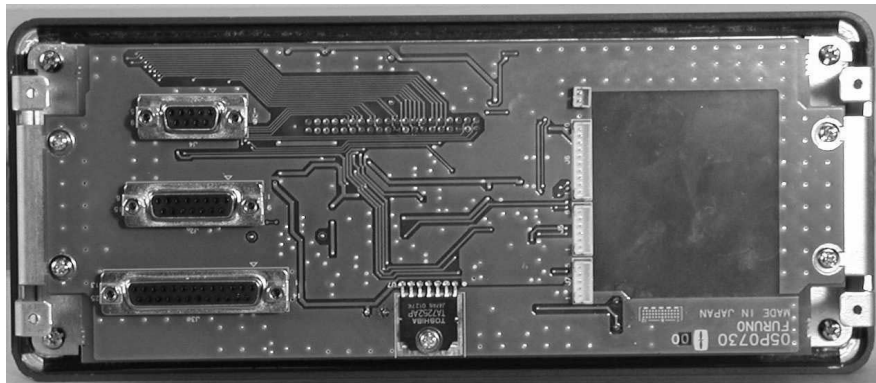

05P0730
C-I/F Board

INDEX

- 1**
 - 1/ RT/2182 key1-3
- 2**
 - 2/DSC key.....1-1
- 4**
 - 4/Intcom key2-8
- 5**
 - 5/ ACK/SQ key.....1-4
- 6**
 - 6/SCAN key 1-3, 1-4
- 7**
 - 7/🔊 key1-4
- 8**
 - 8/PRINT key7-3
- 9**
 - 9/📶 key.....1-2
- A**
 - Alarm menu7-1
 - All ships call
 - receiving5-3
 - sending5-1
 - Antenna current2-4
 - Auto ack menu.....7-2
- C**
 - Channel selection2-2
 - Contrast1-2
 - Control description.....1-1
- D**
 - Daily test12-1
 - Dimmer1-2
 - Distress alert
 - receiving on either VHF channel 70 or MF
 - channel 2187.54-7
 - receiving on HF band4-9
 - sending4-1
 - Distress relay
 - on behalf of other ship, to all ships.....4-16
 - on behalf of other ship, to coast station 4-13
 - receiving4-19
 - to coast station on HF band4-9
- DSC frequency table..... 4
- E**
 - Error messages..... 12-5
- F**
 - FILE/CURSOR key 6-9
 - Frequency selection..... 2-3
- G**
 - Geographical area call
 - receiving..... 5-22
 - sending..... 5-19
 - Group call
 - receiving..... 5-18
 - sending..... 5-15
- I**
 - IA2-4, 2-5
 - IC 2-5
 - Individual call
 - automatic acknowledge 5-10
 - manual acknowledge 5-12
 - sending..... 5-4
 - Intercom 2-8
- L**
 - Log file
 - description..... 5-45
 - opening 5-45
 - LOG/TUNE key 5-45
- M**
 - Medical transport call
 - receiving..... 5-27
 - sending..... 5-26
 - Menu tree 1
- N**
 - NBDP Terminal Unit
 - answerback code registration 9-1
 - ARQ mode 11-3
 - communications buffer..... 11-10
 - edit menu [F2] 8-6
 - FEC mode 11-5
 - file creating..... 10-1
 - file deleting 10-9
 - file editing 10-5

INDEX

- file menu [F1] 8-6
- file opening 10-8
- file renaming 10-9
- file saving 10-3
- file saving under new name 10-9
- general test 12-10
- ID code registration 9-2
- macrofiles 11-10
- manual calling 11-1
- menu overview 8-4
- operate menu [F3] 8-8
- printing 10-9
- receive mode 11-5
- scan channel group editing, deleting 9-8
- scan channel group registration 9-7
- scanning 11-9
- station editing, deleting 9-4
- station menu [F5] 8-10
- station registration 9-3
- system menu [F6] 8-11
- terminal unit 8-1
- timer operation 11-8
- timer program editing, deleting 9-6
- timer program registration 9-5
- tone test 12-11
- user channel editing, deleting 9-7
- user channel registration 9-6
- window menu [F4] 8-9
- Neutral craft call
 - receiving 5-25
 - sending 5-23
- P**
- Polling call
 - receiving 5-31
 - sending 5-28
- Position call
 - other ship requests your position 5-36
 - requesting other ship's position 5-34
- Position entry (manual) 1-5
- POWER switch 1-2
- Print out menu 7-3
- PSTN call
 - charge information 5-43
 - receiving 5-42
 - sending 5-38
- R**
- RF 2-5
- S**
- Scan freq menu 7-4
- Scan frequency setup 7-5
- Scanning 1-4
- Send message files
 - geographical area call 6-6
 - group call 6-4
 - individual call 6-1
 - printing 6-10
 - PSTN call 6-7
 - sending 6-9
 - test call 6-8
- T**
- Test call 12-7
- Time entry (manual) 1-5
- Transmitter power 2-5
- Troubleshooting 12-5
- Tuning 2-3
- U**
- USER CH menu 2-10
- User channels
 - deleting 2-12
 - registering 2-10
- V**
- VC 2-5
- Volume menu 7-6

FURUNO®

FURUNO ELECTRIC CO., LTD.9-52 Ashihara-Cho, Nishinomiya City, 662-8580, Hyogo, Japan
Tel: +81 798-65-2111 Fax: +81 798-65-4200

Pub NO. DOC-496

Declaration of conformity

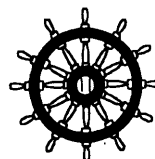

0560

We **FURUNO ELECTRIC CO., LTD.**

(Manufacturer)

9-52 Ashihara-Cho, Nishinomiya City, 662-8580, Hyogo, Japan

(Address)

hereby declare under our sole responsibility that the product

MF/HF SSB Radiotelephone model FS-1570 consisting of Control unit FS-2570C, Transceiver unit FS-1570T, Handset/Bracket HS-2001/HCS701K-B20, Antenna coupler AT-1560-15, Incoming call indicator IC-303-DSC, Telex distress alert button IC-302-DSC, NBDP-controller monochrome display IB-581, NBDP-controller color display IB-582/IB-583, Printer PP-510, Printer switch box IF-8500, Distress message controller DMC-5, 2.6 m active whip antenna for WKR FAX-5, External loudspeaker SEM-21Q and AC power supply PR-300/PR-850A

(Model names, type numbers)

to which this declaration relates conforms to the following standard(s) or normative document(s)

Standards

IMO Resolution MSC.36(63), A.806(19), A.694(17) and MSC.68(68) annex 3

IMO MSC Circular MSC/Circ.862

EN 60945: 1997-01 (IEC 60945 Ed.03: 1996-11), EN 61162-1: 2000-07 (IEC 61162-1 Ed.02: 2000-07)

EN 300 338 V1.2.1: 1999-04, EN 301 033 V1.1.1: 1998-08

ETS 300 067 Ed.01: 1990-11 + A1: 1993-10, ETS 300 373 Ed.01: 1995-08 + A1: 1997-08

ITU-R Recommendations M.1173, M.476-5, M.491-1, M.492-6, M.493-10, M541-8, M.625-3

(title and/or number and date of issue of the standard(s) or other normative document(s))

For assessment, see

- EC type-examination certificate N°: 02212010/AA/01 of 19 September 2002 issued by Telefication The Netherlands
- Test report 98752230, 98752232 and 98752234 of 17 June 2002 issued by Telefication, The Netherlands
- Test reports FLI 12-02-019 of 20 May 2002 and FLI 12-02-036 of 30 August 2002 issued by Furuno Labotech International Co., Ltd.

This declaration is issued according to the provisions of European Council Directive 96/98/EC on marine equipment as amended by Commission Directive 2001/53/EC.

On behalf of Furuno Electric Co., Ltd.

Hiroaki Komatsu
Manager;
International Rules and Regulations

Nishinomiya City, Japan
October 1, 2002

(Place and date of issue)

(name and signature or equivalent marking of authorized person)

FURUNO®

FURUNO ELECTRIC CO., LTD.9-52 Ashihara-Cho, Nishinomiya City, 662-8580, Hyogo, Japan
Tel: +81 798-65-2111 Fax: +81 798-65-4200

Pub NO. DOC-497

Declaration of conformity

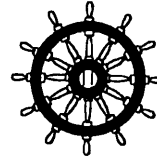

0560

We **FURUNO ELECTRIC CO., LTD.**

(Manufacturer)

9-52 Ashihara-Cho, Nishinomiya City, 662-8580, Hyogo, Japan

(Address)

hereby declare under our sole responsibility that the product

MF/HF SSB Radiotelephone model FS-2570 consisting of Control unit FS-2570C, Transceiver unit FS-2570T, Handset/Bracket HS-2001/HCS701K-B20, Antenna coupler AT-1560-25, Incoming call indicator IC-303-DSC, Telex distress alert button IC-302-DSC, NBDP-controller monochrome display IB-581, NBDP-controller color display IB-582/583, Printer PP-510, Printer switch box IF-8500, Distress message controller DMC-5, 2.6 m active whip antenna for WKR FAX-5, External loudspeaker SEM-21Q and AC power supply PR-PR-850A

(Model names, type numbers)

to which this declaration relates conforms to the following standard(s) or normative document(s)

Standards

IMO Resolution MSC.36(63), A.806(19), A.694(17) and MSC.68(68) annex 3

IMO MSC Circular MSC/Circ.862

EN 60945: 1997-01 (IEC 60945 Ed.03: 1996-11), EN 61162-1: 2000-07 (IEC 61162-1 Ed.02: 2000-07)

EN 300 338 V1.2.1: 1999-04, EN 301 033 V1.1.1: 1998-08

ETS 300 067 Ed.01: 1990-11 + A1: 1993-10, ETS 300 373 Ed.01: 1995-08 + A1: 1997-08

ITU-R Recommendations M.1173, M.476-5, M.491-1, M.492-6, M.493-10, M541-8, M.625-3

(title and/or number and date of issue of the standard(s) or other normative document(s))

For assessment, see

- EC type-examination certificate N°: 02212010/AA/01 of 19 September 2002 issued by Telefication The Netherlands
- Test report 98752231, 98752233 and 98752235 of 17 June 2002 issued by Telefication, The Netherlands
- Test reports FLI 12-02-019 of 20 May 2002 and FLI 12-02-036 of 30 August 2002 issued by Furuno Labotech International Co., Ltd.

This declaration is issued according to the provisions of European Council Directive 96/98/EC on marine equipment as amended by Commission Directive 2001/53/EC.

On behalf of Furuno Electric Co., Ltd.

Hiroaki Komatsu
Manager,
International Rules and Regulations

Nishinomiya City, Japan
October 1, 2002

(Place and date of issue)

(name and signature or equivalent marking of authorized person)