

SAILOR 500/250 FleetBroadband



Thrane & Thrane A/S

SAILOR[®] 500 FleetBroadband
SAILOR[®] 250 FleetBroadband

User manual

Document number: TT98-125645-D

Release date: April 25, 2008

Information in this document is subject to change without notice and does not represent a commitment on the part of Thrane & Thrane A/S. We recommend downloading the latest version of the manual from the Thrane & Thrane Extranet.

Copyright © 2008 Thrane & Thrane A/S. All rights reserved.

Trademark acknowledgements:

- **Thrane & Thrane** is a registered trademark of Thrane & Thrane A/S in the European Union and the United States.
- **SAILOR** is a registered trademark of Thrane & Thrane A/S in the European Union, the United States and other countries.
- **Windows** and **Outlook** are registered trademarks of Microsoft Corporation in the United States and other countries.
- **Inmarsat** is a registered trademark of International Maritime Satellite Organisation (IMSO) and is licensed by IMSO to Inmarsat Limited and Inmarsat Ventures plc.
- Inmarsat's product names are trademarks or registered trademarks of Inmarsat.
- Other product and company names mentioned in this manual may be trademarks or trade names of their respective owners.

Company addresses

www.thrane.com

Denmark

Company headquarters

Thrane & Thrane A/S
Lundtoftegårdsvej 93 D
DK-2800 Kgs. Lyngby
Denmark

Denmark

Thrane & Thrane Aalborg A/S
Porsvej 2
DK-9200 Aalborg SV
Denmark

USA

Thrane & Thrane, Inc.
509 Viking Drive, Suites K, L and M
Virginia Beach, VA 23452
USA

China

Thrane & Thrane Shanghai
Unit 602 - Building 4,
289 Bisheng Rd.
Zhangjiang High-tech Park,
Pudong
201204 Shanghai
P. R. China

Safety summary

The following general safety precautions must be observed during all phases of operation, service and repair of this equipment. Failure to comply with these precautions or with specific warnings elsewhere in this manual violates safety standards of design, manufacture and intended use of the equipment. Thrane & Thrane assumes no liability for the customer's failure to comply with these requirements.

Observe marked areas

Under extreme heat conditions do not touch areas of the terminal or antenna that are marked with this symbol, as it may result in injury.



Microwave radiation hazards

During transmission the antenna in this system radiates Microwave Power. This radiation may be hazardous to humans close to the antenna. During transmission, make sure that nobody gets closer than the recommended minimum safety distance.

On the **SAILOR 500 FleetBroadband**, the minimum safety distance to the antenna panel on the focal line is 1.3 m, based on a radiation level of 10 W/m². The radiation level is 100 W/m² at a distance of 0.4 m from the antenna panel. Refer to the drawing on the next page.



On the **SAILOR 250 FleetBroadband**, the minimum safety distance to the antenna panel on the focal line is 0.6 m, based on a radiation level of 10 W/m². The radiation level is 100 W/m² at a distance of 0.2 m from the antenna panel. Refer to the drawing on the next page.



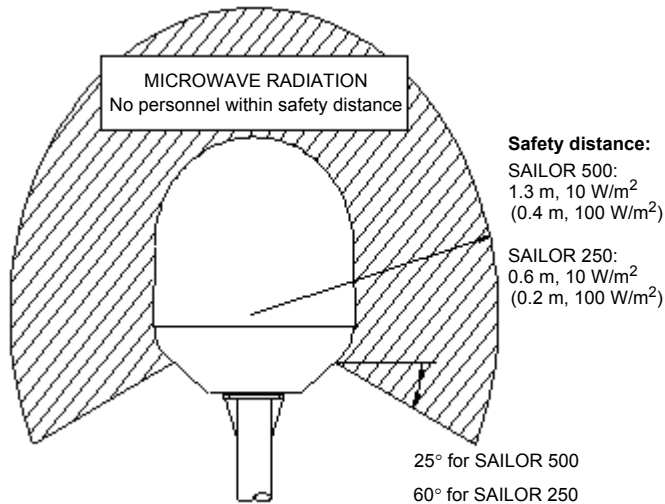

Distance to other equipment

Do not move the antenna closer to radars than the minimum safe distance specified in the installation manual - it may cause damage to the antenna. The equipment must be installed with the following minimum safe distances to magnetic steering compass:

- SAILOR FleetBroadband terminal: min. 0.3 m.
- SAILOR 500 FleetBroadband antenna: min. 1.0 m
- SAILOR 250 FleetBroadband antenna: min. 1.1 m

Service

User access to the interior of the terminal is prohibited. Only a technician authorized by Thrane & Thrane may perform service - failure to comply with this rule will void the warranty. Access to the interior of the antenna is allowed, but only for replacement of certain modules - as described in the Installation manual. General service may only be performed by a technician authorized by Thrane & Thrane.

Do not service or adjust alone

Do not attempt internal service or adjustments unless another person, capable of rendering first aid resuscitation, is present.

Grounding, cables and connections

To minimize shock hazard, the equipment chassis and cabinet must be connected to an electrical ground. Both terminal and antenna must be grounded to the vehicle. For further grounding information refer to the Installation manual.

Do not extend the cables beyond the lengths specified for the equipment. The cable between the terminal and antenna can be extended if it complies with the specified data concerning cable losses etc.

All cables for the SAILOR FleetBroadband system are shielded and should not be affected by magnetic fields. However, try to avoid running cables parallel to AC wiring as it might cause malfunction of the equipment.

Power supply

The voltage range is 10.5 - 32 V DC; 14 A - 5.5 A. It is recommended that the voltage is provided by the 24 V DC bus on the ship. Be aware of high start-up peak current: 20 A@24 V, 5 ms.

If a 24 V DC power bus is not available, an external 115/230 VAC to 24 V DC power supply can be used.

Do not operate in an explosive atmosphere

Do not operate the equipment in the presence of flammable gases or fumes. Operation of any electrical equipment in such an environment constitutes a definite safety hazard.

Keep away from live circuits

Operating personnel must not remove equipment covers. Component replacement and internal adjustment must be made by qualified maintenance personnel. Do not replace components with the power cable connected. Under certain conditions, dangerous voltages may exist even with the power cable removed. To avoid injuries, always disconnect power and discharge circuits before touching them.

Failure to comply with the rules above will void the warranty!

About the manual

Intended readers

This manual is a user manual for the SAILOR 500 FleetBroadband system and the SAILOR 250 FleetBroadband system. The readers of the manual include anyone who is using or intends to use one of these two systems. No specific skills are required to operate the SAILOR FleetBroadband system. However, it is important that you observe all safety requirements listed in the beginning of this manual, and operate the system according to the guidelines in this manual.

Manual overview

Note that this manual does not cover installation nor does it cover how to use the IP handset that comes with the system. For information on installation refer to the installation manual and for information on the IP handset refer to the user manual for the IP handset. Part numbers for both manuals are listed in the next section.

This manual has the following chapters:

- **Introduction** contains an overview of the BGAN services and a brief description of the system.
- **Getting started** explains how to insert SIM card and start up the unit. It also contains a short guide to making the first call.
- **Operating the system** explains how to use the system.
- **Using the web interface** explains how to use the built-in web interface of the terminal, and describes the available menus and settings, including advanced setup of interfaces.
- **Troubleshooting** contains a short troubleshooting guide and explains how to update software. It also describes the functions of the light indicators and the Reset button, and explains the event messages that may show in the web interface. Further, it gives information on where to get help if needed.

This manual may not always reflect the latest software functionality of your SAILOR FleetBroadband system. To obtain the latest version of the manual, please enter the Thrane & Thrane Extranet and download the latest version, or acquire it from your distributor.

Related documents

The below list shows the documents related to this manual and to the SAILOR 500 FleetBroadband and SAILOR 250 FleetBroadband systems.

Title and description	Document number
SAILOR 500 FleetBroadband SAILOR 250 FleetBroadband Installation Manual Explains how to install the SAILOR FleetBroadband terminal, the SAILOR 500 FleetBroadband antenna and the SAILOR 250 FleetBroadband antenna.	TT 98-125646
SAILOR 500/250 FleetBroadband, Quick Guide A short guide to the most important functions of the SAILOR FleetBroadband systems.	TT98-125647
Thrane & Thrane IP Handset, User Manual Explains the features and functions of the Thrane & Thrane IP handset. The IP handset works as a standard IP handset, but also serves as a user interface for the SAILOR FleetBroadband systems.	TT98-126059

Typography

In this manual, typography is used as indicated below:

Bold is used for the following purposes:

- To emphasize words.
Example: “Do **not** touch the antenna”.
- To indicate what the user should select in the user interface.
Example: “Select **SETTINGS > LAN**”.

Italic is used to emphasize the paragraph title in cross-references.

Example: “For further information, see *Connecting Cables* on page...”.

Table of Contents

	Safety summary	iii
	About the manual	vi
Chapter 1	Introduction	
	Welcome	1
	In this chapter	2
	Features and interfaces	3
	Main units	4
	The Inmarsat BGAN system	11
	Matrix of services and interfaces	17
	What's next?	18
Chapter 2	Getting started	
	In this chapter	19
	Before you start	19
	Starting up the terminal	21
	Connecting the IP handset	24
	Connecting a computer	25
	Entering the SIM PIN for the terminal	26
	Registering on the BGAN network	30
	Making the first call	32
	What's next?	33
Chapter 3	Operating the system	
	In this chapter	35

General	35
Using a phone or fax machine	38
Using a computer	52
Using the IP handset	55
What's next?	55

Chapter 4 Using the web interface

In this chapter	57
Introduction	57
Entering the SIM PIN in the web interface	63
Using the Dashboard	65
Using the phone book	71
Using the Call log	76
Handling SMS messages	79
Setting up the interfaces	86
Managing LAN network users	111
Uploading software	126
Selecting the preferred BGAN satellite	131
Administration	133
Help desk and diagnostic report	148
Event logging and self test	150
What's next?	152

Chapter 5 Troubleshooting

In this chapter	153
Getting support	153

	Uploading software	154
	Part numbers	155
	Troubleshooting guide	159
	Status signaling	165
	Logging of events	182
	Reset button	183
Chapter 6	Conformity	
	SAILOR® 500 FleetBroadband	185
	SAILOR® 250 FleetBroadband	187
Glossary	189
Index	195

Introduction

Welcome

Congratulations on the purchase of your SAILOR FleetBroadband system!

SAILOR 500 FleetBroadband and SAILOR 250 FleetBroadband are maritime broadband systems, providing simultaneous high-speed data and voice communication via satellite through the Broadband Global Area Network (BGAN).



Applications include:

- Internet browsing
- E-mail
- Phone and fax services
- Large file transfers
- Video conferencing and Streaming
- VPN (Virtual Private Network) access to corporate servers

In this chapter

This chapter introduces the SAILOR 500 FleetBroadband system and the SAILOR 250 FleetBroadband system, and gives an overview of the physical units and their features and functions.

It also gives an overview of the BGAN system and services.

Features and interfaces

The SAILOR FleetBroadband system offers the following features and interfaces:

- Simultaneous voice and data communication over BGAN
- Full duplex, single or multi-user, up to:
SAILOR 500 FleetBroadband: 432 kbps
SAILOR 250 FleetBroadband: 284 kbps
- Support for streaming IP at:
SAILOR 500 FleetBroadband: 32, 64, 128, 256 kbps
SAILOR 250 FleetBroadband: 32, 64, 128 kbps
- ISDN service, only SAILOR 500 FleetBroadband: 64 kbps
- Voice: Standard Voice (4.0 kbps) or 3.1 kHz Audio
- 4 LAN (Local Area Network) ports with Power over Ethernet (PoE) for computers, e-hubs, IP handsets etc.
- 2 Standard Phone/Fax ports for standard phones, fax machines or analog modems
- 1 Euro ISDN port for ISDN phones or, for SAILOR 500 FleetBroadband only: G4 fax or ISDN modem
- 1 L-Band output for connecting a broadcast receiver for maritime data
- 1 multi-purpose I/O connector with 5 configurable inputs/outputs
- 1 SIM slot for your BGAN SIM card
- Integral DHCP/NAT router
- Built-in web interface allowing you to manage your phone book, messages and calls, and customize the terminal to your specific needs
- Input power: 10.5 - 32 V DC (14 A - 5.5 A)
- CE certified

Main units

SAILOR[®]500/ SAILOR[®]250 FleetBroadband

The main difference between the SAILOR 500 FleetBroadband system and the SAILOR 250 FleetBroadband system lies in the antenna.

- **SAILOR 500 FleetBroadband** uses the TT-3052A antenna, which is a maritime BGAN Class 8 antenna.
This antenna is larger and provides more bandwidth than the TT-3050A antenna used for the SAILOR 250 FleetBroadband system.
- **SAILOR 250 FleetBroadband** uses the TT-3050A antenna, which is a medium size, maritime BGAN Class 9 antenna.

The SAILOR 500 FleetBroadband system and the SAILOR 250 FleetBroadband system basically use the same type of terminal, except that the SAILOR 500 FleetBroadband offers a few more features than the SAILOR 250 FleetBroadband. See *Features and interfaces* on page 3.

Units overview

The **SAILOR 500 FleetBroadband system TT-3740A** includes the following main units:

- TT-3052A SAILOR 500 FleetBroadband antenna
- TT-3738A SAILOR FleetBroadband terminal
- TT-3670A IP handset with cradle

The **SAILOR 250 FleetBroadband system TT-3742A** includes the following main units:

- TT-3050A SAILOR 250 FleetBroadband antenna
- TT-3738A SAILOR FleetBroadband terminal
- TT-3670A IP handset with cradle

SAILOR[®] FleetBroadband antennas

SAILOR[®] 500 FleetBroadband *antenna*

The SAILOR 500 FleetBroadband system uses the **TT-3052A** antenna, which is a maritime BGAN antenna. The antenna contains all functions for satellite tracking, including a GPS system. A single coaxial cable carries all RF communication, supply voltage and modem communication between the antenna and the terminal.

For information on how to install the antenna, refer to the installation manual.



This antenna is larger and provides more bandwidth than the TT-3050A used for the SAILOR 250 FleetBroadband system.

SAILOR[®] 250 FleetBroadband *antenna*

The SAILOR 250 FleetBroadband system uses the **TT-3050A** antenna, which is a medium size, maritime BGAN phased array antenna.

For information on how to install the antenna, refer to the installation manual.



SAILOR® FleetBroadband terminal

Overview

Whether you have purchased a SAILOR 500 FleetBroadband system or a SAILOR 250 FleetBroadband system, the terminal is basically the same. For this reason this section covers both systems.

The SAILOR FleetBroadband terminal is the controlling unit in the SAILOR FleetBroadband system. It contains all user interfaces and LED indicators and stores configuration data. For information on how to install the terminal, refer to the installation manual.



Tools for setup and daily use

The Thrane & Thrane **IP handset** can be used for displaying status and for entering the PIN code for the terminal. The IP handset connects to the LAN interface of the terminal. For information on how to use the handset menus, see the user manual for the IP handset.

The built-in **web interface** is used for easy configuration and daily use. The web interface is accessed from a computer connected to the terminal, using an Internet browser. No installation of software is needed.

For further information on the web interface, see Chapter 4, *Using the web interface*.

SIM card

The terminal has a SIM slot (Subscriber Identity Module) located in the connector panel behind a small cover plate.

The terminal requires a dedicated FleetBroadband SIM card, which is acquired from your Airtime Provider.

The system requires a SIM card to go online and to access the settings of the terminal. However, using the web interface you can view the Dashboard and upload software without inserting a SIM card. Upload of software without a SIM card requires an Administrator user name and password.

IP handset and cradle

IP handset

The Thrane & Thrane IP handset communicates using Internet protocols. The handset is not strictly dedicated to the SAILOR FleetBroadband system, but can also be used in a public network as a standard IP telephone.

When the IP handset is used with the terminal, it communicates using Internet protocol between the handset and the terminal. However, on the BGAN network side of the terminal, calls are transmitted as circuit switched calls.

The IP handset is powered directly from the LAN interface using Power over Ethernet (PoE).



When connected to the terminal the IP handset provides a dedicated BGAN menu with a subset of the terminal configuration options.

For more information on the functions of the IP handset, refer to the user manual for the IP handset.

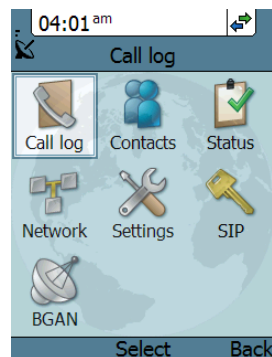

IP cradle

The IP cradle serves as a holder for the IP handset.

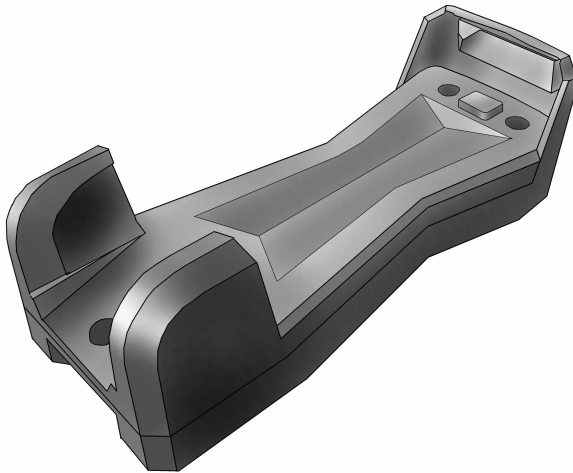

The cradle connects to the coil cord from the handset and, using an Ethernet cable, to the terminal.

The Inmarsat BGAN system

What is BGAN?

The Broadband Global Area Network (BGAN) is a mobile satellite service that offers high-speed data up to 492 kbps and voice telephony. BGAN enables users to access e-mail, corporate networks and the Internet, transfer files and make telephone calls.

The Inmarsat FleetBroadband service

FleetBroadband is a maritime communications service offered in the BGAN system. Based on 3G standards, FleetBroadband provides cost-effective broadband data and voice simultaneously.

Coverage

The Inmarsat BGAN services are based on geostationary satellites situated above the equator. Each satellite covers a certain area (footprint). The coverage map below shows the footprints of the BGAN system.

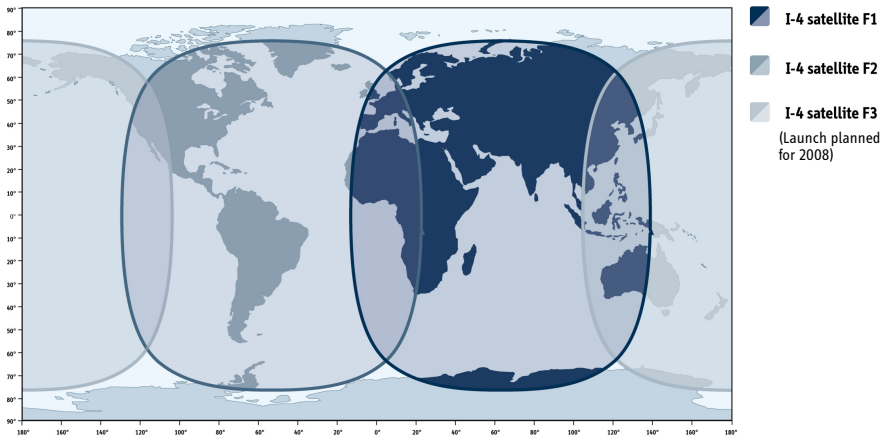

Note

The map depicts Inmarsat's expectations of coverage, but does not represent a guarantee of service. The availability of service at the edge of coverage areas fluctuates depending on various conditions.

The launch of the F3 satellite (POR) is planned for 2008.

Note

Certain FleetBroadband services are not available in areas with low elevation. For further information, see *Limitations* on page 16.

Overview of the BGAN FleetBroadband system

A complete BGAN FleetBroadband system may include the SAILOR FleetBroadband terminal with connected peripherals, a SAILOR 500 FleetBroadband antenna or a SAILOR 250 FleetBroadband antenna, the BGAN satellite, and the Satellite Access Station (SAS). The satellites are the connection between your terminal and the SAS, which is the gateway to the worldwide networks (Internet, telephone network, cellular network, etc.).

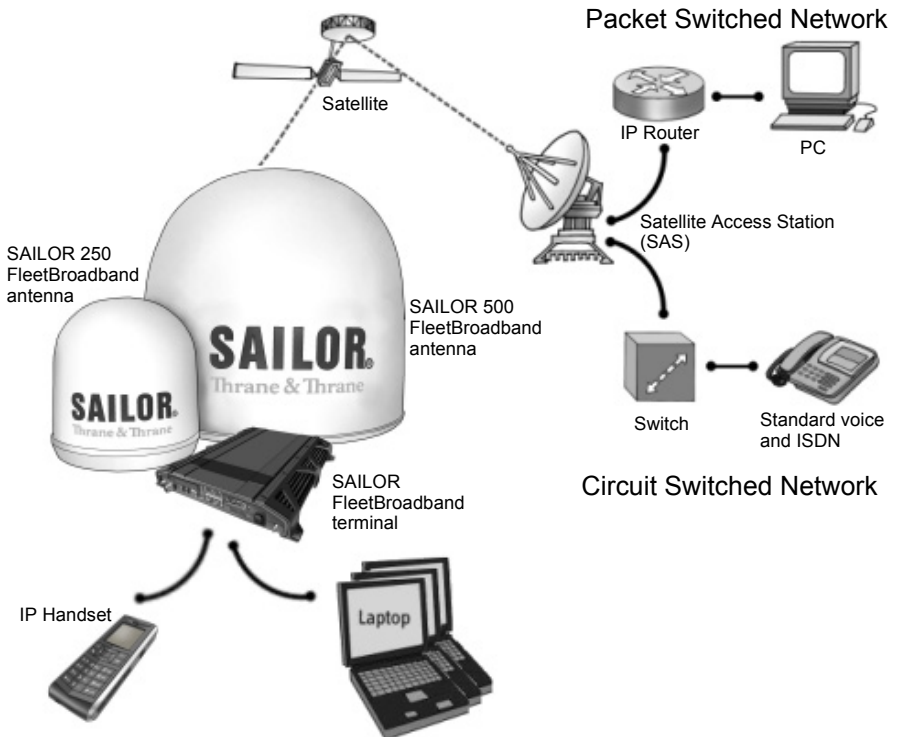

The BGAN services

Supported services

The services currently supported by BGAN comprise:

- A Packet Switched connection to the Internet
- A Circuit Switched (Dialed) connection for voice, fax or data
- Short Messaging Service (SMS)

Packet data service

The BGAN network supports different classes of data connection to the Internet.

- Using a **Standard data** connection several users can share the data connection simultaneously. This type of connection is ideal for e-mail, file transfer, and Internet and intranet access. The user pays for the amount of data sent and received.
- Using a **Streaming data** connection you get an exclusive high-priority connection ensuring seamless transfer of data. This type of connection is ideal for time critical applications like live video over IP. The user pays for the duration of the connection (per minute charge).

Note

The BGAN system supports maximum 11 concurrent PS connections at a time per SAILOR FleetBroadband system.

Circuit switched (dialed) service

The following types of circuit switched connection are available:

- **Standard Voice.** A low-tariff connection for voice only. The voice signal is compressed to 4.0 kbps, which reduces the bandwidth use and consequently the tariff.
- **3.1 kHz Audio.** A high quality connection which can be used for Premium Voice, G3 fax or analog modems. The signal is uncompressed 3.1 kHz audio, which allows for optimum voice quality.
- **ISDN.** A high quality connection which can be used for voice (3.1 kHz Audio), G4 fax or 64 kbps UDI/RDI data.

Note

The BGAN system only supports one CS call at a time per SAILOR FleetBroadband system.

SMS service

The BGAN system provides a Short Messaging Service (SMS) for sending and receiving SMS messages.

Supplementary services

The BGAN system also provides the following supplementary services:

- Call hold
- Call waiting
- Call forwarding
- Voice mail
- Call barring

Limitations

SIM lock

The supplier may SIM lock the terminal to a specific provider. For further information, contact your supplier.

Limitations in available services

The services available depend on your airtime subscription. Your SIM card may not allow for all the services described in this manual.

Further, for **FleetBroadband Class 9** (SAILOR 250 FleetBroadband), the following limitations apply:

Service	Elevation < 15	15 < Elevation < 20	Elevation ≥ 20
3.1 kHz Audio for voice and fax	Not supported	Not supported	Supported
ISDN	Not supported	Not supported	Not supported
Standard IP	Up to 284 kbps	Up to 284 kbps	Up to 284 kbps
Streaming	32, 64 kbps	32, 64, 128 kbps	32, 64, 128 kbps

For **FleetBroadband Class 8** (SAILOR 500 FleetBroadband), Streaming 256 kbps can only be guaranteed in elevations > 15°.

Matrix of services and interfaces

The following table shows which services can be accessed from which interfaces on the terminal, and which types of equipment can be used.

Service		Interface on the terminal		
		Phone/Fax	LAN (PoE)	ISDN
Circuit Switched	3.1 kHz Audio ^a	Analog telephone	IP handset	ISDN telephone
		G3 Fax machine		G3 Fax machine
		Computer with analog modem		
	Standard Voice	Analog telephone	IP handset	ISDN telephone
	Data, UDI ^a or RDI			G4 fax machine or computer with ISDN modem
Packet Switched	Data multi-user		Computer	
	Data single-user		Computer	
SMS			IP handset or computer with web interface	

- a. Notes for SAILOR 250 FleetBroadband: UDI data is not available. In low elevations (< 20°), 3.1 kHz Audio is not available.

What's next?

This chapter has provided an overview of the BGAN system and of the SAILOR FleetBroadband systems.

The next chapters will go into more detail about how to set up and use your system. The following chapter, *Getting started*, explains how to start up the system.

Getting started

In this chapter

This chapter describes how to start up the system and make the first call or data session.

For information on how to install the system, insert SIM card and connect cables, refer to the installation manual for the SAILOR 500 FleetBroadband and SAILOR 250 FleetBroadband systems.

Before you start

Operation at high temperatures

In very high ambient temperatures, do not touch areas of the terminal that are marked with this symbol.



If the terminal is installed in a location where the ambient temperature may rise above 50°C, we recommend placing the terminal where unintentional contact is avoided. Note that the maximum allowed ambient temperature is 55° C.

If the maximum ambient temperature does not exceed 50°C, the terminal can be placed in a public area.

For further information on installation, refer to the installation manual for the SAILOR FleetBroadband systems.

Connector panel

The drawing below shows the connector panel of the terminal.

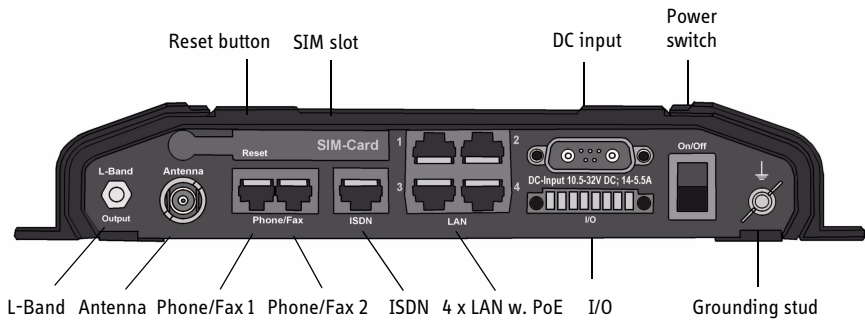

For information on how to connect to each interface, refer to the installation manual for the SAILOR 500 FleetBroadband and SAILOR 250 FleetBroadband systems.

Starting up the terminal

SIM card

Note that the SAILOR FleetBroadband terminal requires a SIM card dedicated to FleetBroadband. The terminal can only access the BGAN network when the right type of SIM card is installed. For information on how to insert the SIM card, refer to the installation manual.

Switching on the terminal

Using the Power switch

To switch on the terminal, use the Power switch in the connector panel. It normally takes one or two seconds for the terminal to switch on.

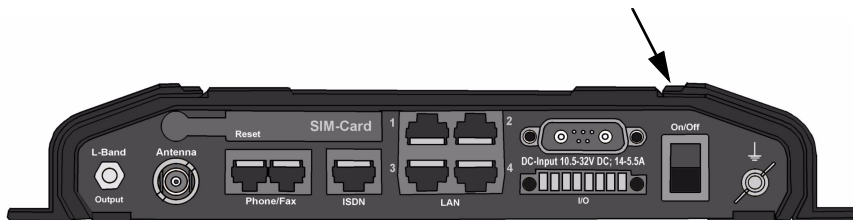

Using the ignition system

Normally the ignition function is not used in maritime installations. Instead you may want to use the remote on/off function described in the next section.

If you have connected the ignition system of your vessel to the I/O connector, you may leave the power switch in the “on” position and the terminal will switch on/off when you start/stop the engine of your vessel. When the engine is stopped the terminal is in standby mode, meaning that only the primary parts of the system are kept alive. The standby current is max. 15 mA when the ignition is off. For information on how to connect to the I/O connector, refer to the installation manual for the SAILOR 500 FleetBroadband system.

You must set up the ignition function in the web interface. For further information, see *Configuring the I/O interface* on page 110.

Using a remote on/off switch

If a switch is connected to the remote on/off pins in the DC connector, you may leave the power switch in the “on” position and use the remote switch to turn the terminal on and off. When the remote switch is off, the terminal is off. However, if you leave the power switch on the terminal in the “on” position,

you can always switch the terminal back on with the remote switch. The standby current when the remote switch is off is max. 2 mA. For further information on the remote on/off function, refer to the installation manual for the SAILOR FleetBroadband systems.

Power up completed

When the terminal is switched on, the Power indicator in the LED panel of the terminal lights green.



You can now access the terminal settings, but the terminal is not ready for making calls or running data sessions until the system is registered on the BGAN network. This normally requires that you enter a SIM PIN. For further information, see *Entering the SIM PIN for the terminal* on page 26 and *Registering on the BGAN network* on page 30.

To switch off the terminal tip the Power switch back. It takes 5 to 10 seconds to power down the terminal. Alternatively use the ignition or remote on/off function described above.

Connecting the IP handset

Power supply

The Thrane & Thrane IP handset is powered from the LAN interface, using Power over Ethernet.

Starting up the IP handset

The following procedure is for the Thrane & Thrane IP handset. The procedure may be different for another type of IP handset.

Note

The first handset that is connected to the LAN interface on the terminal is automatically registered in the terminal and assigned the local number 0501 and password 0501. For information on how to connect additional handsets, see *Connecting a new IP handset* on page 105.

Do as follows:

1. Connect the Thrane & Thrane IP handset to one of the LAN (PoE) connectors on the terminal as described in the user manual for the handset.
The handset starts up automatically.
2. If your SIM card requires a PIN and the PIN has not yet been entered in the terminal, you can enter the PIN from the BGAN menu of the IP handset.

To enter the PIN, select **BGAN > Enter PIN** from the handset menu system. Note that this menu item is only available if the terminal is waiting for a PIN. Then type in the Administrator user name and password followed by the PIN for the terminal.

For further information on the IP handset, refer to the user manual for the handset.

Connecting a computer

Before connecting to the LAN interface

For the LAN interface to work without any further setup, the connected computer must be set up to obtain an IP address and a DNS server address automatically.

Connecting a computer to the LAN interface

Do as follows:

1. Power up your computer.
2. Connect your LAN cable between the network connector on your computer and one of the LAN connectors on the terminal.
3. When the computer and the terminal are ready, check the connection e.g. by accessing the built-in web interface of the terminal with your browser. For further information, see *Accessing the web interface* on page 60. You may have to disable the Proxy server settings in your browser. For further information, see *Browser settings* on page 58.

For information on how to configure the LAN interface on the terminal, see *Configuring the LAN interface* on page 87.

Entering the SIM PIN for the terminal

Overview

Depending on your SIM card, you may have to enter a SIM PIN to use the system. You can enter the PIN using a standard phone or ISDN phone, the IP handset or the web interface.

For information on how to connect the IP handset or computer you are going to use, see *Connecting a computer to the LAN interface* on page 25 or *Connecting the IP handset* on page 24.

Entering the PIN using a phone or IP handset

To enter the PIN

If you have a phone connected to the terminal, you can use it to enter the PIN at start up.

Do as follows:

Dial the PIN the same way you would dial a phone number:

- **For an analog or ISDN phone:**
Pick up the phone. When the terminal is waiting for a PIN, you will hear 2 beeps - pause - 2 beeps - etc.
Dial <PIN> followed by #.
When you hear a “busy” tone or a dialing tone, the PIN has been accepted and you can hang up or dial a number.
- **For an IP handset:**
Select the **BGAN** menu, select **Enter PIN** and enter the user name and password for the terminal. Then enter the PIN for the terminal.
Note that the menu item “Enter PIN” is only available if the terminal is waiting for a PIN.

Wrong PIN

Analog phone or ISDN phone: If, instead of the busy tone or dialing tone, you continue to hear 2 beeps - pause - 2 beeps - etc., it means the PIN was not accepted. Check that you have the correct PIN and try again.

If a wrong PIN has been entered three times, you will hear 3 beeps - pause - 3 beeps - etc. This means you have to enter the PUK (PIN Unblocking Key) provided with your SIM card.

After entering the PUK, you must enter a new PIN of your own choice (4 to 8 digits long).

Dial the following:

<PUK> * <New PIN> * <New PIN> followed by # or off-hook key.

Example: If the PUK is 87654321 and the new PIN is 1234, dial
87654321 * 1234 * 1234 followed by # or off-hook key.

If you enter 10 wrong PUKs, the SIM card will no longer be functional. Contact your Airtime Provider for a new SIM card.

IP handset: After having entered the user name and password for the terminal you have 3 attempts to enter the SIM PIN, before you are asked to enter the PUK (Pin Unblocking Key). The PUK is supplied with the SIM card for your terminal.

Enter the PUK followed by a new PIN of your own choice. The PIN must be from 4 to 8 digits long.

If you enter a wrong PUK 10 times, the SIM card will no longer be functional, and you have to contact your Airtime Provider for a new SIM card.

Entering the PIN using the web interface

To enter the PIN

Do as follows:

1. On a computer connected to the terminal, open your browser and enter the IP address of the terminal. Refer to *Using the web interface* on page 57. The default IP address is **192.168.0.1**.

If your SIM card uses a PIN and the PIN has not yet been entered, the web interface will open on the PIN page.

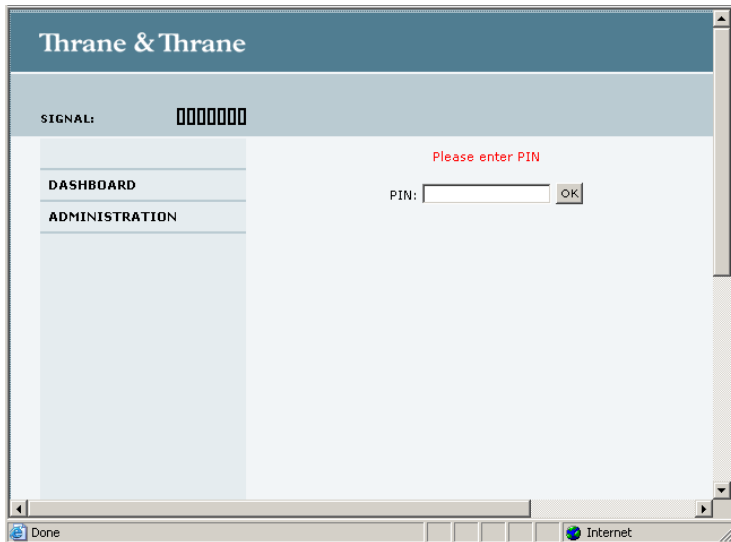

2. Type in the PIN and click **OK**.
When the PIN is accepted, the web interface opens the Dashboard and is ready for use. If the PIN is not accepted, see the next section *Wrong PIN*.

Wrong PIN

You have 3 attempts to enter the PIN in the web interface, before you are asked to enter the PUK (Pin Unblocking Key). The PUK is supplied with your SIM card.

Enter the PUK followed by a new PIN of your own choice. The PIN must be from 4 to 8 digits long.

If you enter a wrong PUK 10 times, the SIM card will no longer be functional, and you have to contact your Airtime Provider for a new SIM card.

Registering on the BGAN network

Registration procedure

When the SIM PIN is accepted by the terminal, the SAILOR FleetBroadband system starts the registration procedure on the BGAN network.

Note

We recommend keeping the vessel on a steady course while the antenna is performing a sky scan. If the vessel is turning during sky scan, it increases the total duration of the sky scan process.

You can monitor the registration procedure by looking at the Antenna and Terminal indicators in the LED panel of the terminal.

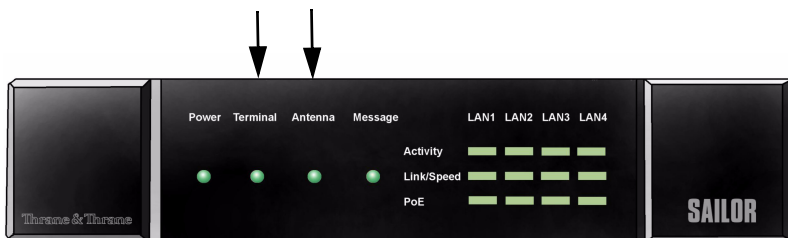

Note that the registration procedure may take several minutes. The table on the next page shows the normal sequence.

LED indications during the registration procedure

This table shows how the startup procedure is signaled with the light indicators. If an error occurs, the indicators will light yellow or red, depending on the severity of the error.

Status	Antenna indicator	Terminal indicator
The antenna is starting up	Flashing slowly green	
The antenna is performing a sky scan	Flashing rapidly green	
The terminal is registering on the network		Flashing green
The antenna is tracking.	Steady green	
The system is registered and ready for use.	Steady green	Steady green

For further information on the indicators, see *Light indicators* on page 166.

Making the first call

Introduction

When the Antenna and Terminal indicators in the LED panel on the terminal both light steady green, you are ready to make or receive the first call.

The following sections provide a short guide to making calls. For more detailed information, see *Making or receiving a phone call* on page 42.

Making a call from the terminal

To make a call from a phone or handset connected to the terminal, dial

00 <country code> <phone number> followed by **#** or off-hook key.

Example: To call Thrane & Thrane in Denmark (+45 39558800) from an analog phone,
dial **00 45 39558800 #**

Making a call to the terminal

Note

By default all handsets connected to the terminal will ring on incoming calls. If you have connected a fax, set the incoming call type on that Phone/Fax interface to 3.1 kHz Audio to avoid that the fax rings and answers an incoming Standard call. For further information, see *Selecting the call type* on page 39.

To make a call to a phone connected to the terminal, dial

+ <Mobile number>

- **+** is the prefix used in front of the country code for international calls.

- **Mobile number:** The mobile number of the terminal you are calling. The first part of the number is always 870, which is the “country code” for the BGAN system.

Note

There are two Voice numbers, one for 3.1 kHz Audio and one for Standard Voice.

Example: If you are calling from Denmark and the mobile number for 3.1 kHz Audio is 870782105234 on your terminal, and you want to make a call to the terminal using 3.1 kHz Audio, dial **00 870 782105234**.

If the mobile numbers are listed in the web interface, you can look them up by selecting **PHONE BOOK > Mobile numbers**.

If the numbers are not listed, refer to your airtime subscription. We recommend using the web interface to save the mobile numbers for future reference. See *Viewing and editing the mobile numbers* on page 75.

Making a call from one terminal to another

To make a call from one terminal to another, dial **00 <Mobile number>**.

What's next?

After reading this chapter you should be able to start up the terminal and make a simple data or voice connection.

The next chapters provide more information on the user interfaces and the setup of the terminal. The following chapter, *Operating the system*, explains how to use the system.

Operating the system

In this chapter

This chapter describes how to use the SAILOR FleetBroadband systems.

It does not describe advanced configuration of interfaces. For this type of information, refer to the “Configuring...” sections for the interfaces in Chapter 4, *Using the web interface*.

General

Tools for setup and use

Overview

You can use the **Thrane & Thrane IP handset** for viewing status, using the phone book of the terminal and for entering the PIN, but for enhanced use and for configuration of interfaces, you need to connect a computer.

With a computer and a browser, you can use the built-in **web interface** to set up the terminal.

The IP handset

When you connect the Thrane & Thrane IP handset to one of the LAN (PoE) connectors on the terminal you can use the handset display and keypad to enter the PIN or to view the status of the terminal.

The IP handset includes the following items for the terminal:

- Viewing C/No (signal strength) and status (“Ready”, “Registering” etc.) for the SAILOR FleetBroadband system.
- Viewing the IP address and software version of the terminal.
- Viewing the IP handset settings from the terminal.
- Entering the PIN and PUK for the terminal.
- Inclusion of the SAILOR FleetBroadband phone book (not editable) in the IP handset Contacts.

For further information on the IP handset, see the user manual for the IP handset.

The web interface of the terminal

The web interface is a built-in web server for setting up and controlling the terminal, using a connected computer with a browser. No installation of software is required.

With the web interface you can access the same settings as with the IP handset, and additionally:

- edit the phone book
- view information on calls to/from the terminal
- view properties of the terminal and antenna
- set up the interfaces of the terminal
- upload software
- set up user rights (requires Administrator password)
- set up network user groups (requires Administrator password)

For information on how to use the web interface, see *Using the web interface* on page 57.

Services and interfaces

The following table shows the possible combinations of services and interfaces, and which types of equipment can be used.

Service		Interface on the terminal		
		Phone/Fax	LAN (PoE)	ISDN
Circuit Switched	3.1 kHz Audio ^a	Analog telephone	IP handset	ISDN telephone
		G3 Fax machine		G3 Fax machine
		Computer with analog modem		
	Standard Voice	Analog telephone	IP handset	ISDN telephone
	Data, UDI ^a or RDI			G4 fax machine or computer with ISDN modem
Packet Switched	Data multi-user		Computer	
	Data single-user		Computer	
SMS			IP handset or Computer with web interface	

- a. Notes for SAILOR 250 FleetBroadband:
 UDI data is not available.
 In low elevations (< 20°), 3.1 kHz Audio is not available.

Using a phone or fax machine

Available interfaces

Three types of voice equipment connect to the terminal:

Standard analog phone or G3 fax machine: The terminal has two phone connectors for connecting standard analog phones or fax machines.

IP handset: The terminal has four LAN connectors with Power over Ethernet for connecting IP handsets or other IP equipment. For information on the features and functions of the Thrane & Thrane IP handset, refer to the user manual for the handset.

ISDN phone or G4 fax machine: The terminal has one ISDN connector for connecting an ISDN phone, a modem or a fax machine. Note that only SAILOR 500 FleetBroadband supports G4 fax (UDI).

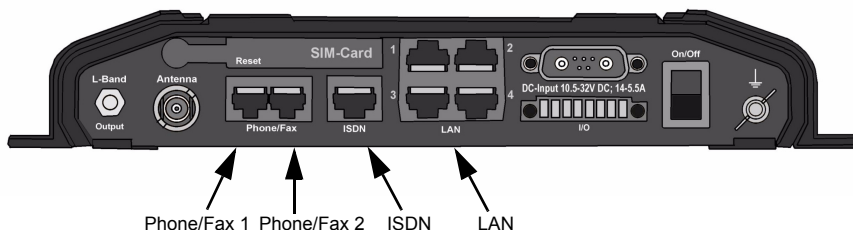

For information on how to connect to the interfaces, see the installation manual for the SAILOR 500 FleetBroadband and SAILOR 250 FleetBroadband systems.

Selecting the call type

Definition

The phone connection can use one of the following call types:

- **Standard Voice**, which is a low-tariff voice connection compressed to 4.0 kbps,
- **3.1 kHz Audio**, which is a high quality connection used for Premium Voice, G.3 fax or analog modem,
- **UDI or RDI** (only on ISDN interface), which is used for G4 fax or data.

In the web interface you can set up which type of connection to use by default when you make or receive a call from the Phone/Fax or ISDN interface or from an IP handset connected to the LAN interface.

When connecting a fax or a modem to the Phone/Fax interface you must use 3.1 kHz Audio.

Example: If you always have a fax connected to the same Phone/Fax interface you can set this interface to 3.1 kHz Audio only. This will mean that if an incoming Standard Voice call is received, this Phone/Fax interface will not ring.

When connecting a G4 fax or a modem to the ISDN interface in the SAILOR 500 FleetBroadband system you must use UDI.

Note

UDI and RDI are **not available** with the SAILOR 250 FleetBroadband system, so you cannot connect a G4 fax machine nor a modem to the ISDN interface on the SAILOR 250 FleetBroadband system.

Selecting the default outgoing call type

To select the default call type for outgoing calls, do as follows:

- **ISDN.** Select the call type in the web interface under **SETTINGS > ISDN**. For further information, see *Configuring the ISDN interface* on page 92.
- **Phone/Fax.** Select the call type for each port in the web interface under **SETTINGS > Phone/Fax**.

For further information, see *Configuring the Phone/Fax interface* on page 90.

- **IP handset.** Select the call type for each handset in the web interface under **SETTINGS > IP Handset > Call settings**. For further information, see *Setting the call types for IP handsets* on page 108.

Overriding the default outgoing call type

To override the default setting for a specific outgoing call, do as follows:

- To use **Standard Voice** for the call, dial **1*** before the number.
- To use **3.1 kHz Audio** for the call, dial **2*** before the number.

Example: To make a call to Thrane & Thrane in Denmark (+45 39558800), forcing the connection to use Standard Voice, dial **1* 0045 39558800** followed by **#** if calling from an analog or ISDN phone, or off-hook key if calling from an IP handset.

Note

This will not change the default call type, only the type used for the ongoing call.

Phone numbers for incoming 3.1 kHz Audio and Standard Voice

3.1 kHz Audio and Standard Voice have separate phone numbers. This way, a person calling a phone connected to the terminal can select whether to use 3.1 kHz Audio or Standard Voice, simply by using the dedicated phone number.

Note | The call type you are using must be selected in the web interface (refer to the next section).

If the mobile numbers are listed in the web interface, you can look them up as follows:

Connect a computer, access the web interface and select **PHONE BOOK > Mobile numbers**. For further information, see *Viewing and editing the mobile numbers* on page 75.

If the mobile numbers are not available in the web interface, refer to your airtime subscription.

Note | There are two Voice numbers, one for 3.1 kHz Audio and one for Standard Voice.

For information on how to make a call to the terminal, see *Making a call to the terminal* on page 44.

Selecting the incoming call type

To select which call types are accepted for an incoming call, use a computer and the web interface.

- **ISDN.** Select the call type under **SETTINGS > ISDN**. For further information, see *Configuring the ISDN interface* on page 92.
- **Phone/Fax.** Select the call type for each port under **SETTINGS > Phone/Fax**. For further information, see *Configuring the Phone/Fax interface* on page 90.
- **IP handset.** Select the call type for each handset in the web interface under **SETTINGS > IP Handset > Call settings**. For further information, see *Setting the call types for IP handsets* on page 108.

Making or receiving a phone call

Analog phone, ISDN phone or IP handset

There are different methods for activating a call, depending on the type of phone:

- **Analog phone or ISDN phone:** Dial # after the number.
- **IP handset:** Press the off-hook key after the number.

Making a call

First connect your phone to the relevant interface. For further information, see the Installation Manual.

You have different options for making a call:

- **Short Dial.** If the number is in the phone book of the terminal, you can use the Short Dial number, which is found in the first column of the phone book in the web interface. See *Short dial* on page 73.

Simply dial **00 <Short Dial>** followed by **#** or off-hook key.

Example: To call entry number 4 in the phone book, dial **004** followed by **#** or off-hook key.

- **Manual Dial.** To make a call, dial **00 <country code> <phone number>** followed by **#** or off-hook key.

Example: To call Thrane & Thrane in Denmark (+45 39558800) from an analog or ISDN phone, dial **00 45 39558800 #**

- **Call from phone book or call log** (only IP handset).
 - Enter the phone book of the IP handset, scroll to the wanted number and press the off-hook key, or
 - press the off-hook key from the main screen to display the latest calls in the call log. Then scroll to the wanted number and press the off-hook key again.

Note that this is the call log of the IP handset, not of the terminal.

If there was an error establishing the connection, refer to the *Troubleshooting Guide* on page 159.

If you are using the IP handset, the handset may show an error message. Depending on the type of error, the web interface may also show an error message. See *Viewing the Event list or the Event log* on page 150.

Receiving a call

To be able to receive a call, the phone must be connected to the relevant interface on the terminal.

By default, all devices connected to the Phone/Fax interface, the ISDN interface or the LAN (PoE) interface will ring when one of the mobile numbers is called. Note, however, that this depends on the call type settings. Refer to *Selecting the incoming call type* on page 41.

Call log

Information of missed calls is stored in the call log of the terminal. You can view the call log in the web interface under **CALLS**. For further information, see *Viewing the lists of calls* on page 77.

Making a call to the terminal

To make a call to a phone connected to the terminal, dial

+ <**Mobile number**>

- + is the prefix used in front of the country code for international calls.
- **Mobile number.** The first part of the mobile number is always 870, which is the “country code” for the BGAN system. If the mobile numbers are listed in the web interface, you can look them up as follows:

Connect a computer, access the web interface and select **PHONE BOOK > Mobile numbers**. For further information, see *Viewing and editing the mobile numbers* on page 75.

If the mobile numbers are not available in the web interface, refer to your airtime subscription.

Note

There are two Voice numbers, one for 3.1 kHz Audio and one for Standard Voice.

Dialing functions

Special-purpose numbers

There are a number of dialing functions available in the terminal. The following list shows the allocated special-purpose numbers for the terminal.

Number	Function
0 * followed by # or off-hook key	Redial last called number on this interface.
00 * followed by # or off-hook key	Redial last answered call on this interface. Note: If the last answered number is an unlisted number, you will not be allowed to dial back.
00 followed by one of the numbers 1-199 and # or off-hook key	Short dial phone numbers in phone book.
0300 followed by # or off-hook key	Local call broadcast to both analog phones.
0 followed by one of the numbers 301-302 and # or off-hook key	Local call to analog phone.
0400 followed by # or off-hook key	Local call broadcast to all ISDN phones.
0 followed by one of the numbers 401-402 and # or off-hook key	Local call to ISDN phone.
0500 followed by # or off-hook key	Local call broadcast to all IP handsets.
0 followed by one of the numbers 501-516 and # or off-hook key	Local call to IP handset.
0900 followed by # or off-hook key	Local call broadcast to all handsets.

Dialing prefixes

Apart from the numbers above, the terminal uses the following dialing prefixes:

- **1*** before the phone number will force the connection to use **Standard Voice**.
- **2*** before the phone number will force the connection to use **3.1 kHz Audio**.
- **#31#** before the phone number will hide the callers phone number to the recipient.
- ***31#** before the phone number will show the callers phone number to the recipient where it would otherwise be hidden, e.g. because the number is an ex-directory number.
- **R** is used during a call to indicate that the following key-presses should activate a supplementary services function. The supplementary services functions supported by the terminal are described in the subsequent sections.

Making local phone calls

You can make local calls between various phones connected to the terminal.

Local phone numbers always start with 0.

For an overview of the numbers, see *Special-purpose numbers* on page 45.

To make a local call, dial

<local number> followed by **#** or off-hook key.

Local numbers of analog phones, ISDN phones and IP handsets are assigned according to the table in *Special-purpose numbers* on page 45. Note that if you are using local numbers for ISDN devices, the numbers must be programmed in the devices. For further information refer to the documentation for your ISDN device.

Handling waiting calls

Note | The phone must have an R key to be able to use these functions.

During a call, if a second party attempts to make contact with you, you may hear a Call Waiting indication. The Call Waiting indication is two beeps and a pause of 3 seconds, then two beeps again etc. If no action is taken, the waiting call is released after a time out period.

In the web interface you can enable or disable the call waiting indication. For further information, see *Call waiting* on page 100.

When you receive a Call Waiting indication, you have the following options:

If you want to:	Do as follows:
Clear the current call, and accept the waiting call.	Press R 1 # , within the time out period.
Hold the current call, and accept the waiting call.	Press R 2 # , within the time out period.
Ignore the waiting call.	Take no action.
Reject the waiting call.	Press R 0 # , within the time out period.

Note | The BGAN system only supports one external call at a time.

Holding a call

Note | The phone must have an R key to be able to use these functions.

During a call, you may place the initial call on hold while another call is made.

If you want to:	Do as follows:
Place a call on hold.	Press R 2 # .
Place the existing call on hold and establish a new call.	Press R and dial the second phone number followed by # .
Shuttle between the two calls.	Press R 2 # (irrespective of whether the second call was acquired using Call Hold or acceptance of Call Waiting.)
Clear the held call, if no waiting call exists.	Press R 0 # .
Clear an active call and return to the held call.	Press R 1 # . Note that this is only possible if no waiting call exists.

Note | The BGAN system only supports one external call at a time.

Transferring a call

Note | The phone must have an R key to be able to use these functions.

When you receive a call, you can transfer this call to another phone connected to the terminal.

To transfer the incoming call to another phone or headset, do as follows:

1. Press **R 4 * <local number> #**.
The phone with the local number you dialed starts to ring.
2. You now have two options.
 - Hang up. The phone or headset you transferred the call to continues to ring. When the call is answered, a connection is established between the initial caller and the new recipient.
 - Do not hang up. When the new recipient answers, you can have a conversation before hanging up. When you hang up, the call is handed over to the initial caller.

Note | The BGAN system only supports one external call at a time.

Sending or receiving a fax message

Handling delays

When sending or receiving fax messages over satellite, both fax units must be capable of handling longer delays without timing out. Some fax machines have an Overseas mode, which enables the unit to handle the long delays.

Sending a fax message from the terminal

Note

If the default setting in the web interface is not 3.1 kHz Audio, you can dial 2 * before the number, to force the connection to use 3.1 kHz Audio. For further information, see *Overriding the default outgoing call type* on page 40.

The fax machine must be connected to the Phone/Fax interface or the ISDN interface of the terminal. Refer to the installation manual.

3.1 kHz Audio must be used for an analog fax machine. Refer to *Selecting the default outgoing call type* on page 39.

UDI must be used for an ISDN G4 fax machine, Note that this is not possible in a SAILOR 250 FleetBroadband system. Refer to *Configuring the ISDN interface* on page 92.

To send a fax from a fax machine connected to the terminal, dial

00 <country code> <phone number> #

Example: To send a fax to Thrane & Thrane in Denmark (+45 39558888), dial **00 45 39558888 #**

Sending a fax message to the terminal

To send a fax message to the terminal, dial

+ <Mobile number> #

- + is the prefix used in front of the country code for international calls.
- **Mobile number.** The first part of the mobile number is always 870, which is the “country code” for the BGAN system. Use the 3.1 kHz mobile number if you are calling a G3 fax and the UDI number if you are calling an ISDN G4 fax connected to the terminal. If the mobile numbers are listed in the web interface, you can look them up as follows:

Connect a computer, access the web interface and select **PHONE BOOK > Mobile numbers**. For further information, see *Viewing and editing the mobile numbers* on page 75.

If the mobile numbers are not available in the web interface, refer to your airtime subscription.

Note

There are four mobile numbers, one for 3.1 kHz Audio, one for Standard Voice, one for UDI and one for RDI.

Receiving a fax message

An analog fax machine connected to the terminal can only receive a fax with 3.1 kHz Audio. Refer to *Selecting the incoming call type* on page 41.

An ISDN G4 fax machine connected to the SAILOR 500 FleetBroadband terminal can only receive a fax with UDI. SAILOR 250 FleetBroadband does not support UDI and cannot be used with a G4 fax machine.

Using a computer

Interfaces

The terminal has four LAN connectors for connecting computers or other LAN equipment.

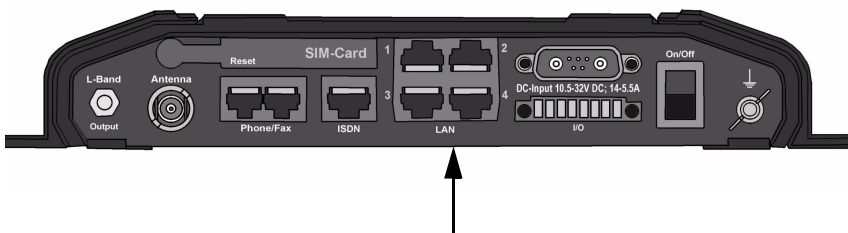

For information on how to connect to the interfaces, see the installation manual for the SAILOR 500 FleetBroadband and SAILOR 250 FleetBroadband systems.

Standard or Streaming data on LAN

Definition

The BGAN network supports different classes of data connection to the Internet. The main classes are Standard data and Streaming data.

- Using a **Standard data** connection, several users can share the data connection simultaneously. This type of connection is ideal for TCP/IP traffic such as e-mail, file transfer, and Internet and intranet access. The user pays for the amount of data sent and received.
- Using a **Streaming data** connection, you get an exclusive, high-priority connection, ensuring seamless transfer of data. This type of connection is

ideal for time critical applications like live video over IP.
The user pays for the duration of the connection (per minute charge).

Note For optimum performance it is important that you select the right traffic class when defining profiles for your connection.

You can set up various types of connection using the profiles and traffic flow filters. For further information, see *Using profiles* on page 139 and *Using traffic flow filters* on page 143.

Setting up and activating a Streaming connection

The SAILOR 250 FleetBroadband system supports 32, 64 and 128 kbps Streaming.

The SAILOR 500 FleetBroadband system supports 32, 64, 128 and 256 kbps Streaming.

Note You may have difficulties establishing the fastest Streaming connection if you are located close to the edges of the satellite beam. 256 kbps Streaming on SAILOR 500 FleetBroadband and 128 kbps Streaming on SAILOR 250 FleetBroadband normally require an elevation angle of more than 15 degrees.

By default, any data connection on the terminal is a Standard data connection.

If you want to set up a Streaming connection, select a Streaming profile when setting up your network user group. See *Managing LAN network users* on page 111.

To start or stop a Streaming session on the LAN interface, do as follows:

1. Access the web interface.
2. In the **Dashboard**, locate the field **STREAMING PROFILES ON LAN**.

3. Click the **Start** or **Stop** link of the relevant Streaming profile.

Note

If another primary profile is active you must stop it before you can start your new profile.

Note

When running a Streaming session you are charged for the time you are connected. A started Streaming session will stay active until you stop it.

For further information, see *Using profiles* on page 139 and *Setting up the network user groups* on page 113.

Working with network groups

The LAN users of the SAILOR FleetBroadband system can be organized in network user groups with different setup and different access rights.

Users can only see and start/stop profiles configured for their own network user group.

Using the built-in web interface with an Administrator password you can configure the network user groups and network devices.

For further information, see *Managing LAN network users* on page 111.

Using the IP handset

You can use the Thrane & Thrane IP handset as user interface for the SAILOR FleetBroadband system as well as for making calls or sending SMS messages.

The IP handset has a dedicated menu for the SAILOR FleetBroadband system.

For information on how to start up the IP handset, see *Connecting the IP handset* on page 24.

For further information on how to use the IP handset, refer to the IP Handset User Manual.

What's next?

This chapter has described the basics of how to use the SAILOR FleetBroadband system.

The following chapter, *Using the web interface*, describes how to use the built-in web interface for setting up and using the system.

Using the web interface

In this chapter

This chapter describes how to use the web interface to operate, set up and configure your SAILOR FleetBroadband system.

Introduction

The web interface

What is the web interface?

The web interface is built into the terminal, and is used for operating, setting up and configuring the system.

You can access the web interface from a computer with a standard Internet browser. Internet Explorer 6.0, Mozilla Firefox 1.0 and Apple Safari 2.0 were tested successfully with the web interface. You may be able to use other browser versions as well.

Connecting

Connect your computer to the terminal, using the LAN interface. For information on how to connect to the LAN interface, see the installation manual.

To access the web interface, an Internet browser must be installed on the computer.

Browser settings

If you are connecting your computer using the LAN interface, the **Proxy server** settings in your browser must be disabled before accessing the web interface.

Most browsers support disabling of the Proxy server settings for one specific IP address, so you can disable Proxy server settings for the web interface only, if you wish. Consult your browser help for information.

To disable the use of a Proxy server completely, do as follows:

Note

The following description is for **Microsoft Internet Explorer**. If you are using a different browser, the procedure may be different.

1. In Microsoft Internet Explorer, select **Tools > Internet Options > Connections > LAN Settings**.

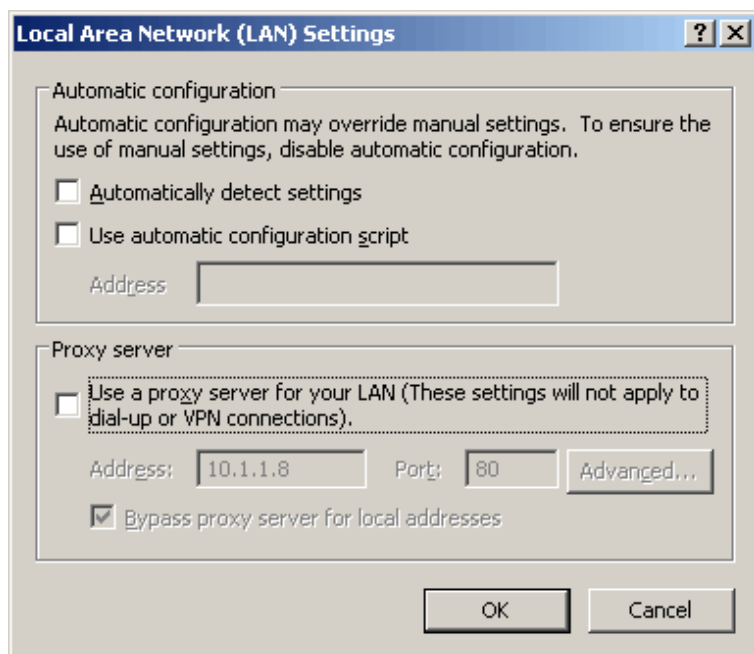

2. Uncheck the box labeled **Use a proxy server for your LAN**.
3. Click **OK**.

When the proxy server settings are disabled, close your browser.

You may need to change this setting back on return to your Internet connection.

Accessing and navigating the web interface

Accessing the web interface

To access the web interface, do as follows:

1. Connect your computer to the terminal.
2. Start up the terminal.
For further information, see *Getting started* on page 19.
3. Open your browser and enter the IP address of the terminal.
The standard IP address is **192.168.0.1**.

Note

If the IP address is changed and you do not have the new address, you can temporarily set the IP address to the default value by pressing the **Reset** button next to the SIM slot in the connector panel of the terminal. You can then access the web interface and change the IP address.

Note that if you do not change the IP address, the default IP address will only be valid until the terminal is powered off. Then the terminal returns to the IP address from before the Reset button was pressed.

For further information on the Reset button, see *Reset button* on page 183.

Overview of the web interface

When the web interface opens, the title bar shows the name of the product.

Note

If no antenna is connected, the web interface will assume that the system is a SAILOR 500 FleetBroadband system.

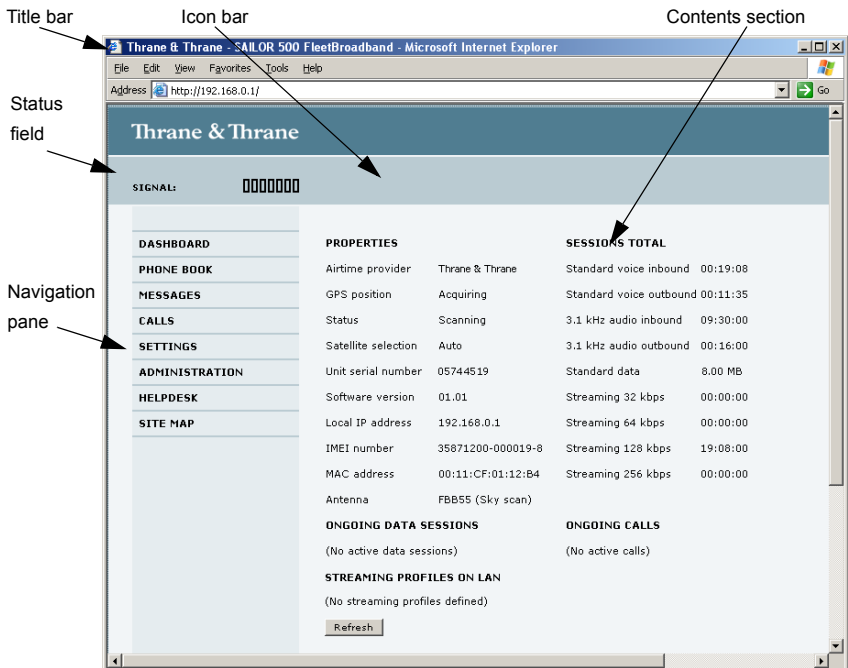

The web interface consists of the following sections.



- The **navigation pane** holds the main menu. Clicking an item in the menu opens a submenu in the navigation pane or a new page in the contents section.
- The **status field** shows the signal strength.
- The **icon bar** shows icons for new SMS messages and for active events, when relevant. For explanations of the icons, see the next section, *Icons in the icon bar*.
- The **contents section** shows the page selected in the navigation pane. This section is used for viewing or changing settings, or for performing actions.

Icons in the icon bar

The following icons may appear in the icon bar in the web interface:

Icon	Explanation
	<p>A new SMS message, or information of Voice mail, has arrived.</p> <p>Click the icon to see new messages or information of Voice mail. For further information, see <i>Receiving a message</i> on page 82.</p>
	<p>An event is active.</p> <p>Click the icon to see a list of active events. For explanations of the event messages, see <i>List of events</i> on page 171.</p> <p>Note that this icon will remain in the icon bar as long as the event is still active.</p>

Navigating the web interface

- **To expand a menu**, click the menu in the navigation pane.
- **To access status and settings**, click the relevant subject in the navigation pane or click the relevant icon in the icon bar. The status or settings are displayed in the contents section.
- **To see the site map**, click **SITE MAP** in the navigation pane. Click on items in the site map to go directly to the relevant location.

Entering the SIM PIN in the web interface

Note

You may not have to enter a SIM PIN to access the terminal. This depends on whether or not the use of a SIM PIN is enabled on your SIM card.

If a computer is connected when you start up the terminal, you can access the web interface and enter the SIM PIN here.

If your SIM card requires a PIN, and the PIN has not yet been entered: When you access the web interface, it opens on the PIN page. Until you enter the PIN you can only upload software and view the Dashboard. Access to all other parts of the web interface requires a PIN.

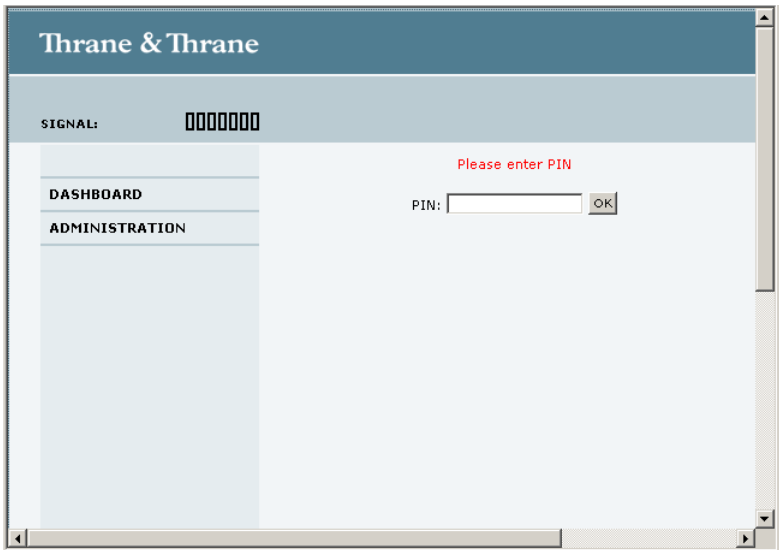

Type in the PIN and click **OK**.

If you enter a wrong PIN 3 times you are asked for a PUK (PIN Unblocking Key). For further information, see *Wrong PIN* on page 29.

If the PIN has already been entered in the terminal, or the PIN is disabled, the web interface goes directly to the Dashboard at start-up.

When the correct PIN is entered, the web interface opens the Dashboard and is ready for use.

Note

Some parts of the web interface may be greyed out if the user permissions are limited. For information on how to set up user permissions, see *Setting up user permissions* on page 146.

Using the Dashboard

Overview

The Dashboard is used for control and inspection of ongoing communication and for viewing properties and status of the terminal and antenna.

The screenshot shows the Thrane & Thrane web interface. At the top, the signal strength is indicated by six bars. A navigation menu on the left includes: DASHBOARD, PHONE BOOK, MESSAGES, CALLS, SETTINGS, ADMINISTRATION, HELPDESK, and SITE MAP. The main content area is divided into several sections:

- PROPERTIES:**
 - Airtime provider: Thrane & Thrane
 - GPS position: Acquiring
 - Status: Scanning
 - Satellite selection: Auto
 - Unit serial number: 05744519
 - Software version: 01.01
 - Local IP address: 192.168.0.1
 - IMEI number: 35871200-000019-8
 - MAC address: 00:11:CF:01:12:B4
 - Antenna: FBB55 (Sky scan)
- SESSIONS TOTAL:**
 - Standard voice inbound: 00:19:08
 - Standard voice outbound: 00:11:35
 - 3.1 kHz audio inbound: 09:30:00
 - 3.1 kHz audio outbound: 00:16:00
 - Standard data: 8.00 MB
 - Streaming 32 kbps: 00:00:00
 - Streaming 64 kbps: 00:00:00
 - Streaming 128 kbps: 19:08:00
 - Streaming 256 kbps: 00:00:00
- ONGOING DATA SESSIONS:** (No active data sessions)
- STREAMING PROFILES ON LAN:** (No streaming profiles defined)
- ONGOING CALLS:** (No active calls)

A "Refresh" button is located at the bottom of the main content area. The browser's address bar shows "Internet".

Properties

The **PROPERTIES** section of the **DASHBOARD** shows the following information:

- **Airtime provider.** The name of your Airtime Provider.
- **GPS position.** The GPS position of your SAILOR FleetBroadband system.

Note

In some cases, the BGAN network does not allow the position to be displayed to the user. If this is the case, the display may just show **GPS acquired**. This means that the GPS position is received, but the user is not allowed to see it.

This also applies if the SAILOR FleetBroadband is not yet registered on the BGAN network, but the GPS position is received.

- **Status.** The status of the terminal and antenna.
Examples of status information are: Scanning, Ready and Data active.
- **Satellite selection.** The satellite selected for logon. For further information, see *Selecting the preferred BGAN satellite* on page 131.
- **Unit serial number.** The serial number of the terminal.
- **Software version.** The version of the software embedded in the terminal.
- **Local IP address.** The local IP address of the terminal. This is the IP address used to access the terminal from a device connected to the terminal.
- **IMEI number.** The IMEI number (International Mobile Equipment Identity) of the terminal. This is a unique number that identifies your terminal.
- **MAC address** for the LAN interface in the terminal.
- **Antenna.** The type of antenna connected to the terminal, and the status of the antenna.

Managing data sessions

Overview

Data sessions are displayed under **PROFILES ON LAN** or **STREAMING PROFILES ON LAN** at the bottom of the **Dashboard**.

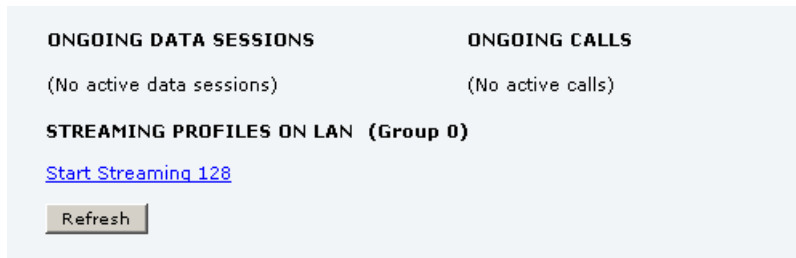

The screenshot shows a dashboard section with two columns. The left column is titled "ONGOING DATA SESSIONS" and contains the text "(No active data sessions)". The right column is titled "ONGOING CALLS" and contains the text "(No active calls)". Below these columns, there is a section titled "STREAMING PROFILES ON LAN (Group 0)" which includes a blue link "Start Streaming 128" and a "Refresh" button.

- Primary profiles are listed in the left side and secondary profiles (if any) are listed to the right.
- Profiles that are currently active are displayed as a link with the text “Stop <name of profile>”.
- Profiles that are ready to be activated are displayed as a link with the text “Start <name of profile>”.

Start/stop a Streaming session on the LAN interface

Note

Before starting a Streaming session, make sure you have set up a Streaming profile for your user group in the SETTINGS > LAN > Network user groups page.

To start or stop a Streaming session, click the link with the name of your Streaming profile under **STREAMING PROFILES ON LAN**.

Note that if another primary profile is active you must stop it before you can start your new profile!

If a primary profile is already active, your new profile will not appear as a link but as plain text. The active primary profile is displayed as a link with the text “Stop <name of profile>”. Click this link first to stop the active profile. Then click your new profile, which is now displayed as a link.

Important

If you have selected a Streaming connection as your primary profile, the LAN interface will be running a Streaming connection until you stop it or disconnect the interface. However, if you select one or more secondary profiles, you can set up your traffic flow filter so that it will only use the Streaming profile for certain types of traffic.

For information on setup of the network user groups, see *Managing LAN network users* on page 111. For information on how to set up a profile, see *Using profiles* on page 139.

Note

You may have difficulties establishing the fastest Streaming connection if you are located close to the edges of the satellite beam. 256 kbps Streaming on SAILOR 500 FleetBroadband and 128 kbps Streaming on SAILOR 250 FleetBroadband normally require an elevation angle of more than 15 degrees.

Start/stop Standard data on the LAN interface

By default, Standard data is always activated on the terminal. If you only want Standard data to be activated when you have specifically enabled it, you can disable automatic activation using the SETTINGS > LAN > Network user groups page.

When automatic activation is disabled in the Network user groups page, you can manually start/stop your Standard data profile from the Dashboard by clicking **Start <name of profile>** or **Stop <name of profile>** under **PROFILES ON LAN** at the bottom of the page.

Note

If another primary profile is active you must stop it before you can start your new profile.

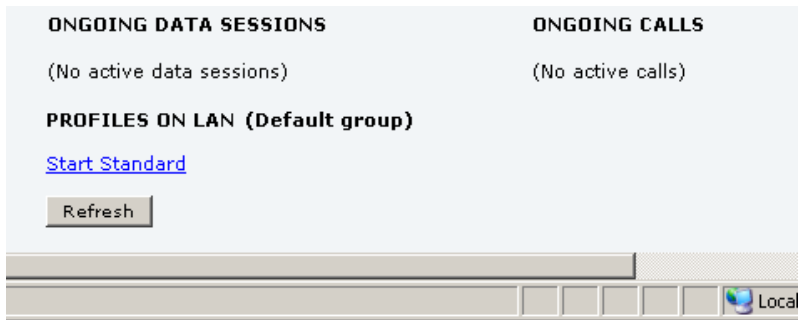

If a primary profile is already active, your new profile will not appear as a link but as plain text. The active primary profile is displayed as a link with the text “Stop <name of profile>”. Click this link first to stop the active profile. Then click your new profile, which is now displayed as a link.

Viewing information on calls and data sessions

The following sections in the **Dashboard** show information on calls and data sessions.

- **ONGOING CALLS** is a list of calls that are currently active. The list shows the call type and the time connected for each call.
- **ONGOING DATA SESSIONS** is a list of data profiles that are currently active, including the IP address that is assigned to each profile.
- **SESSIONS TOTAL** lists the totals for each connection. The list shows the time connected for voice and Streaming data, and MB transferred for Standard data.

The counters show totals for connections since the counters were last cleared.

The screenshot displays a dashboard with three main sections: PROPERTIES, ONGOING DATA SESSIONS, and STREAMING PROFILES ON LAN. The PROPERTIES section lists various device and network details. The ONGOING DATA SESSIONS and ONGOING CALLS sections both show '(No active data sessions)' and '(No active calls)' respectively. The STREAMING PROFILES ON LAN section shows '(No streaming profiles defined)'. A Refresh button is located at the bottom left of the dashboard area.

PROPERTIES		SESSIONS TOTAL	
Airtime provider	Thrane & Thrane	Standard voice inbound	00:19:08
GPS position	Acquiring	Standard voice outbound	00:11:35
Status	Scanning	3.1 kHz audio inbound	09:30:00
Satellite selection	Auto	3.1 kHz audio outbound	00:16:00
Unit serial number	05744519	Standard data	8.00 MB
Software version	01.01	Streaming 32 kbps	00:00:00
Local IP address	192.168.0.1	Streaming 64 kbps	00:00:00
IMEI number	35871200-000019-8	Streaming 128 kbps	19:08:00
MAC address	00:11:CF:01:12:B4	Streaming 256 kbps	00:00:00
Antenna	FBB55 (Sky scan)		

ONGOING DATA SESSIONS (No active data sessions)

ONGOING CALLS (No active calls)

STREAMING PROFILES ON LAN (No streaming profiles defined)

Refresh

Using the phone book

General usage

Overview

In the phone book you can:

- Look up phone numbers.
- Look up short dial numbers for easy dialing from a handset.
- Modify or delete existing names and phone numbers, or enter new names and phone numbers.

Accessing the phone book

To access the phone book, select **PHONE BOOK** from the left navigation pane.



The phone book shows all entries with entry number, name and phone number. Empty place holders are also included.

To sort the phone book, click the title of the column you wish to sort by. For example, to sort by the names in the phone book alphabetically, click on **Name** in the top row of the phone book.

The phone book holds 199 entries divided into subpages. To select the subpages you want, click the relevant link at the bottom of the page.

Short dial

The entry number in the phone book is the Short dial number. When making a call from the terminal you can use this number instead of dialing the entire phone number.

Simply dial **00 <short dial>** followed by **#** or off-hook key.

Example: To call the third entry in the phone book from an analog phone, take the phone off hook and dial **003 #**.

Editing phone book entries

Adding a new entry

To add a new entry, do as follows:

1. In the phone book, locate the empty entry number where you want to add the new phone number and click **New**.
2. Type in the name and phone number of the new entry and click **Save entry**.
The new name and number are now listed at the specified entry number in the phone book.

Modifying an entry in the phone book

To modify an entry, do as follows:

1. In the phone book, click **Edit** next to the entry you want to modify.
2. Modify the name or number as wanted and click **Save entry**.
The name and/or number in the selected entry is now replaced with the new information.

Deleting an entry in the phone book

To delete an entry, click **Delete** next to the entry you want to delete.

Deleting all entries in the phone book

To delete all the entries in the phone book, click **Delete all entries in phone book** at the bottom of the **PHONE BOOK** page.

Viewing and editing the mobile numbers

To view the mobile numbers

To view the mobile numbers of the terminal, select **PHONE BOOK > Mobile numbers** from the left navigation pane. The mobile numbers are the phone numbers to use when making a call to the terminal.

Note

These numbers are not listed at delivery. The user must enter the numbers received from the Airtime Provider.

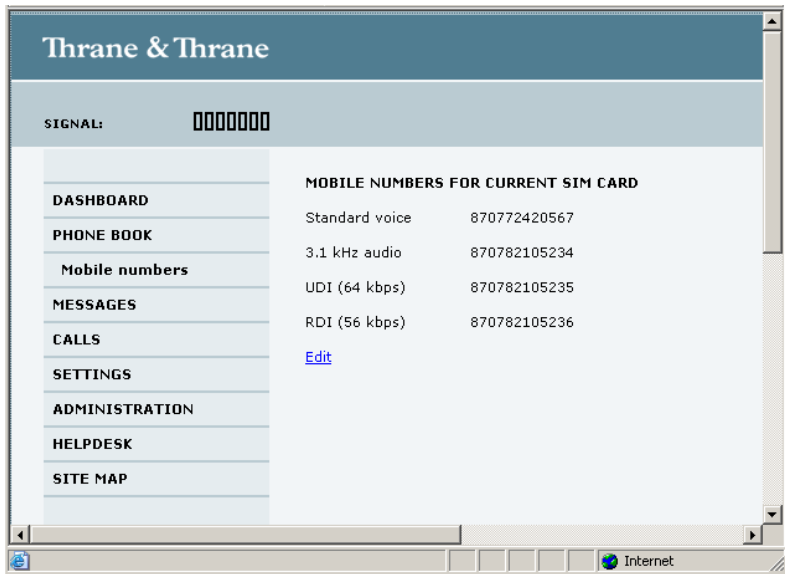

To enter or edit the mobile numbers

To enter or edit the mobile numbers, click **Edit** at the bottom of the page, type in the numbers received from your Airtime Provider and click **OK**.

Using the Call log

Note

If power to the terminal is interrupted, all information on calls since last power up is lost. This could mean that you will be charged for more calls than registered in the call log.

Information on total usage

To enter the CALLS page select **CALLS** from the left navigation pane. The CALLS page contains information on usage for circuit switched connections.

For an explanation of the circuit switched services, see *Circuit switched (dialed) service* on page 15.

The listed information includes:

- Time connected using Standard Voice and
- time connected using 3.1 kHz Audio.



Exporting the call log

The system logs all calls and data sessions. For information on how to view the lists of calls and data sessions, see the next section.

To export the entire call log to a file, do as follows:

1. In the **CALLS** page, click the link **Export call log to file**.
2. Browse to the location where you want to save the log.
3. Click **OK**.

Viewing the lists of calls

To see information on outgoing, received or missed calls or data sessions, select one of the following lists from the left navigation pane in the **CALLS** page:

- **Outgoing calls** shows the start time, receiving end phone number, duration, type (Standard or 3.1 kHz Audio) and estimated charge of each outgoing call.
- **Received calls** shows the start time, calling phone number, duration and type (Standard or 3.1 kHz Audio) of each incoming call.
- **Missed calls** shows the start time, calling phone number and type (Standard or 3.1 kHz Audio) of each incoming call that was not received.
- **Standard data sessions** shows the start time, bytes in, bytes out and estimated charge of each Standard data session.
- **Streaming data sessions** shows the start time, duration, type (Streaming 32, 64, 128 or 256 kbps) and estimated charge of each Streaming data session.

Date and time is UTC time, received from the satellite.

For information on the available types of service, see *The BGAN services* on page 14.

Note

The estimated charge is based on your entries under **ADMINISTRATION > Call charges**. Thrane & Thrane does not take responsibility for the correctness of this estimated charge.

You can sort each of the lists by clicking the title of the column you wish to sort by.

If a list covers more than one page, you can click the relevant link at the bottom of the page, to go to another page.

When there are more than 100 calls in the total list, the oldest calls are automatically removed to make room for new calls.

Handling SMS messages

Sending an SMS message

Important

If the terminal is not online when you attempt to send a message, the message is moved to the Outbox instead of the Sent folder. Messages in the Outbox are **not** automatically sent when the terminal goes online. For further information on the Outbox, see the next section, *Options for messages in the Outbox*.

To make sure a message has been sent, check that it has been moved to the Sent folder.

To send an SMS message **from** the terminal, do as follows:

1. Click **MESSAGES** from the left navigation pane. This page contains new incoming messages.
2. In the left navigation pane, click **Write message**.

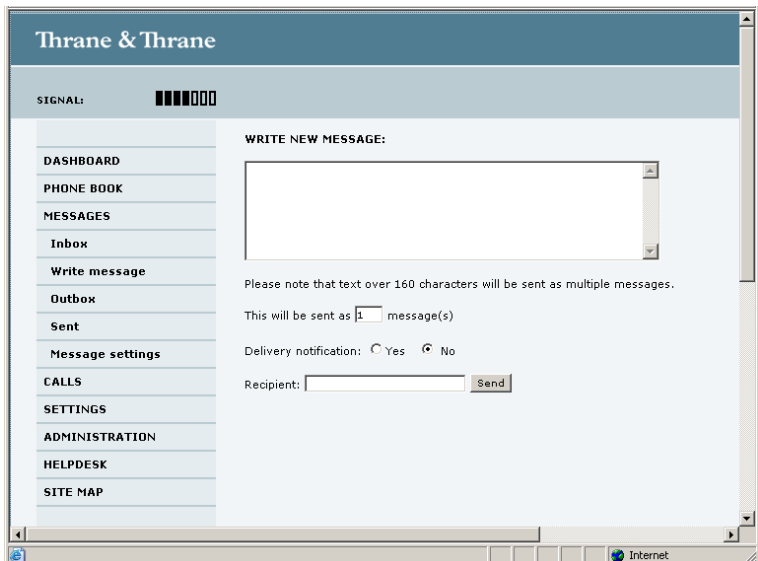

3. Type in the message in the **Write new message** field.
If the message text is too long for one SMS, the message is sent as two or more SMS messages. The field below the message field shows the number of SMS messages used to send the message.
4. Type in the phone number in the **Recipient** field.
Remember **00** and **country code** (e.g. **00 45** to call Denmark or **00 1** to call USA).
5. Select whether or not you want **Delivery notification** for this SMS message.
If you click Yes, the Status column in the Sent folder will show the status of your message when it has been sent.
You can set up delivery notification generally for all SMS messages. This setting is used by default when you send a message. For further information, see *Configuring message settings* on page 84.
6. Click **Send**.
The message is now sent and moved to the Sent folder.

Options for messages in the Outbox

Messages in the Outbox are messages that have not been sent, e.g. because the terminal was not online when you attempted to send the messages.

To access the Outbox, click **MESSAGES > Outbox** from the navigation pane.

You have the following options for messages in the Outbox:

- When the terminal is online, click **Resend** next to the message you want to send. When the **Write message** page opens, click **Send**.
The terminal now attempts to send the message again. To make sure the message has been sent, look in the Sent folder.

Note

The original message remains in the Outbox. When you have succeeded in sending the message you may want to delete it from the Outbox.

- Click **Delete** next to a message to delete it.
- Click **Delete all messages in Outbox** to delete all the messages.

Options for messages in the Sent folder

The Sent folder contains SMS messages that have been sent.

To access the Sent folder, select **MESSAGES > Sent** from the navigation pane.

The Status column shows the status of each message, if you have selected Delivery notification when sending the message.

From the Sent folder you have the following options:

- Click **Resend** next to a message you want to send again.
When the Write message page opens, click **Send**.
The terminal now attempts to send the message again. To make sure the message has been sent, look in the Sent folder. There should now be two copies of the sent message.
- Click **Forward** next to a message you want to forward.
Type in the phone number of the new recipient and click **Send**.
The terminal now attempts to send the message to the new recipient. To make sure the message has been sent, look in the Sent folder.
- Click **Delete** next to a message to delete it.
- Click **Delete all sent messages** to delete all the messages.

Sending an SMS message to the terminal

You can send an SMS message to the terminal e.g. from a mobile phone, using one of the mobile numbers for voice. Dial

+ <**Mobile number**>

The first part of the mobile number is always 870, which is the “country code” for the BGAN system. If the mobile numbers are listed in the web interface, you can look them up as follows:

Select **PHONE BOOK > Mobile numbers**. If the mobile numbers are not listed in the web interface, refer to your airtime subscription.

Note

There are two Voice numbers, one for 3.1 kHz Audio and one for Standard Voice.

Receiving a message

If a message has arrived, the icon bar at the top of the web interface shows an unopened envelope. Click the envelope to see the new message(s).

Otherwise, to see new messages click **MESSAGES** from the left navigation pane.

The page shows new incoming messages.

Note

The terminal does not accept more than 100 incoming messages (including read and unread messages). If you have received 100 messages, you have to delete some of them in order to free space for new messages. Otherwise, the new messages are rejected.

If the message is not an SMS message but information of voice mail, call your voice mail service number to hear the voice mail.

To find your voice mail number, select **MESSAGES > Message settings** from the left navigation pane and locate the **Voice mail number**.

Note that the voice mail number is only shown if it is available on the SIM card. Otherwise, refer to the information included with your Airtime subscription.

Options for new SMS messages

To see new messages, click **MESSAGES** from the left navigation pane.

Besides viewing the new messages, you have a number of options for what to do with each message:

- Click **Read** to move it to your Inbox containing read messages.
- Click **Reply** to reply to a message.
Then type in your reply and click **Send**.
For information on how to include the original message in your reply, see *Setting up the default message options* on page 84.
- Click **Forward** to forward a message to someone.
Then type in the phone number in the **Recipient** field and click **Send**.
- If you want to move all the new messages, click **Move all new messages to Inbox**.

Note

New messages cannot be deleted until they have been moved to the Inbox.

Options for SMS messages in the Inbox

The messages in the Inbox are the incoming messages that have been read and moved from the list of new messages (refer to the previous section).

From the Inbox, you have the following options:

- Click **Reply** to reply to a message.
Then type in your reply and click **Send**.
For information on how to include the original message in your reply, see *Setting up the default message options* on page 84.
- Click **Forward** to forward a message to someone.
Then type in the phone number in the **Recipient** field and click **Send**.
- Click **Delete** to delete the message.
- Click **Delete all messages in Inbox** to delete all read messages in the Inbox.

Configuring message settings

Setting up the default message options

You can set up general options for your outgoing messages. These settings apply by default to all your outgoing messages. Note, however, that you can change the Delivery notification setting for an individual message. For further information, see *Sending an SMS message* on page 79.

Do as follows:

1. Select **MESSAGES > Message settings** from the left navigation pane.



2. If you want to include the original message when you reply, select **Yes** next to **Include message in reply**.
3. Select whether or not you want **Delivery notification** for SMS messages. If you click Yes, the Status column in the Sent folder will show the status of your message when it has been sent.
4. Click **Apply**.

Viewing or changing SMS service center number

The SMS service center number identifies the SMS service center used when sending and receiving SMS messages. The SMS service center number is stored on the SIM card.

- To see the SMS service center number, select **MESSAGES > Message settings** from the left navigation pane.
- To change the number, click **Edit** next to **SMS service center**, change the number and click **Save**. Then click **Apply** to apply all changes in the page.

The SMS service center number is provided from your Airtime Provider.

Viewing the Voice mail number

The Voice mail number is the number you call to hear your incoming voice mails.

Note

The Voice mail number is only listed if it is available on the SIM card. Otherwise, refer to the information included with your Airtime subscription.

To see the Voice mail number, select **MESSAGES > Message settings** from the left navigation pane. The **Voice mail number** field shows the Voice mail number.

Setting up the interfaces

The SETTINGS page (Antenna properties)

The **SETTINGS** page shows properties of the connected antenna and contains a field for enabling or disabling the L-Band interface on the terminal.

To access the **SETTINGS** page, select **SETTINGS** from the left navigation pane.

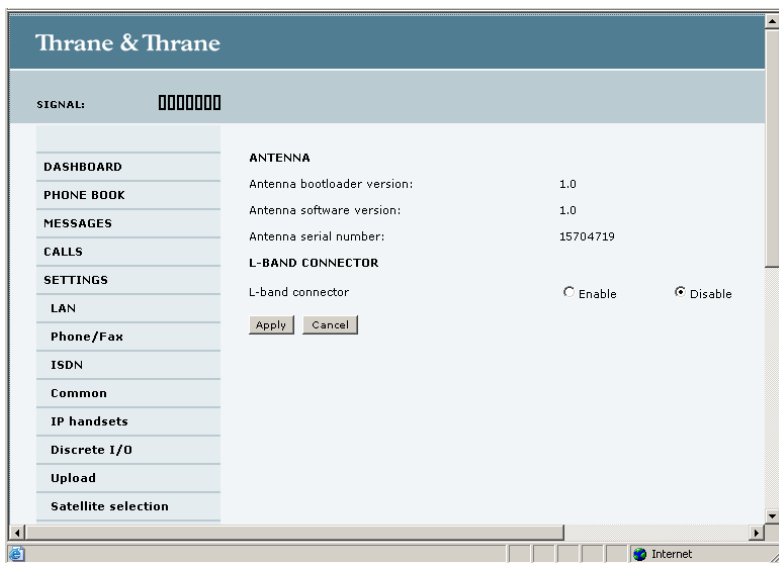

Enabling or disabling the L-Band interface

The L-Band interface is used for connecting a broadband receiver for reception of position data. To enable or disable the L-Band interface, do as follows:

1. In the **L-BAND CONNECTOR** field of the **SETTINGS** page, select **Enable** or **Disable**.
2. Click **Apply**.

Configuring the LAN interface

Overview

The SAILOR FleetBroadband terminal has 4 LAN connectors with PoE (Power over Ethernet).

The major part of the LAN parameters are set up in the network management pages. For information on these settings, refer to *Managing LAN network users* on page 111.

**Caution!**

All connections to the LAN interface may be affected when you change the settings below. This also includes your own current connection.

Setting up the LAN interface

Do as follows:

1. From the left navigation pane, select **SETTINGS > LAN**.

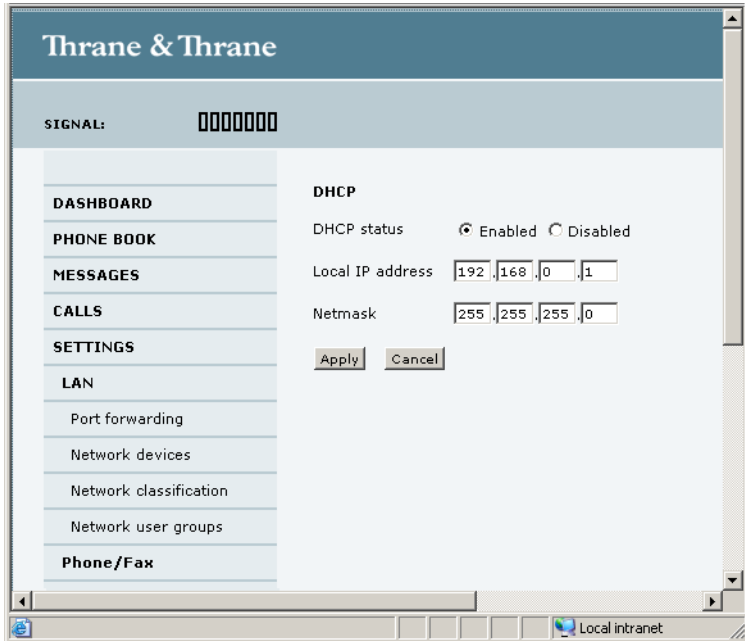

2. At **DHCP status**, select **Enabled** (recommended), or **Disabled**.
 - If you select **Enabled**, the terminal assigns dynamic IP addresses to devices connected to the terminal.
 - If you select **Disabled**, you need to set up a static IP address in the connected device.
3. Type in the **Local IP address** and the **Netmask**.

The Local IP address is the IP address used for accessing the web interface.
4. Click **Apply**.

Port forwarding

Port forwarding enables you to set up a server connected to the terminal while the terminal is in Router mode. Without port forwarding it would not be possible to contact the server from the internet.

For information on how to set the terminal in Router mode, see *Setting up the network user groups* on page 113.

The following example shows how to allow internet access to a mail server (smtp) connected to the terminal.

The mail server in this example has the IP address 192.168.0.100.

1. Select **LAN > Port forwarding** in the left navigation pane.

Thrane & Thrane

SIGNAL: 000000

PORT FORWARDING

Port forwarding Enabled Disabled

Active	Incoming port range	Destination IP	Destination port range
<input checked="" type="checkbox"/>	25 - 25	192.168.0.100	25 - 25
<input type="checkbox"/>	0 - 0	0.0.0.0	0 - 0
<input type="checkbox"/>	0 - 0	0.0.0.0	0 - 0
<input type="checkbox"/>	0 - 0	0.0.0.0	0 - 0
<input type="checkbox"/>	0 - 0	0.0.0.0	0 - 0
<input type="checkbox"/>	0 - 0	0.0.0.0	0 - 0
<input type="checkbox"/>	0 - 0	0.0.0.0	0 - 0
<input type="checkbox"/>	0 - 0	0.0.0.0	0 - 0
<input type="checkbox"/>	0 - 0	0.0.0.0	0 - 0
<input type="checkbox"/>	0 - 0	0.0.0.0	0 - 0
<input type="checkbox"/>	0 - 0	0.0.0.0	0 - 0

Apply Cancel

Satellite selection

2. Select **Enabled** to generally enable port forwarding.
3. Type in the **Incoming port range**.
4. Type in the **Destination IP** address, which in this example is the IP address of the mail server: 192.168.0.100.

5. Type in the **Destination port range**.
6. Repeat step 3 to step 5 to set up port forwarding to additional servers.
7. In the **Active** column, select which ports should have port forwarding activated.
8. Click **Apply**.

You can now access the mail server from the Internet, using the external IP address of the terminal.

Configuring the Phone/Fax interface

Do as follows:

1. Select **SETTINGS > Phone/Fax** from the left navigation pane.



2. For each Phone/Fax port, set the call type for incoming and outgoing calls.

Note

Port 1 is the connector closest to the antenna connector, and Port 2 is the connector closest to the ISDN connector.

The call types are described in more detail in *Selecting the call type* on page 39.

- For **Incoming calls**, you can check Standard or 3.1 kHz Audio or both. If you check both, any device connected to the Phone/Fax interface will react (ring) on incoming calls. If you select e.g. Standard, the Phone/Fax interface will only react on calls made to the Standard phone number.
- For **Outgoing calls**, you can select either Standard or 3.1 kHz Audio. The selected type will be used by default, if possible, for any outgoing call. Note, however, that fax machines and modems must use 3.1 kHz Audio.

Note

You can override the default setting for outgoing calls by dialing 1* (force the call to Standard) or 2* (force the call to 3.1 kHz Audio) before the number. For further information, see *Overriding the default outgoing call type* on page 40.

3. Click **Apply**.

Configuring the ISDN interface

Note

For information on how to set up call services (supplementary services), see *Setting up call services* on page 97. These settings apply to both the Phone/Fax interface, the ISDN interface and the LAN w. PoE interface.

To configure the ISDN interface, do as follows:

1. Select **SETTINGS > ISDN**.

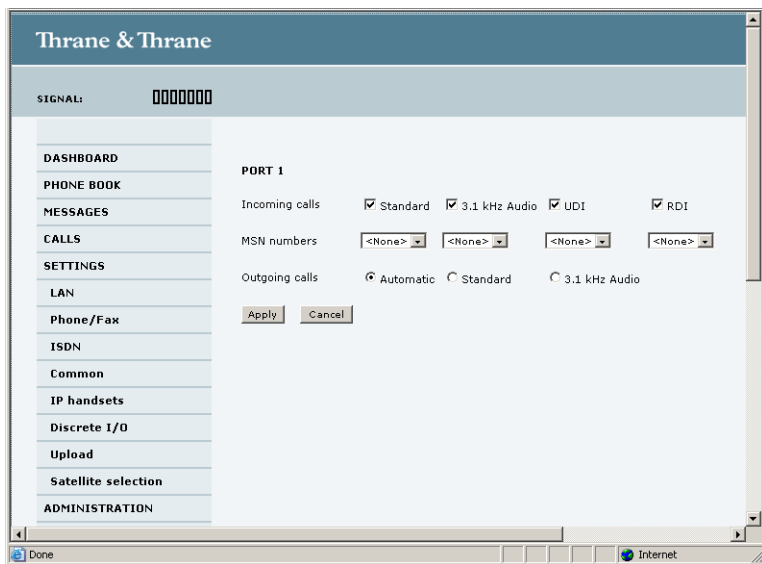

2. Set the call type(s) for incoming calls.

You can select Standard, 3.1 kHz Audio, UDI and/or RDI. Note that for SAILOR 250 FleetBroadband you can only select Standard or 3.1 kHz Audio.

Note

Connected devices will only receive incoming calls with the call types that are selected here.

For example, if only Standard is selected, and a G4 fax call (using call type UDI) arrives, a fax connected to the ISDN port will not receive the incoming call.

3. Set the MSN numbers that are to be assigned to each call type.

Note that this setting only applies to the call type selected above the MSN number, and only if the connected device supports the call type used.

Important

If you set an MSN number to anything other than <None>, connected devices must be programmed with these MSN numbers.

You have the following options with the MSN numbers:

- **<None>**. No MSN numbers are used. An incoming call is accepted in all devices connected to this port.
- **1*, 2*, 3* or 4***: If, for example, you select 1* at Standard call type, an incoming Standard call is accepted by all devices that are programmed with the number 1* and connected to the ISDN interface.
- **0401, 0402**: These are local numbers for separate devices connected to the ISDN interface.
An incoming call is accepted by devices that are programmed with the selected number and connected to the ISDN interface.

You can combine the MSN settings.

Example: You have two devices connected to the ISDN interface. One is programmed with the numbers 1* and 0401, the other is programmed with 1* and 0402.

In the web interface, you select the MSN number 1* under Standard.

If an incoming Standard call arrives, both devices will accept the call.

If you make a local call to one of the local numbers 0401 or 0402, only the called device will accept the call.

4. Set the call type for outgoing calls.

- If you select **Automatic**, the call type will be determined by the calling device.
- If you select **Standard**, all outgoing calls, except UDI/RDI, will use the call type Standard. If you make a 3.1 kHz Audio call it will be converted to a Standard call.
Outgoing UDI or RDI sessions will not be influenced by this setting.

- If you select **3.1 kHz Audio**, all outgoing calls, except UDI/RDI, will use the call type 3.1 kHz Audio. If you make a Standard call it will be converted to a 3.1 kHz Audio call. Outgoing UDI or RDI sessions will be not be influenced by this setting.

Note

You can override the call type setting for outgoing calls by dialing one of the following prefixes before the number:

- 1* (force the call to Standard)
- 2* (force the call to 3.1 kHz Audio)

Refer to *Overriding the default outgoing call type* on page 40.

5. Click **Apply**.

Setting the common interface settings

The common APN

The common APN setting is defined here and can be selected for each network user group. If you are using the same APN for many network user groups, it is easier to define it once, and then simply select it for the relevant user groups. Also, if you change the common APN at a later stage, it is automatically updated for all network user groups where the Common setting is selected.

To set up the common interface settings

Do as follows:

1. Select **SETTINGS > Common**.



2. Select the **APN**. You have the following options:
 - **SIM default**. The APN is taken from the SIM card. This is the recommended option, unless you have special requirements.
 - **Network assigned**. The APN is assigned from the network.
 - **User defined**. Type in the APN. APNs are provided from the Airtime Provider.
3. At **Buffering on Streaming profiles**, select **Enabled** or **Disabled**.
 - If you select **Enabled**, your Streaming connection will be buffered. This means that the transmission is slightly delayed in order to ensure a precise and continuous data stream.
 - If you select **Disabled**, your Streaming connection will not be buffered. This means the data is delivered immediately, but may vary slightly in transmission speed.
4. Click **Apply**.

How to use the common APN

When you configure the APN for your individual network user group, select **Common** to use the setting from this page.

Where Common is selected in the individual groups, the setting will automatically be updated when the Common APN is changed.

Setting up call services

Overview

Note

The terminal must be registered on the BGAN network before you can set up the call services in the web interface.

In the web interface you can set up the following supplementary services:

- Call forwarding
- Call barring
- Call waiting
- Line identification
- Closed user group

Note that, depending on the network, some of these call service settings may prevent others from being activated.

The settings apply for all connected devices using a circuit-switched service.

Call forwarding

You can set up the terminal to automatically forward incoming calls to another phone number. Do as follows:

1. Select **SETTINGS > Common > Call forward** from the left navigation pane.

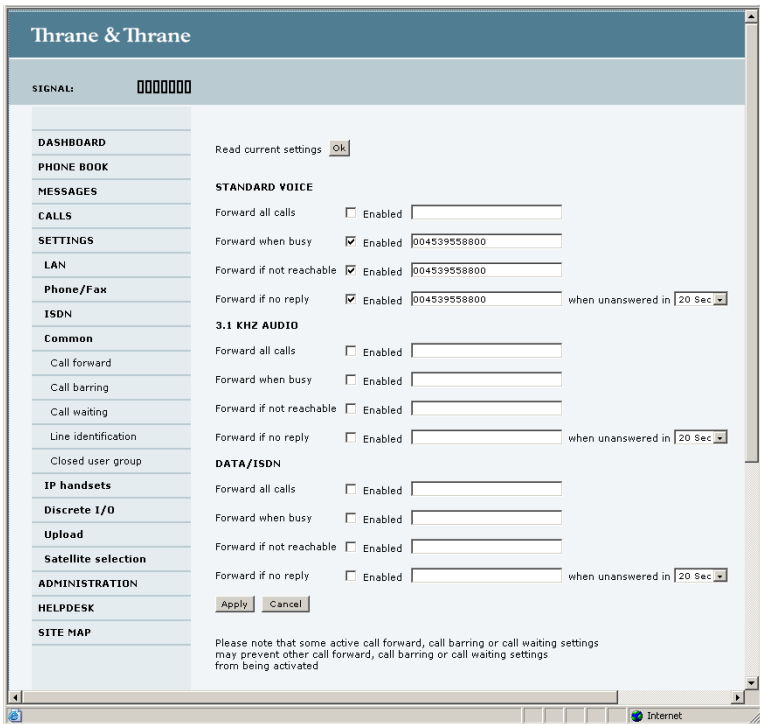

2. For each call type, select **Enabled** next to the situation(s) in which you want to forward incoming calls.
3. Next to the enabled items, type in the phone number you want to forward the call to.
4. If you have selected **Forward if no reply**, select from the drop-down list the period of time the system should wait before forwarding the call.
5. Click **Apply**.

Call barring

Do as follows to bar incoming and/or outgoing calls to and from the terminal:

1. Select **SETTINGS > Common > Call barring** from the left navigation pane.

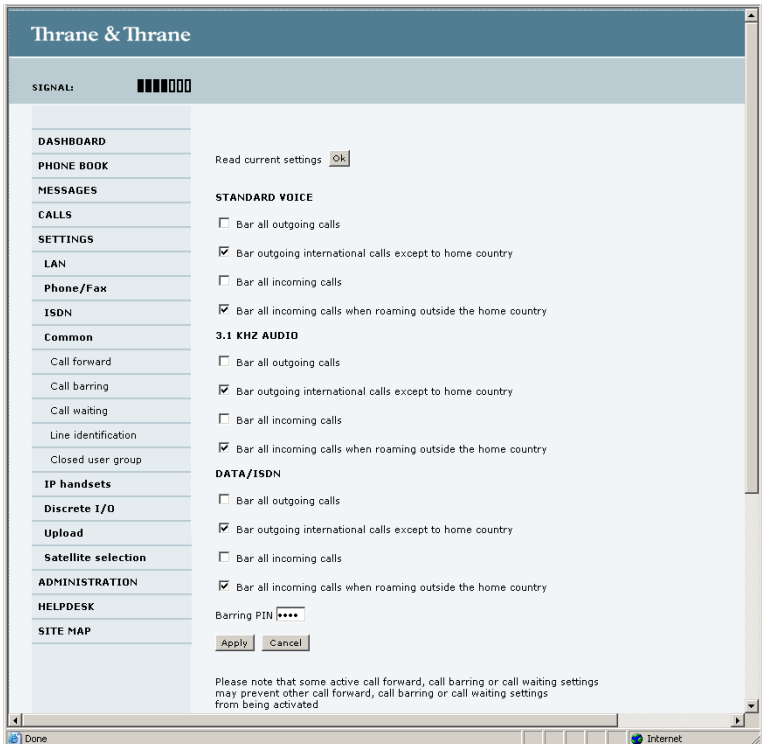

2. Click **OK** next to **Read current settings**, to make sure the page is updated.
3. For each call type, select which calls should be barred.
4. In the **Barring PIN** field, type in a PIN for your call barring setup.

Note

This is **not** the SIM PIN entered at startup, but a network PIN which is supplied together with your SIM PIN.

5. Click **Apply**.

Call waiting

You can set up whether or not you want to receive notification of waiting calls while you are making a call or transmitting data.

Do as follows:

1. Select **SETTINGS > Common > Call waiting** from the left navigation pane.

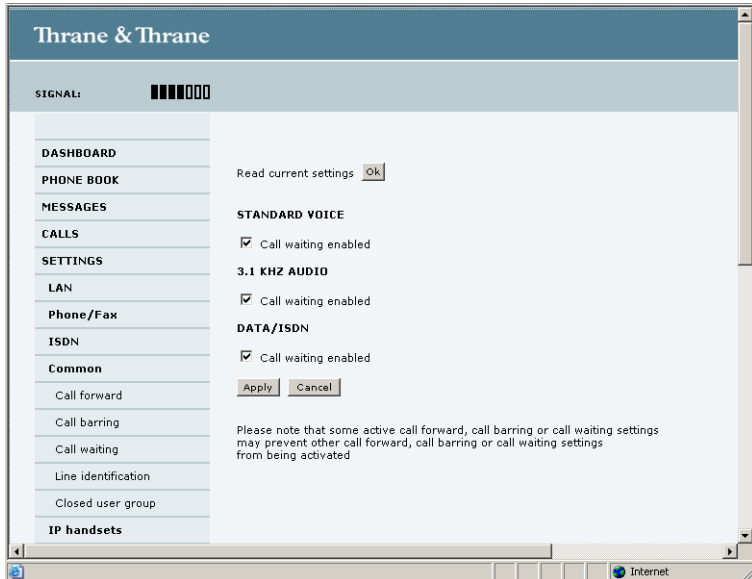

2. Click **OK** next to **Read current settings** to make sure the page is updated.
3. For each call type, select **Call waiting enabled** if you want to get notification of waiting calls while you are making a call or transmitting data.
4. Click **Apply**.

Line identification

You can set up the terminal to show your number when you are making a call or transmitting data.

Do as follows:

1. Select **SETTINGS > Common > Line identification** from the left navigation pane.

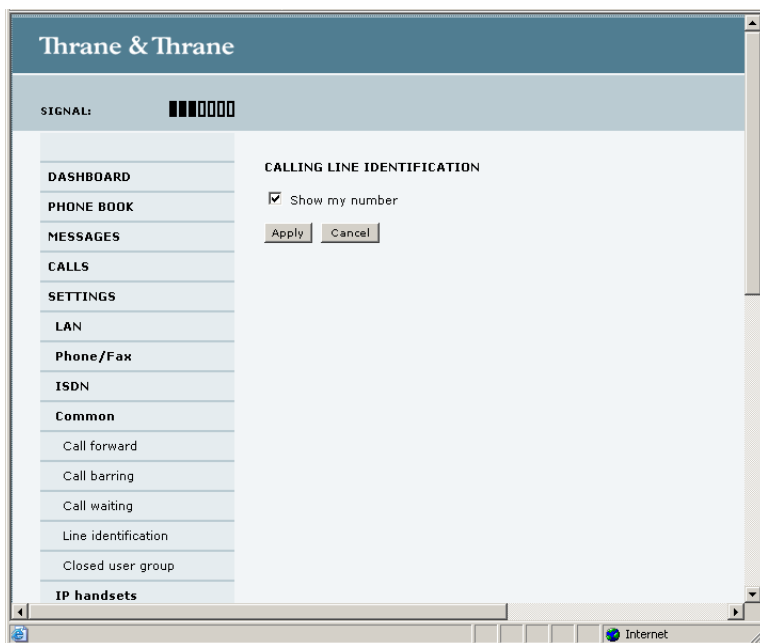

2. Select **Show my number** and click **Apply**.

Closed user group

Your subscription may include one or more closed user groups. A closed user group is a group of users permitted to make calls to each other but not to users outside the group.

To define the settings for these user groups, do as follows:

1. Select **SETTINGS > Common > Closed user group** from the left navigation pane.

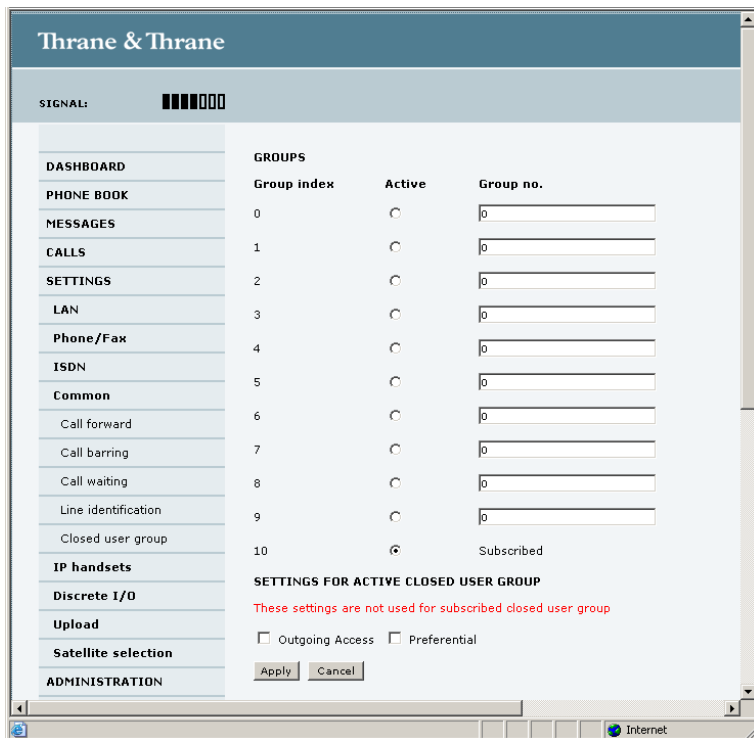

2. Type in your user group number(s) under **Group no.**
3. Select which group(s) should be active.
If you select **Subscribed**, the group(s) included in your subscription will be active.

4. To allow outgoing access for the activated user group(s), select **Outgoing Access** under **SETTINGS FOR ACTIVE CLOSED USER GROUP**. Note that if you selected **Subscribed** above, this setting will not be used.
5. Select **Preferential** if you want the activated user group to be selected when a member of a user group does not specify the group number during call set up. Note that if you selected **Subscribed** above, this setting will not be used.
6. Click **Apply**.

Managing IP handsets

Overview

The terminal has 4 LAN (PoE) connectors for connection of IP handsets or other IP equipment. You may connect your IP handsets directly to the LAN interfaces or use a PoE switch to connect more handsets. The SAILOR FleetBroadband terminal supports connection of up to 16 handsets.

Each handset must have a local number in the range 0501 to 0516 as well as a unique password.

Connecting a new IP handset

Note

The first handset that is connected to the LAN interface on the terminal is automatically registered in the terminal and assigned the local number 0501 and password 0501.

To connect a new IP handset, do as follows:

1. Connect the IP handset to one of the LAN ports of the terminal.
2. In the web interface, select **SETTINGS > IP handset**.



The screenshot shows the Thrane & Thrane web interface. At the top, there is a header 'Thrane & Thrane' and a signal strength indicator. Below the header is a table with columns: Entry, Number, Handset password, Actions, and Configure handset. The table lists 16 entries, each with a 'New' link in the Actions column and a 'Not active' status in the Configure handset column. The 'IP handsets' section is highlighted in blue.

	Entry	Number	Handset password	Actions	Configure handset
DASHBOARD	1	0501	0501	Edit/Delete	Configure
PHONE BOOK	2	0502		New	Not active
MESSAGES	3	0503		New	Not active
CALLS	4	0504		New	Not active
SETTINGS	5	0505		New	Not active
LAN	6	0506		New	Not active
Phone/Fax	7	0507		New	Not active
ISDN	8	0508		New	Not active
Common	9	0509		New	Not active
IP handsets	10	0510		New	Not active
Call settings	11	0511		New	Not active
Discrete I/O	12	0512		New	Not active
Upload	13	0513		New	Not active
Satellite selection	14	0514		New	Not active
ADMINISTRATION	15	0515		New	Not active
HELPDESK	16	0516		New	Not active
SITE MAP					

3. Next to the local number you wish to use, click **New**.
4. Enter the password you want for your IP handset.

5. In the IP handset, use the display menu system to enter the local number and the password you just entered in the web interface. Do as follows:
 - Enter the menu system and select **SIP** to get the list of profiles.
 - Select the **BGAN** profile and select **Options**.
 - Select **Edit/View** and change the user name and password. Note that the user name is also the local number for the handset.

When the terminal and the handset have recognized each other, a **Configure** link appears next to the handset in the **IP handsets** page of the web interface. This link provides direct access to the built-in web interface of the IP handset. For further information, refer to the user manual for the IP handset.

Setting up the IP handsets

Do as follows:

1. Select **SETTINGS > IP handset**.

Thrane & Thrane					
SIGNAL: 0000000					
	Entry	Number	Handset password	Actions	Configure handset
DASHBOARD	1	0501	0501	Edit/Delete	Configure
PHONE BOOK	2	0502		New	Not active
MESSAGES	3	0503		New	Not active
CALLS	4	0504		New	Not active
SETTINGS	5	0505		New	Not active
LAN	6	0506		New	Not active
Phone/Fax	7	0507		New	Not active
ISDN	8	0508		New	Not active
Common	9	0509		New	Not active
IP handsets	10	0510		New	Not active
Call settings	11	0511		New	Not active
Discrete I/O	12	0512		New	Not active
Upload	13	0513		New	Not active
Satellite selection	14	0514		New	Not active
ADMINISTRATION	15	0515		New	Not active
HELPDESK	16	0516		New	Not active
SITE MAP					

2. Select **Edit** next to a handset to change the password of the handset.
Remember that you must enter the same password as well as the local number (user name) in the IP handset.
3. Select **Delete** next to a handset to delete it from the list.
When a handset is deleted from the list, you can no longer access the terminal with this handset.
4. Select **Configure** next to a handset to enter the built-in web interface of the IP handset.

With the web interface of the IP handset you can access the internal settings of the IP handset. For further information, refer to the user manual for the IP handset.

Setting the call types for IP handsets

Do as follows:

1. Select **SETTINGS > IP handsets > Call settings**.

	Number	Incoming calls		Outgoing calls	
DASHBOARD	0501	<input checked="" type="checkbox"/> Standard	<input checked="" type="checkbox"/> 3.1 kHz Audio	<input checked="" type="radio"/> Standard	<input type="radio"/> 3.1 kHz Audio
PHONE BOOK	0502	<input checked="" type="checkbox"/> Standard	<input checked="" type="checkbox"/> 3.1 kHz Audio	<input checked="" type="radio"/> Standard	<input type="radio"/> 3.1 kHz Audio
MESSAGES	0503	<input checked="" type="checkbox"/> Standard	<input checked="" type="checkbox"/> 3.1 kHz Audio	<input checked="" type="radio"/> Standard	<input type="radio"/> 3.1 kHz Audio
CALLS	0504	<input checked="" type="checkbox"/> Standard	<input checked="" type="checkbox"/> 3.1 kHz Audio	<input checked="" type="radio"/> Standard	<input type="radio"/> 3.1 kHz Audio
SETTINGS	0505	<input checked="" type="checkbox"/> Standard	<input checked="" type="checkbox"/> 3.1 kHz Audio	<input checked="" type="radio"/> Standard	<input type="radio"/> 3.1 kHz Audio
LAN	0506	<input checked="" type="checkbox"/> Standard	<input checked="" type="checkbox"/> 3.1 kHz Audio	<input checked="" type="radio"/> Standard	<input type="radio"/> 3.1 kHz Audio
Phone/Fax	0507	<input checked="" type="checkbox"/> Standard	<input checked="" type="checkbox"/> 3.1 kHz Audio	<input checked="" type="radio"/> Standard	<input type="radio"/> 3.1 kHz Audio
ISDN	0508	<input checked="" type="checkbox"/> Standard	<input checked="" type="checkbox"/> 3.1 kHz Audio	<input checked="" type="radio"/> Standard	<input type="radio"/> 3.1 kHz Audio
Common	0509	<input checked="" type="checkbox"/> Standard	<input checked="" type="checkbox"/> 3.1 kHz Audio	<input checked="" type="radio"/> Standard	<input type="radio"/> 3.1 kHz Audio
IP handsets	0510	<input checked="" type="checkbox"/> Standard	<input checked="" type="checkbox"/> 3.1 kHz Audio	<input checked="" type="radio"/> Standard	<input type="radio"/> 3.1 kHz Audio
Call settings	0511	<input checked="" type="checkbox"/> Standard	<input checked="" type="checkbox"/> 3.1 kHz Audio	<input checked="" type="radio"/> Standard	<input type="radio"/> 3.1 kHz Audio
Discrete I/O	0512	<input checked="" type="checkbox"/> Standard	<input checked="" type="checkbox"/> 3.1 kHz Audio	<input checked="" type="radio"/> Standard	<input type="radio"/> 3.1 kHz Audio
Upload	0513	<input checked="" type="checkbox"/> Standard	<input checked="" type="checkbox"/> 3.1 kHz Audio	<input checked="" type="radio"/> Standard	<input type="radio"/> 3.1 kHz Audio
Satellite selection	0514	<input checked="" type="checkbox"/> Standard	<input checked="" type="checkbox"/> 3.1 kHz Audio	<input checked="" type="radio"/> Standard	<input type="radio"/> 3.1 kHz Audio
ADMINISTRATION	0515	<input checked="" type="checkbox"/> Standard	<input checked="" type="checkbox"/> 3.1 kHz Audio	<input checked="" type="radio"/> Standard	<input type="radio"/> 3.1 kHz Audio
HELPDESK	0516	<input checked="" type="checkbox"/> Standard	<input checked="" type="checkbox"/> 3.1 kHz Audio	<input checked="" type="radio"/> Standard	<input type="radio"/> 3.1 kHz Audio
SITE MAP					

Apply Cancel

2. For each handset, select the call types you want to enable for incoming and outgoing calls.

The call types are described in more detail in *Selecting the call type* on page 39.

- For **Incoming calls**, you can check Standard or 3.1 kHz Audio or both. If you check both, the handset will react (ring) on any incoming call. If, for example, you select Standard, the handset will only react on calls made to the Standard phone number.
- For **Outgoing calls**, you can select either Standard or 3.1 kHz Audio. The selected type will be used by default, if possible, for any outgoing call.

3. Click **Apply**.

Configuring the discrete I/O interface

Overview

The I/O interface on the terminal has 5 configurable I/O pins. You can set up the function of each pin in the web interface. The default functions of the I/O pins are as follows:

- **Pin 1: Ringer output.**

This pin changes state from low to high when the terminal is notified of an incoming call from the satellite interface. When the call is answered, or the caller gives up and releases the call, the pin changes back to low.

- **Pin 2: Warning/Error output.**

This pin provides an external signal that indicates active warning/error condition(s). The signal stays active until all warnings/errors are cleared.

- **Pin 3: Mute output.**

The mute output pin provides an external signal that is active during a phone call. The signal can be used to mute external equipment, such as a car-radio.

- **Pin 4: Radio silence input.**

When active the terminal observes Radio Silence. The terminal gracefully closes all open connections, and deregisters from the BGAN network. No transmission is allowed until the pin is deactivated.

- **Pin 5/8: Ignition input.**

The ignition function uses pin 5 together with pin 8 (DC in). Connect the appropriate pin to the ignition key switch as follows:

If the input should be active high, connect pin 5 to Ground, and use pin 8 to switch on the terminal by pulling it high (10-32 V DC).

If the input should be active low, connect pin 8 to positive DC voltage, and use pin 5 to switch on the terminal by pulling it low (< 1.2 V DC).

Note

The Ignition function is normally not used in maritime installations. You may use the Remote on/off function in the power connector instead.

Configuring the I/O interface

To configure the I/O pins, do as follows:

1. Select **SETTINGS > Discrete I/O**.

The screenshot shows the 'Discrete I/O' configuration page in the Thrane & Thrane web interface. The page has a dark blue header with the company name and a light blue sidebar with navigation options. The main content area is white and contains the following sections:

- SIGNAL:** A signal strength indicator showing six bars.
- Navigation Menu:** DASHBOARD, PHONE BOOK, MESSAGES, CALLS, SETTINGS, LAN, Phone/Fax, ISDN, Common, IP handsets, Discrete I/O (selected), Upload, Satellite selection, ADMINISTRATION, HELPDESK, SITE MAP.
- DISCRETE I/O Table:**

Pin	I/O	Function	Enabled	Polarity
1	Output	Ringer	<input checked="" type="checkbox"/>	<input checked="" type="radio"/> Active high <input type="radio"/> Active low
2	Output	Warning	<input type="checkbox"/>	<input checked="" type="radio"/> Active high <input type="radio"/> Active low
3	Output	Mute	<input type="checkbox"/>	<input checked="" type="radio"/> Active high <input type="radio"/> Active low
4	Input	Radio silence	<input type="checkbox"/>	<input type="radio"/> Active high <input checked="" type="radio"/> Active low
5	Input	Ignition	<input type="checkbox"/>	<input type="radio"/> Active high <input checked="" type="radio"/> Active low
- DELAYED SHUTDOWN:** Delay: 0 (Minutes)
- RINGER OUTPUT:** Incoming calls: Standard 3.1 kHz Audio UDI RDI
- MUTE OUTPUT:** Incoming calls: Standard 3.1 kHz Audio UDI RDI
- Buttons:** Apply, Cancel

2. For each pin you want to use, select **Enabled**.
3. For each pin, select if the pin should be **Active high** or **Active low**.
4. If you are using the Ignition function and you want the terminal to stay on for a few minutes after the Ignition is switched off, enter the number of minutes under **DELAYED SHUTDOWN**.
For further information on the Ignition function, see *Using the ignition system* on page 22.
5. If you are using a ringer output, select the incoming call types that should activate the ringer under **RINGER OUTPUT**.
6. If you are using a Mute output, select the incoming call types that should activate the Mute function under **MUTE OUTPUT**.
7. Click **Apply**.

Managing LAN network users

Introduction

The network management system

The network management system divides the users of the SAILOR FleetBroadband terminal into network user groups. Each network user group has a profile which determines how the users connect to the Inmarsat BGAN network. The network user groups can allow or restrict certain services for different users.

For example, you may want to define:

- one network user group for Bridge communication, allowing both Standard and Streaming connections,
- one network user group for Crew welfare, allowing Standard connections,
- one network user group for IP handsets, allowing no Internet access.
- one network user group for Remote management of systems at the bridge or in the engine room. This would be a direct Standard connection (Bridge mode).

The SAILOR FleetBroadband terminal supports up to 11 different network user groups and global IP addresses.

Necessary steps when managing network users

The steps necessary for managing network users include:

1. **Defining a network user group.** See *Setting up the network user groups* on page 113.

The network user groups determine settings such as:

- QoS (Standard/Streaming),
- IP addressing (Static/Dynamic)
- Internet access mode (Router Mode/Bridge Mode/No Internet Access)

2. **Identifying a network device.** See *Managing network devices* on page 119.

The network devices are identified by their IP address, MAC address and (optionally) device name.

3. **Associating the network user group and the network device.** See *Using the network classification table* on page 121.

The network classification table determines which devices should belong to which network user group. When a network device is connected, the terminal runs through the network classification table to check if the new connection matches any of the entries in the table. When a match is found, the terminal establishes a PDP context and the device is ready for use with the terminal.

Access to the network management settings

Access to the network management settings requires an Administrator password.

The Administrator can create and manage network user groups and set up a network classification table defining priorities for devices, network groups and LAN ports.



Caution!

All user connections to the LAN interface may be affected when you change the settings below, including your own current connection.

Setting up the network user groups

Overview

A network user group, in this context, is a group of network users sharing the same Quality of Service profile and network parameters.

There are 11 configurable network user groups. For the Default user group, certain settings are locked, to make sure there is always one functional user group available. For example, the Default user group does not allow you to select a Bridge mode connection.

Note

The network user groups cannot be deleted. If you do not want to use them, click **Edit** and select **Disabled** at **Status** in the **NETWORK USER GROUP** field.

Editing a network user group

Note

For further explanation of the terms used below, see *Definitions for network terms* on page 124.

Do as follows:

1. Select **SETTINGS > Network user groups**.

When you are prompted, enter the Administrator user name and password. The default user name is **admin** and the default password is **1234**.

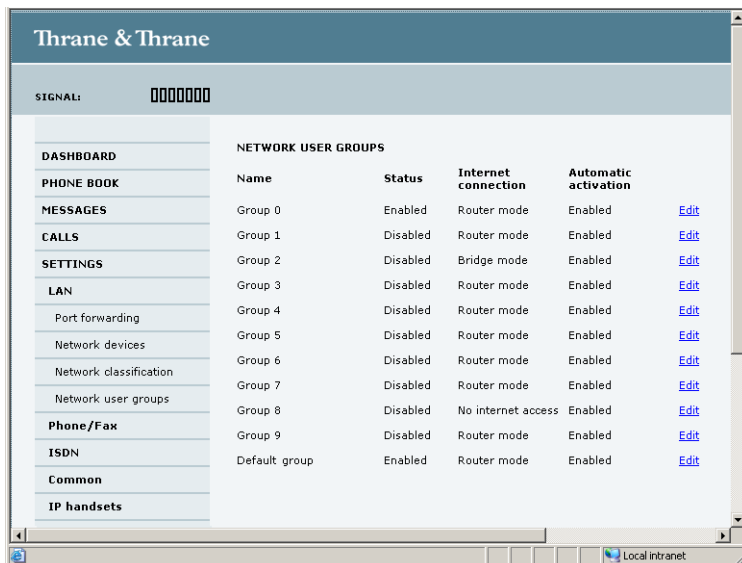

- Click **Edit** next to the user group you want to set up.

SIGNAL: 00000000

DASHBOARD

PHONE BOOK

MESSAGES

CALLS

SETTINGS

LAN

Port forwarding

Network devices

Network classification

Network user groups

Phone/Fax

ISDN

Common

IP handsets

Discrete I/O

Upload

Satellite selection

ADMINISTRATION

HELPDESK

SITE MAP

NETWORK USER GROUP

Name: Group 0

Status: Enabled Disabled

Internet connection: Router mode

Changes to Status and Internet connection only take effect after reboot

TCP/IP

Dynamic IP address

Static IP address

IP Header compression: Enabled Disabled

APN

Common

SIM default

Network assigned

User defined: bgan.inmarsat.com

User name:

Password:

PROFILES

Automatic activation: Enabled Disabled

Primary: Streaming 128

Secondary: Streaming 128

PROFILE CIDS

Profile	Cid
Streaming 128	1

Apply Cancel

- Type in a name for the group.
- Select **Enabled** or **Disabled**.

5. Select the type of **Internet connection**.

- **Router mode** means the connection will be shared with other users, and the NAT module of the terminal will make the necessary address translations. Use this mode if one or more computers are connected using the LAN interface, and the terminal should act as a router.
- **Bridge mode** is an exclusive connection, with NAT disabled. Use this mode together with a network classification entry that selects a single computer (see *Using the network classification table* on page 121). This mode is not available in the Default user group.
- **No internet access** means no connection to the Internet is allowed. Use this setting e.g. for IP handsets, where an Internet connection is not required. The external voice connection is still available; this setting only affects communication over the Internet.

6. Select **Dynamic IP address**.

This is the IP address used externally on the satellite network.

If you want to use a **static IP address**, and your subscription allows it, you must still leave this setting at **Dynamic**. Then select **SIM default** in step 8 and type in the APN user name and password from your provider in step 9. Your terminal will then use the static IP address set up for your SIM card.

Note

Typing in a static IP address is currently not supported by the BGAN network.

7. Set **IP Header compression** to **Enabled** or **Disabled**.

For information on IP Header compression, see *Header compression* on page 124.

8. Select the source of the **APN** (Access Point Name).

There are four options for setting the APN. Unless you have special requirements, it is recommended to use the SIM default, or to set the common APN to SIM default, and then select Common here. You have the following options:

- **Common**. The APN is taken from the Common APN defined under SETTINGS > Common. Refer to *Setting the common interface settings* on page 95.

- **SIM default.** The APN is taken from the SIM card. If you want to use a static IP address on the external network, select this option either here or in the Common setting.
 - **Network assigned.** The APN is assigned from the network.
 - **User defined.** Type in the APN. APNs are provided from the Airtime Provider.
9. If your APN uses a password, type in the user name and password provided from the Airtime Provider.

Note

If you are going to use the static IP address from your SIM card, the user name and password are mandatory! See step 6 above.

10. At **Automatic activation** select whether the profile selected in the next step should be activated automatically or manually.

Note

If the selected primary profile is a Streaming profile, this setting has no effect. Streaming profiles must always be activated manually from the Dashboard.

- **Disabled** means you can activate/deactivate the profile from the Dashboard.
 - **Enabled** means the profile is activated automatically.
11. Select the **Primary profile**.

Select a profile from the **Primary** scroll list. This profile is used by this network user group as a first choice, when possible.

There are 5 predefined profiles (4 in the SAILOR 250 FleetBroadband): Standard, Streaming 32 kbps, Streaming 64 kbps, Streaming 128 kbps and Streaming 256 kbps (only SAILOR 500 FleetBroadband). Additionally, you can define your own custom profiles.

Important

If you have selected a Streaming connection as your primary profile, the LAN interface will be running a Streaming connection until you stop it or disconnect the interface. However, if you select one or more secondary profiles, you can set up your traffic flow filter so that it will only use the Streaming profile for certain types of traffic.

For further information on profiles and traffic flow filters, see *Using profiles* on page 139 and *Using traffic flow filters* on page 143.

12. Select the **Secondary profile**.

To select more than one secondary profile, press and hold **Ctrl** or **Shift** while selecting.

Note

If you have selected both a primary and one or more secondary profiles you must define a traffic flow filter before you can establish a valid connection.

The Context Identifiers (CIDs) for the selected primary and secondary profiles are listed under **Profile CIDs**.

13. Click **Apply**.

Managing network devices

Overview

A network device, in this context, is an Ethernet hardware device, identified by a unique MAC address.

When a network device with dynamic IP address is connected to the terminal, it is automatically listed in the Network devices list.

Viewing the list of network devices

To view the list of network devices, select **SETTINGS > Network devices**.

All network devices that have been connected to the terminal are listed here.

The screenshot shows the Thrane & Thrane web interface. At the top, there is a header with the company name and a signal strength indicator. Below the header is a sidebar menu with the following items: DASHBOARD, PHONE BOOK, MESSAGES, CALLS, SETTINGS, LAN, Port forwarding, Network devices, Network classification, Network user groups, Phone/Fax, ISDN, Common, IP handsets, Discrete I/O, Upload, Satellite selection, ADMINISTRATION, and HELPDESK. The main content area is titled 'LOCKED IP ADDRESSES' and contains a table with columns for IP address and MAC address. Below this is another section titled 'NETWORK DEVICES' with columns for IP address, MAC address, and Device Name. Each device entry has a 'Lock ip to mac address' link. The table data is as follows:

LOCKED IP ADDRESSES	
IP address	MAC address
192.168.11.4	00:18:F8:09:09:09
192.168.11.11	00:18:F8:09:BF:0A
192.168.11.12	00:18:F8:09:09:0C

NETWORK DEVICES			
IP address	MAC address	Device Name	
192.168.0.2	00:18:F8:09:BD:D4	device-0	Lock ip to mac address
192.168.11.1	00:18:F8:09:09:06	device-1	Lock ip to mac address
192.168.11.2	00:18:F8:09:09:07	device-2	Lock ip to mac address
192.168.11.3	00:18:F8:09:09:08	device-3	Lock ip to mac address
192.168.11.4	00:18:F8:09:09:09	device-4	
192.168.11.5	00:18:F8:09:09:0A	device-5	Lock ip to mac address
192.168.11.6	00:18:F8:09:BF:07	device-6	Lock ip to mac address
192.168.11.7	00:18:F8:09:BF:05	device-7	Lock ip to mac address
192.168.11.8	00:18:F8:09:B8:07	device-8	Lock ip to mac address
192.168.11.9	00:18:F8:09:BF:03	device-9	Lock ip to mac address
192.168.11.10	00:18:F8:09:0A:07	device-10	Lock ip to mac address
192.168.11.11	00:18:F8:09:BF:0A	device-11	
192.168.11.12	00:18:F8:09:09:0C	device-12	

Locking an IP address to a MAC address

When the device is locked to an IP address, the terminal will always assign this IP address to the MAC address of this device (if DHCP is enabled and the Internet connection is not a Bridge mode connection).

To lock a device to its current IP address, click the link next to the device. The device is then locked to the current IP address and added to the list of locked IP addresses at the top of the page.

To unlock a device from the IP address, click **Delete** next to the device in the **LOCKED IP ADDRESSES** list.

Using the network classification table

Overview

The network classification table is used for making an association between network devices and network user groups.

Each entry in the table shows MAC address, IP address, LAN port and network user group.

When a network device is connected, the terminal runs through the network classification table to check if the new connection matches any of the entries in the table. When a match is found, the terminal establishes a PDP context and the device is ready for use with the terminal.

Adding or editing an entry in the network classification table

To add a new entry to the table or to edit an existing entry, do as follows:

1. Select **SETTINGS > Network classification table**.

The screenshot shows the Thrane & Thrane web interface. The top navigation bar includes: DASHBOARD, PHONE BOOK, MESSAGES, CALLS, SETTINGS, LAN, Phone/Fax, ISDN, Common, and IP handsets. The main content area is titled "NETWORK CLASSIFICATION TABLE" and contains the following table:

MAC address	IP address	LAN port	Network user group	
*	*	3	Group 0	▼ Edit/Delete
*	*	2	Group 0	▲ Edit/Delete
*	*	*	Default group	

Below the table, there is a red warning message: "Changes to this page only take effect after reboot".

The network classification table shows which devices are associated with which LAN ports and network user groups. An Asterisk (*) is a “wild card”, meaning that any value is accepted.

2. Click **Edit** next to the entry you want to edit, or click **Add** at the bottom of the list.

EDIT ENTRY

Enter values below or select a device from the list of known network devices to use that as a template. If a field is left empty it will be considered a wild card

MAC address

IP address

LAN port

Network user group

NETWORK DEVICES

IP address	MAC address	Device Name	
192.168.0.2	00:18:F8:09:BD:D4	device-0	Add
192.168.11.1	00:18:F8:09:09:06	device-1	Add
192.168.11.2	00:18:F8:09:09:07	device-2	Add
192.168.11.3	00:18:F8:09:09:08	device-3	Add
192.168.11.4	00:18:F8:09:09:09	device-4	Add
192.168.11.5	00:18:F8:09:09:0A	device-5	Add
192.168.11.6	00:18:F8:09:BF:07	device-6	Add
192.168.11.7	00:18:F8:09:BF:05	device-7	Add
192.168.11.8	00:18:F8:09:B8:07	device-8	Add
192.168.11.9	00:18:F8:09:BF:03	device-9	Add

3. Click **Add** next to a network device you want to use, or type in the MAC address manually at the top of the page.

Note

If you leave a field empty, it is the same as a “wild card” and it will be shown as an Asterisk in the Network classification table. Unless you are using a Static IP address, the IP address field should always be left empty.

4. Select the **LAN port** and **Network user group** you want to associate with the device.
Network user groups are created and defined in the Network user group page. See *Setting up the network user groups* on page 113.
5. Click **Apply**.

Removing an entry in the network classification table

In the **network classification table**, click **Delete** next to the entry you want to delete.

Changing the priority in the network classification table

To change the priority of an entry, click the up or down arrow next to the entry.

Thrane & Thrane

SIGNAL: 00000000

NETWORK CLASSIFICATION TABLE

MAC address	IP address	LAN port	Network user group	
*	*	3	Group 0	▼ Edit/Delete
*	*	2	Group 0	▲ Edit/Delete
*	*	*	Default group	

[Add](#)

Changes to this page only take effect after reboot

Using the web interface

Connections are evaluated in the order they are listed. The first entry (and **only** the first entry) that matches the properties of the connected device is applied, meaning that the connection will be using the settings of the user group assigned to that entry.

The Default user group is always last, so it is only used if none of the other entries match the properties of the connected device.

Definitions for network terms

APN (Access Point Name)

The APN is used by the network user to establish the connection to the required destination network. This means that the terminal must know the APN in order to be able to connect to the destination network. APNs are provided from the Airtime Provider. They may also be defined on the SIM card.

Header compression

The Header of a data packet contains control information belonging to that packet. The information in the Header can take up a considerable amount of bandwidth. In order to save bandwidth, you can use Header Compression, meaning you compress the header information, leaving some of the information out.

You can select whether or not to use Header Compression for your data transmission.

- **Header Compression enabled:** Recommended for low-noise applications. If you select Header Compression enabled, you will be using less bandwidth on header information, leaving more bandwidth for the actual payload. However, if the environment is noisy, the system will have to retransmit information, and you may end up using more bandwidth than without Header Compression.
- **Header Compression disabled:** Recommended in noisy environments. If Header Compression is disabled, the system will be less sensitive to noise.

Profiles

A profile is a collection of Quality of Service (QoS) settings and other settings defining the mode in which data is transmitted on an interface. For example, a profile is used to define whether a connection should be a Standard or Streaming connection.

You can select between a number of predefined profiles or define your own profiles for your data transmission.

Note

If you have selected more than one profile (one primary and one or more secondary profiles) for an interface, you must define a traffic flow filter before you can establish a valid connection.

You need an Administrator password to define profiles and traffic flow filters.

NAT (Network Address Translation)

NAT enables a local-area network to use one set of private IP addresses for internal traffic and an assigned or static IP address for external traffic. The built-in NAT module in the terminal makes all necessary address translations between the local-area traffic and the external traffic.

If more than one user is connected, you must select a network user group with **Router mode** to use the NAT of the terminal.

Uploading software

Introduction

You can upload software from your computer to the terminal without entering the PIN. However, if your SIM card requires a PIN and the PIN is not entered, you must enter the Administration user name and password.

The web interface also offers the possibility of downloading the latest software version from the Internet to your computer.

The next pages describe how to upload software from your computer to the terminal and how to download software from the Internet to your computer.

Uploading software from your computer

To upload software from your computer to the terminal, do as follows:

1. Download the new software as described in the next section, or acquire the software from Thrane & Thrane and save it on your computer.
2. Open the web interface and do one of the following:
 - If the PIN has been accepted (or a PIN is not required), select **SETTINGS > Upload** from the left navigation pane.
 - If a PIN is required and the PIN has not been entered, select **ADMINISTRATION**, enter the Administration PIN and password and click **Logon**.
The default user name is **admin** and the default password is **1234**. Then select **Upload** from the left navigation pane.

The SOFTWARE UPLOAD page opens.

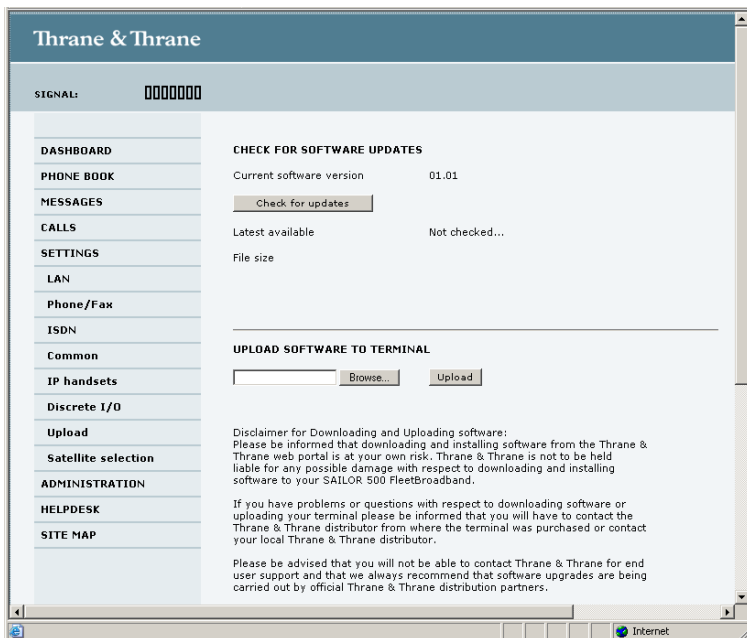

3. In the field **UPLOAD SOFTWARE TO TERMINAL**, click **Browse...**
4. Browse to the new software version and accept it.
5. Click the **Upload** button.
6. Note that the upload procedure takes a couple of minutes.

Note

When upload is done, your terminal automatically restarts with the new software.

Downloading software from the Internet

Important

The terminal uses your BGAN airtime subscription to download the new software from the Internet. Note that it can take several minutes to download the software.

To download the latest software from the Internet to the terminal, do as follows:

1. Make sure you have a connection to the Internet from your terminal.
2. Open the web interface and select **SETTINGS > Upload** from the left navigation pane.

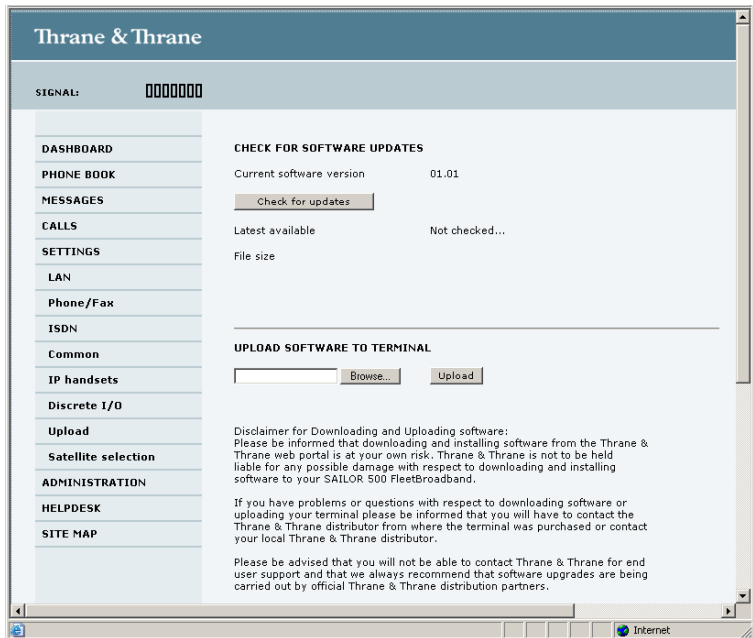

3. Click **Check for updates**.

The terminal will now connect to the Internet through the BGAN network, using your airtime subscription. It may take a minute or two to obtain the new software version.

When the new software version is found, the web interface shows the new software version and a link for downloading the software.

4. Click the link to download the new software to your computer.
After saving the software, follow the procedure in the previous section (*Uploading software from your computer*) to upload the software from the computer to your terminal.

Selecting the preferred BGAN satellite

Overview

By default the terminal is set up to automatically find the most appropriate satellite to connect to (“Auto” mode). However, if you are located in an area with more than one BGAN satellite available, you can select the satellite you prefer to use when registering on the BGAN network.

To select the preferred BGAN satellite

Do as follows:

1. Select **SETTINGS** > **Satellite selection** from the left navigation pane.

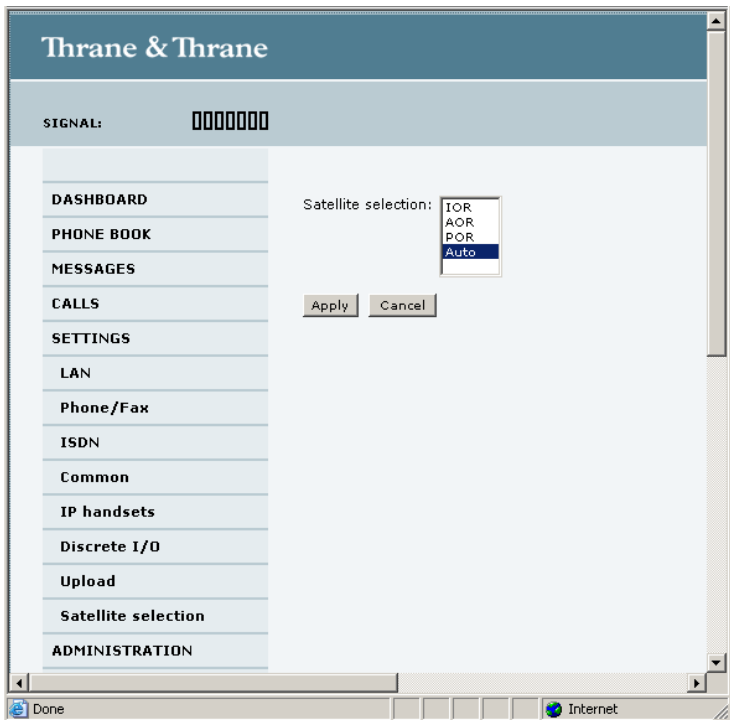

2. Select the satellite you prefer to use.

If you select **Auto** (the default setting) the SAILOR FleetBroadband system automatically uses the most appropriate satellite.

Note that at this writing the POR satellite is not yet available.

Important

If you have any ongoing calls or data sessions, they will be terminated when you click Apply!

3. Click **Apply**.

The SAILOR FleetBroadband terminates all ongoing connections and deregisters from the current satellite before registering on the new satellite.

Note

If you have selected a satellite, your SAILOR FleetBroadband system will only try to establish a connection to the selected satellite. This means that if the antenna is outside the coverage area for that satellite, the SAILOR FleetBroadband system will not be able to register with the BGAN network.

Administration

Accessing the administration settings

Logging on

The Administration settings require an Administration user name and password.

1. Select **ADMINISTRATION** from the left navigation pane.
2. Enter the Administration user name and password.

The default user name is **admin** and the default password is **1234**.

If you have forgotten the administrator password, you can reset the password by clicking the link at the bottom of the page. For further information, see the next section *Resetting the Administrator password*.

3. Click **Logon**.

The Administration page is now updated to let you change the user name and password, Save/load a configuration or log off Administration.

Resetting the Administrator password

If you have forgotten the administrator password, do as follows:

1. Contact your supplier for a reset code.
Please report the serial number and IMEI number of the terminal.
You can find the serial number and IMEI number in the **Dashboard**.
2. Click the link **Forgot administrator password?** at the bottom of the ADMINISTRATOR LOGON page (see the previous section).

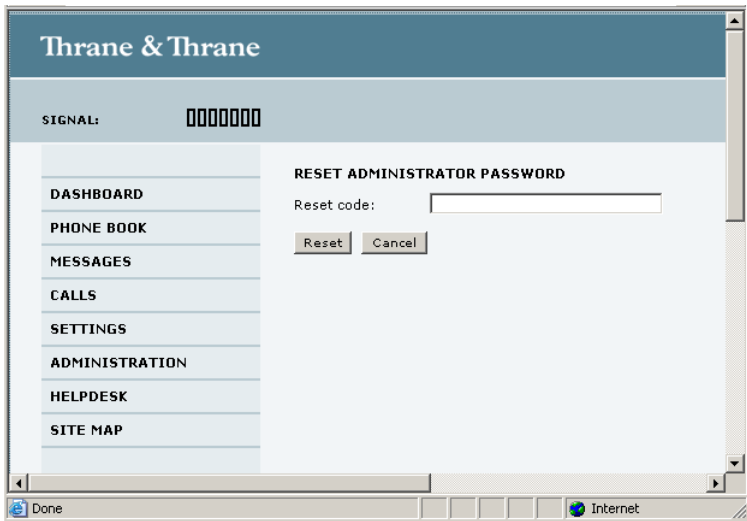

3. Type in the reset code obtained from your supplier and click **Reset**.
4. Type in the user name **Admin** and the default password **1234**.
5. Click **Logon**.
For information on how to change the password, see the next section *Changing the administrator password*.

Changing the administrator password

Do as follows:

1. After entering the Administrator user name and password in the **ADMINISTRATION** page, locate the section **Change administrator logon**.

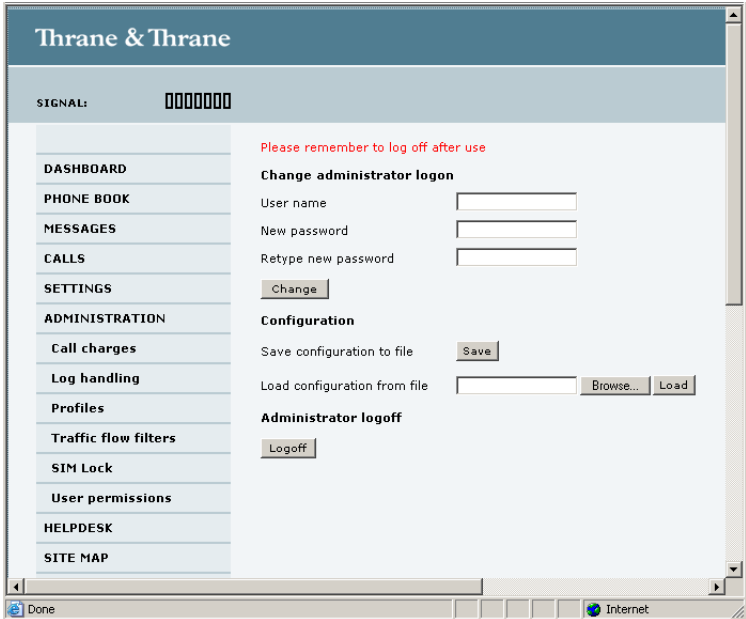

2. Type in the existing user name.
 3. Type in the new password and retype it on the next line.
 4. Click **Change**.
- At the next logon the new password is required.

Saving a configuration to a file

If you need to reuse a configuration in another terminal of the same type, you can save your current configuration to a file, which can then be loaded into the other terminal.

Do as follows:

1. In the **ADMINISTRATION** page, under **Configuration**, click **Save**.
2. Accept the default destination file name or type in the destination file name and location.
3. Click **OK**.

The configuration is now saved to a file. This file is used to load the configuration into another terminal. See the next section.

Loading a configuration from a file

1. In the **ADMINISTRATION** page, under Configuration, click **Load**.
2. Click **Browse...** to browse to the file you want to import. Then click **Open**.
3. Click **Load**.

The new configuration is now loaded into your terminal.

Logging off administration

If you have not entered anything for 30 minutes under ADMINISTRATION, you are logged off automatically.

To log off manually, click **Logoff** under Administrator logoff in the **ADMINISTRATION** page.

Call charges

If you know the tariff for your subscribed services, you can enter these tariffs in the web interface and automatically calculate the charges for your calls and data sessions.

Note

Thrane & Thrane does not take responsibility for the correctness of the estimated charges. This calculation is only a rough estimate of the charge, based on the tariff entered by the user. Also, the Airtime Provider may have different methods of calculating the charge.

Do as follows:

1. From the left navigation pane, select **ADMINISTRATION > Call Charges**.

The screenshot shows the 'Call Charges' configuration page in the Thrane & Thrane web interface. The left navigation pane is expanded to 'ADMINISTRATION', with 'Call charges' selected. The main content area displays the following information:

- SIGNAL:** 0000000
- DASHBOARD**
- PHONE BOOK**
- MESSAGES**
- CALLS**
- SETTINGS**
- ADMINISTRATION**
 - Call charges
 - Log handling
 - Profiles
 - Traffic flow filters
 - SIM Lock
 - User permissions
- HELPDESK**
- SITE MAP**

The billing details section contains the following form fields:

- Currency:** EUR (for display purposes only)
- Standard voice:** EUR 0.00 per minute
- 3.1 kHz Audio:** EUR 0.00 per minute
- Standard data:** EUR 0.00 per MegaByte (1000 kB)
- Streaming 32:** EUR 0.00 per minute
- Streaming 64:** EUR 0.00 per minute
- Streaming 128:** EUR 0.00 per minute
- Streaming 256:** EUR 0.00 per minute

Buttons: Apply, Cancel

Disclaimer: Please note that the estimates made on this basis are only indicative and Thrane & Thrane cannot be held liable for any differences between these and your actual bill. If you change the currency or the rates, these changes will also be applied to historical figures, so you may want to save the call log to a separate file to keep track of historical data.

2. Select the currency from the **Currency** drop-down list.
3. Enter the tariff for each of the services.

4. Click **Apply**.

The entered tariffs are used for estimating the charges for calls and data sessions. The estimated charge is listed for each call or data session in the call log. For further information, see *Viewing the lists of calls* on page 77.

Log handling

1. From the left navigation pane in the **ADMINISTRATION** page, select **Log Handling**.

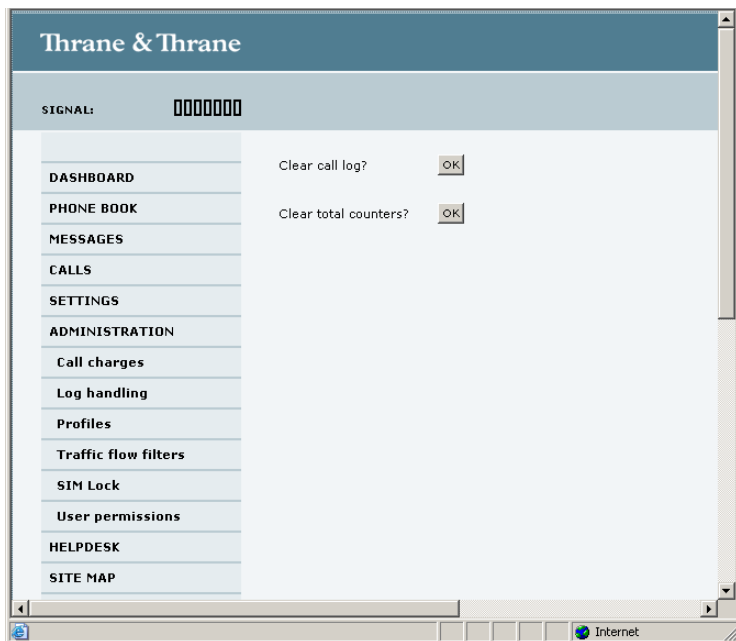

2. To clear the Call log, click **OK** next to **Clear call log?**
3. To clear the total counters, click **OK** next to **Clear total counters?**.
This will reset the **Time connected** counters on the Calls page.

Using profiles

What is a profile?

A profile is a collection of Quality of Service (QoS) settings and other settings defining the mode in which data is transmitted. For example, a profile is used to define whether the connection is a Streaming connection or a Standard connection.

You can select between a number of predefined profiles or define your own profiles for your data transmission.

If no traffic flow filters are defined, the Primary profile for a user group is used for all traffic from that user group. See *What are traffic flow filters?* in the next section.

For further information on profiles, refer to the 3GPP standard TS 23.107.

Selecting the profiles for a network user group

When you set up a network user group, you select the profiles to use for that user group. You select a Primary profile and optionally one or more Secondary profiles.

For further information on how to select the profiles, see *Managing LAN network users* on page 111.

Defining new profiles

When you define your profiles you can select **Subscribed** for many of the settings. If you select Subscribed, the value given in your Airtime subscription will automatically be used.

Note

For SAILOR 250 FleetBroadband, the maximum Streaming bit rate is 128 kbps.

To define a new profile, do as follows:

1. From the left navigation pane, select **ADMINISTRATION > Profiles**.

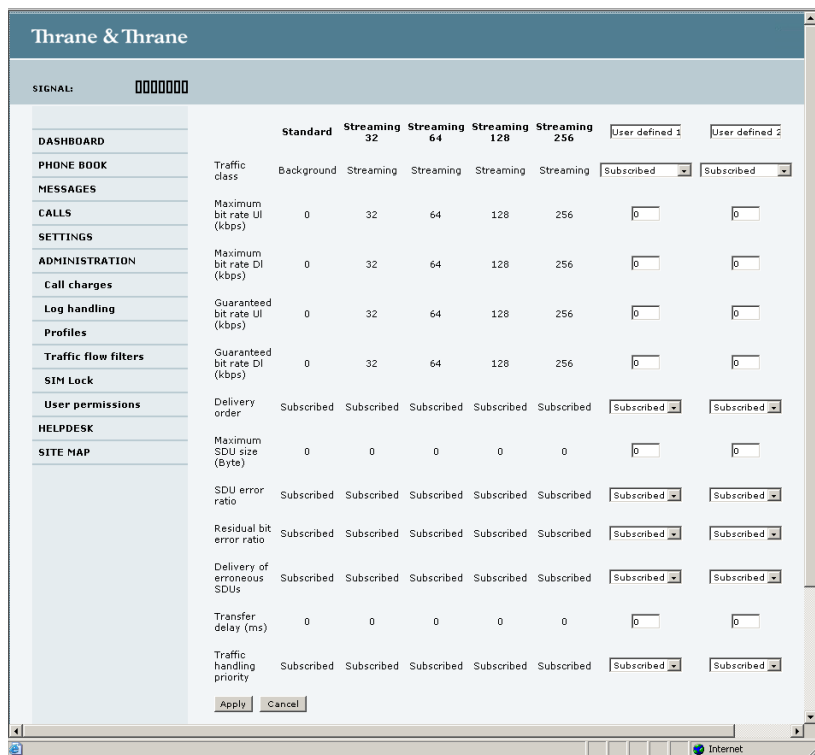

2. In one of the **User defined** columns, fill in the top field with the name of your profile.

3. In the **Traffic class** row of your new profile, select a class from the drop-down list.

Important

For best performance, choose the right traffic class for your application. In general, Standard data (Background) is best suited for TCP/IP applications, and Streaming data is best suited for UDP traffic, e.g. live video or audio.

You may select one of the following:

- **Conversational** is real-time two-way conversation. It is primarily used for voice over IP and video conferencing.
 - **Streaming** is real-time one-way communication. It is primarily used for video and audio.
 - **Interactive** is two-way communication (not real-time). It is used for communication that is not very delay-sensitive, such as web browsing, data base retrieval and server access. Examples of machines interaction with remote equipment are: polling for measurement records and automatic data base enquiries (tele-machines).
 - **Background** is used for data which is not delay-sensitive, such as E-mails, SMS, download of databases and reception of measurement records.
4. Type in the bit rates in kbps in the following rows:

Note

For SAILOR 250 FleetBroadband the maximum allowed bit rate is 128 kbps.

- **Maximum bit rate ul (kbps)** is the maximum upload bit rate allowed for this profile.
- **Maximum bit rate dl (kbps)** is the maximum download bit rate allowed for this profile.
- **Guaranteed bit rate ul (kbps)** is the guaranteed upload bit rate needed for this profile.
- **Guaranteed bit rate dl (kbps)** is the guaranteed download bit rate needed for this profile.

Note

When you click Apply, the bit rate values you typed in may be rounded off because only certain values are allowed.

5. In the **Delivery order** row, select from the scroll list whether or not data should be delivered in the same order it was sent. Yes means the data packets are delivered in the same order they were sent.
6. In the **Maximum SDU size (byte)** row, type in the maximum allowed packet size in Bytes (rounded off to nearest 10). The maximum packet size possible is 1520.
7. In the **Delivery of erroneous SDUs** row, select one of the following from the list:
 - **Yes** means packets are allowed to contain errors. This setting is suitable for delay-sensitive transmission, because the need for retransmission is limited. The SDU Error settings in step 8 and step 9 will apply.
 - **No** means packets are not allowed to contain errors, and the SDU Error setting in step 8 will **not** be applied. This setting is suitable where error-free transmission is important and delays are accepted.
 - **No detect** means that errors will not be detected, and the SDU Error setting in step 8 will **not** be applied.
8. If you selected **Yes** in step 7, select from the **SDU error ratio** drop-down list the fraction of a packet allowed to be lost or erroneous.
9. Select from the **Residual bit error ratio** drop-down list the undetected bit error ratio of a packet. If no error detection is requested, Residual bit error ratio indicates the bit error ratio in the delivered packets.
10. In the **Transfer delay (ms)** row, type in the delay in ms. This is the delay from the time data is received in the terminal until it arrives at the receiving end.
 - If the Transfer delay is 500 ms, error correction is disabled.
 - If the Transfer delay is 4000 ms, error correction is applied.
11. In the **Traffic handling priority** row, select from the drop-down list which priority this connection should have.
12. Click **Apply**.

The new profile is now added, and can be selected from the lists of primary and secondary profiles when you set up your interfaces.

Using traffic flow filters

What are traffic flow filters?

When more than one type of traffic is needed, you must use both a primary and one or more secondary profiles. For the Core network and the terminal to classify packets received from the external network into the proper profile, you need a traffic flow filter.

A list of traffic flow filters consists of one to eight packet filters, each identified by a unique packet filter identifier. A packet filter also has an evaluation precedence index that is unique within all traffic flow filters associated with the profiles that share the same PDP (Packet Data Protocol) address. Information of source, destination, type of service etc. is combined in each packet filter in the list.

Purpose of the traffic flow filters

The purpose of the traffic flow filters is to assign different priorities to different types of traffic, in order to optimize performance.

Example: When you are browsing the Internet, a Standard data connection is normally sufficient. However, to have a video conference you may need a Streaming connection in order to obtain a direct connection without interruptions. Your traffic flow filters can define these priorities, so that your connection automatically switches to Streaming e.g. when you have a video conference.

Defining traffic flow filters

To define the traffic flow filters, do as follows:

1. From the left navigation pane, select **ADMINISTRATION > Traffic flow filters**.

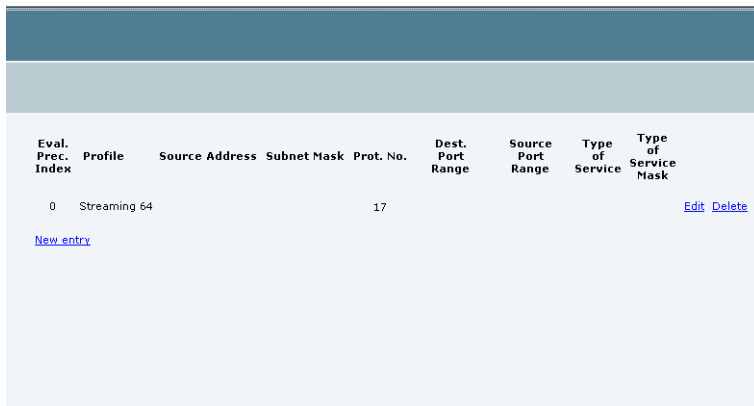

2. Click the link **New entry**.

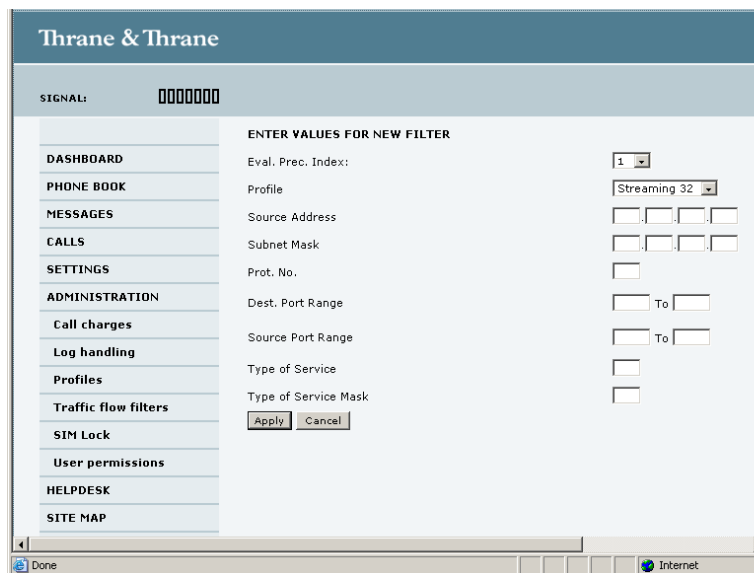

3. Type in an Evaluation Precedence Index in the **Eval.Prec. Index** column.

Note

This field is mandatory. Each filter must have a different Evaluation Precedence Index.

4. Select the **Profile** from the scroll list.
The available profiles are the profiles listed in the ADMINISTRATION > Profiles page.
5. Fill in one or more of the following fields to define the filter.
The allowed ranges appear in hover text when you pass the mouse over the fields.
 - **Source address + Subnet mask.**
 - **Protocol number.**
 - **Destination port range** (From and To). Note that Source and Destination are relative the core network. This means that Destination is your terminal.
 - **Source port range** (From and To).
 - **Type of Service + Type of Service mask.**

For further information on the principles and parameters of the traffic flow filters, refer to the 3GPP standards TS27.007 V4.2.0 and TS 23.060 V4.7.0.
6. Click **Apply** at the bottom of the page.

Setting up user permissions

You can restrict access to parts of the web interface for non-administrator users.

To set up the user permissions, do as follows:

1. From the left navigation pane, select **ADMINISTRATION > User permissions**.

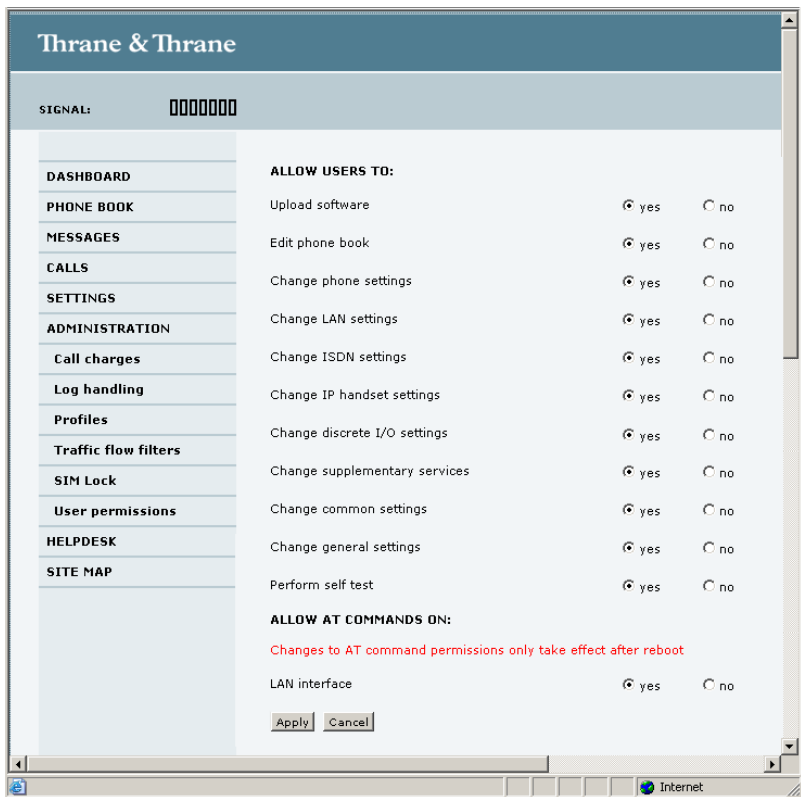

2. For each item under **ALLOW USERS TO:**, select
 - **yes** to allow access or
 - **no** to block access to the settings.

3. Under **ALLOW AT COMMANDS ON:**, select
 - **yes** to allow the use of AT commands on the LAN interface, or
 - **no** to block the use of AT commands on the LAN interface.

Note that this setting does not take effect until the terminal is restarted.

4. Click **Apply**.
The settings to which access is denied are now greyed out for the non-Administrator user.

Help desk and diagnostic report

Accessing the Help desk

If you need help **with airtime-related issues** you may call the Help desk. By default, the Help desk is the phone number for your Airtime Provider, if it is available on the SIM card.

Select **HELP DESK** from the left navigation pane.

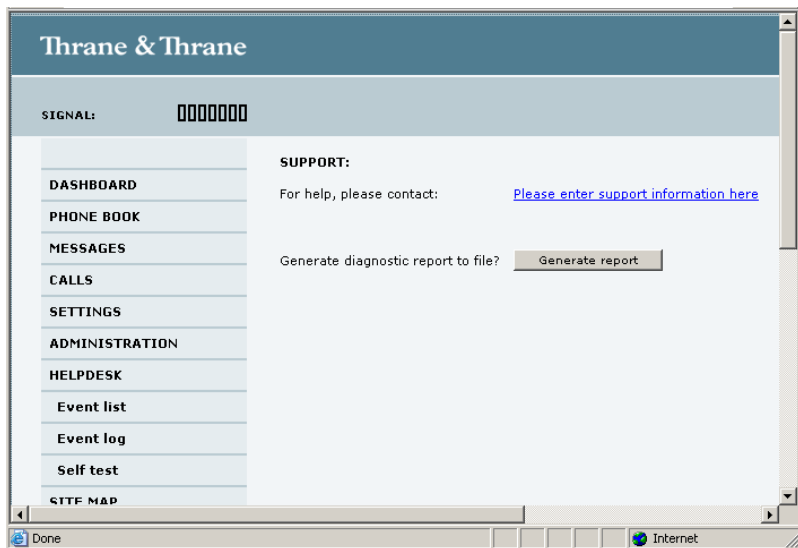

If the Help desk number is available on the SIM card, the number is displayed as a link. To change the number, click the link, change the number and click **Apply**.

If you need help **with terminal- or antenna-related issues** you should call your local distributor.

Generating a diagnostic report

If you want to generate a diagnostic report, do as follows:

1. Click **Generate report** from the **HELP DESK** page.
In some browsers the file may open directly in your browser. If it does, choose **File > Save As** to save the file.
2. Choose a location for the file and save it.

The diagnostic report contains relevant information for troubleshooting. Please enclose this file when you are reporting an error.

Event logging and self test

Viewing the Event list or the Event log

Overview

When an event is registered, the web interface shows an event icon  in the icon bar as long as the event is active.

The **Event list** only shows events that are currently active, whereas the **Event log** shows the history of events that have occurred.

Event list

To view the event list, click the event icon from the icon bar at the top of the web interface, or select **HELPDESK > Event list** from the left navigation pane.

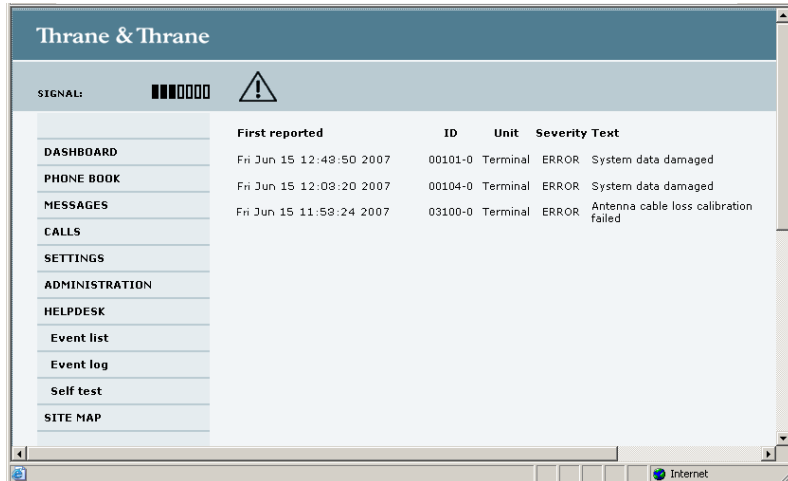

The Event list page shows a detailed list of active events including the time of the first occurrence, ID and severity of the event message, and a short text describing the error. For more information on the event messages, refer to *Event messages* on page 170.

Event log

To view the Event log, select **HELPDESK > Event log** from the left navigation pane.

The **Event log** shows the same information as the Event list, but also includes events that occurred in the past and are no longer active. Additionally, it lists events of informational character, describing normal phases of operation for the terminal.

Self test

The Self test performs system test on the SAILOR FleetBroadband system, similar to the tests that are performed during the Power On Self Test (POST).

Important

The terminal will reboot when performing the self test. All ongoing calls or data sessions will be terminated.

To activate a Self test, do as follows:

1. Select **HELPDESK > Self test**.

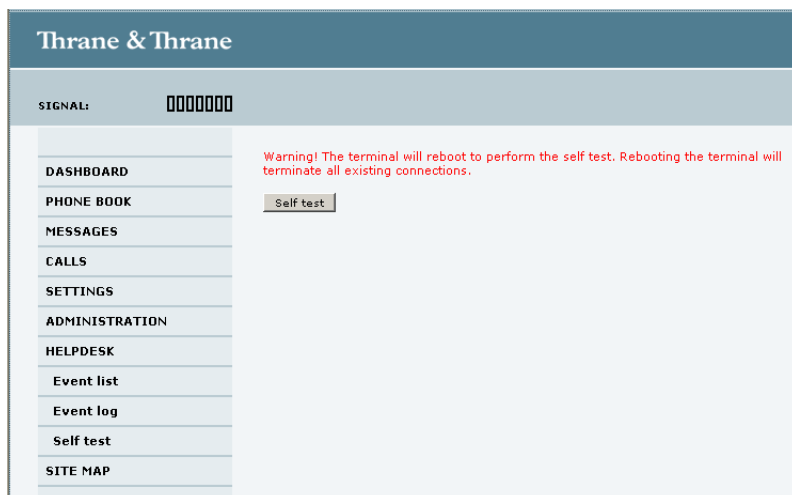

2. Click **Self test**.
3. Click **OK** in the Warning dialog.
The terminal now performs a self test and resets the terminal.

What's next?

This chapter has explained how to use the web interface for setup and use of the system. You should now be able to set up the system, check status, read and send SMS messages, use the phone book and much more.

The following chapter, *Troubleshooting*, provides guidelines for troubleshooting, an overview of the different means of status signalling, and a list of available spare parts and accessories.

Troubleshooting

In this chapter

This chapter gives guidelines for troubleshooting and provides an overview of the different means of status signaling. It also lists available spare parts and accessories.

Getting support

Overview

If this manual does not provide the remedies to solve your problem, you may want to contact your Airtime Provider or your local distributor.

Airtime support

If you need assistance from your Airtime Provider, please call the help desk. To see the help desk number, enter the web interface of your terminal and select **HELP DESK**. This help desk number is either taken from the SIM card or entered manually. If no number is available under HELP DESK, check your Airtime subscription for a contact number.

System support

If you need assistance with problems caused by the terminal or antenna, please call a distributor in your area.

A list of certified partners and distributors is available on Thrane & Thrane's web site: www.thrane.com. Select **Maritime** and select **Distributors** from the top menu bar.

Uploading software

Viewing software version status

To view the version of the embedded software in the terminal, connect a computer, enter the web interface and see the **Software version** field in the **Dashboard**.

Uploading software using the web interface

You can upload software from the web interface.

If you have an Administrator user name and password you do not need to insert a SIM card nor to enter the PIN to be able to upload software.

For further information, see *Uploading software* on page 126.

Part numbers

System units

TT-3740A SAILOR[®] 500 FleetBroadband system

Item	Part number
SAILOR 500 FleetBroadband antenna	403052A
SAILOR FleetBroadband terminal	403738A

TT-3742A SAILOR[®] 250 FleetBroadband system

Item	Part number
SAILOR 250 FleetBroadband antenna	403050A
SAILOR FleetBroadband terminal	403738A

TT-3670A IP handset and cradle

Item	Part number
Thrane & Thrane IP Handset	403672A
Thrane & Thrane IP Cradle	403674A

Spare parts, SAILOR[®] 500 FleetBroadband

Antenna spare parts

Item	Part number
HPA module	S-62-124671
ATB/LNA module	S-88-126533-A
GPS module	S-60-124765

Cables

Item	Part number
Antenna cable, 30 m	37-126525
DC cable	37-125999
LAN cable, 2 m	37-203213

Spare parts, SAILOR®250 FleetBroadband

Cables

Item	Part number
Antenna cable, 25 m	37-204567-025
DC cable	37-125999
LAN cable, 2 m	37-203213

Options and accessories

Cables

Item	Part number
Antenna cable RG223/U, 14 m.	403722A - option 943
Antenna cable RG214/U, 50 m.	403722A - option 947
Antenna cable S-10162-B-11, 92 m	403722A - option 955
DC cable, 6 m.	403722A - option 009

Cable support

Item	Part number
Basic cable support kit ^a	673738A
Extended cable support kit	403738A - option 940

- a. Included in the basic package for both SAILOR 500 FleetBroadband and SAILOR 250 FleetBroadband.

SAILOR[®] 250 FleetBroadband *mast mount kit*

The mast mount kit interfaces to a 1½” tube (OD 48.3 mm - absolute maximum OD 52 mm).

Item	Part number
Mast mount kit	403742A-920

Troubleshooting guide

The below table provides information on some of the problems that might occur, including possible causes and remedies to solve the problems.

Problem	Possible Cause	Remedy
No signal or weak signal from the BGAN satellite.	The view to the satellite is blocked.	Make sure the antenna has a clear view in all directions. See the installation manual for details.
	The antenna cable is not properly connected.	Check that both ends of the cable are connected properly according to the guidelines in the Installation manual. Also check that no connectors are damaged.
	The system is set up to use one specific satellite, but the system is outside coverage from that satellite.	Enter the web interface. Select SETTINGS > Satellite selection . Select Auto and click Apply . The system will now search for the satellite with the strongest signal and attempt to connect.
No transmission on the BGAN network is possible.	The Radio silence function is activated from an external device connected to the I/O interface of the terminal.	If the Radio silence function should not be activated, deactivate it from the external device.

Problem	Possible Cause	Remedy
Connection to the Internet cannot be established.	Your network user group does not allow Internet access.	The Administrator can access and change network user groups in the built-in web interface of the terminal.
256 kbps Streaming does not work	The elevation angle to the satellite is too low.	Availability of 256 kbps Streaming can only be guaranteed in areas with over 15 degrees elevation.
128 kbps Streaming does not work on SAILOR 250 FleetBroadband	The elevation angle to the satellite is too low.	Availability of 128 kbps Streaming on SAILOR 250 FleetBroadband can only be guaranteed in areas with over 15 degrees elevation.
The web interface cannot be accessed.	The browser is configured to use a proxy server.	For Microsoft Internet Explorer, select Tools > Internet Options > Connections > LAN Settings and uncheck Use a proxy server for your LAN .
	You have entered a wrong IP address.	Check the IP address and re-enter it. If you do not have the correct IP address, you can set the IP address temporarily to the default address (192.168.0.1) by pressing the Reset button. See <i>Function of the Reset button</i> on page 184.
	You are connected using VPN	Close down your VPN connection.

Problem	Possible Cause	Remedy
A Phone/Fax connection cannot be established.	The cable is not properly connected.	Connect the cable.
	The cable type or connector type is not correct.	For information on the correct type of connector and cable, refer to the installation manual.
	Incoming calls: The call type used for the call is not selected in the web interface.	Make sure the call type used for calls to the terminal is selected in the web interface. Access the web interface and select SETTINGS > Phone/Fax . Then, for each of the two ports, select the call type for incoming calls.
	SAILOR 250 FleetBroadband: If you are located in a low elevation area (<20°), 3.1 kHz Audio is not supported.	Use Standard voice in stead of 3.1 kHz Audio when you are located in areas with low elevation (< 20°).

Problem	Possible Cause	Remedy
An ISDN connection cannot be established	The cable is not properly connected.	Connect the cable.
	You have connected to the LAN interface.	Connect the cable to the interface marked ISDN.
	The cable type or connector type is not correct.	For information on the correct type of connector and cable, refer to the installation manual.
	Incoming phone calls: The call type used for the call is not selected in the web interface.	Make sure the call type used for calls to the terminal is selected in the web interface. Access the web interface and select SETTINGS > ISDN . Then select the call type for incoming calls.
	SAILOR 250 FleetBroadband: The ISDN service is not supported.	Use another service. You may still use the ISDN interface on the terminal, but only Standard voice and 3.1 kHz Audio are available.
No phones are ringing on incoming calls	The Mute function is activated from an external device connected to the I/O interface of the terminal.	If the Mute function should not be activated, deactivate it from the external device.

Problem	Possible Cause	Remedy
A LAN connection cannot be established.	The cable is not properly connected.	Connect the cable.
	The cable type or connector type is not correct.	For information on the correct type of connector and cable, refer to the installation manual.
An IP handset connection cannot be established.	The cable is not properly connected.	Connect the cable.
	You have connected to the ISDN interface.	Remove the cable and connect to one of the LAN connectors instead.
	There is no power (PoE) in the LAN interface. The reason may be that there is not enough power to supply PoE for the LAN interface.	<p>Check that the input voltage is within the specified range (10.5 - 32 V DC; 14 A - 5.5 A).</p> <p>Check that you do not have too many power-consuming devices connected. The maximum available output power on the LAN (PoE) interface is 32 W if you are using a 12 V supply and 64 W if you are using a 24 V supply. If possible, disconnect other connected devices.</p>

Problem	Possible Cause	Remedy
The Administrator password does not work.	Someone has changed the Administrator password.	<p>If the correct password is not found, you have to reset the password.</p> <p>Contact your supplier for a reset code. You must provide the serial number and IMEI number of the terminal.</p> <p>Then enter the web interface and reset the password as described in: <i>Resetting the Administrator password</i> on page 134.</p>

Status signaling

Overview

There are many ways of troubleshooting if an error occurs. The terminal has different means of status signaling, to help you find the cause of a problem:

- **Indicators.**
- **Event messages.**
- **Event log.**

Indicators, event messages and logs are described in the following sections.

Light indicators

Overview

The terminal has a number of LEDs, placed in the panel at the top of the terminal:

- a green Power indicator,
- a green/red/ orange Terminal indicator,
- a green/red/orange Antenna indicator,
- a green Message indicator and
- 3 LAN indicators for each LAN interface, showing Activity (Green), Link/Speed (Green/Yellow) and PoE (Green/Red).

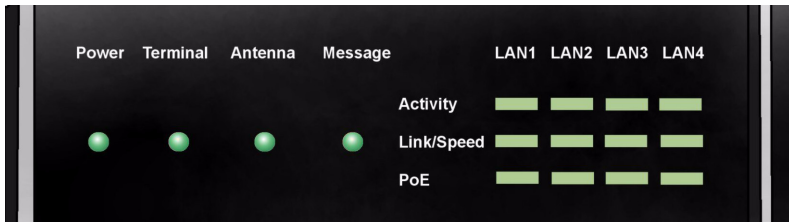

General status indicator functions

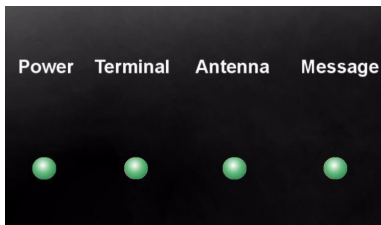

Power indicator

Behavior	Meaning
Green	Power OK.
Flashing green	The terminal is powering up.
Flashing orange	The terminal is closing down.
Off	No power.

Terminal indicator

Behavior	Meaning
Steady green	Ready. BGAN registration completed.
Flashing green	Please wait - process in progress. BGAN registration ongoing.
Orange	Warning - temporary malfunction. User action is required.
Red	Critical error. Check the event log. If the problem is in the SAILOR FleetBroadband system and you cannot solve it, contact your distributor and return the unit for repair if necessary.

Antenna indicator

Behavior	Meaning
Steady green	Tracking. The antenna is ready for use.
Flashing green	Please wait - process in progress. Slow flashing: The antenna is starting up Rapid flashing: Sky scan
Orange	Warning - temporary malfunction. User action is required.
Red	Critical error. Check the event log. If the problem is in the SAILOR FleetBroadband system and you cannot solve it, contact your distributor and return the unit for repair if necessary.

Message indicator

Behavior	Meaning
Flashing green	A new SMS message has arrived.
Off	No new messages, or the unit is off.

LAN indicator functions



Activity indicator

Behavior	Meaning
Flashing green	The LAN port is active.

Link/Speed indicator

Behavior	Meaning
Green	Link speed is 100 Mbps.
Yellow	Link speed is 10 Mbps.
Off	The link is down.

PoE indicator

Behavior	Meaning
Green	The terminal is supplying power to the LAN port.
Red	The connected device requires more power than the terminal can supply to the LAN port.
Off	The terminal is not supplying power to the port.

Event messages

Display of event messages

The terminal can detect events during POST (Power On Self Test) or CM (Continuous Monitoring). When the terminal detects an event that requires your action, it issues an event message.

When your terminal issues an event message, the Terminal indicator or the Antenna indicator in the LED panel on top of the terminal signals the event, according to the tables *Terminal indicator* and *Antenna indicator* in the previous section.

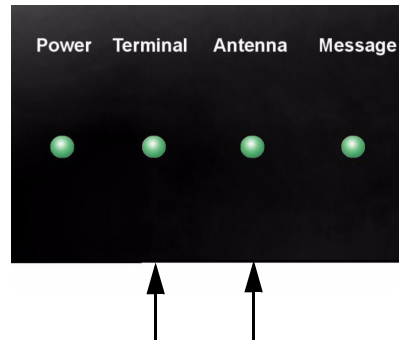

You can see the active event messages in the web interface by clicking the warning symbol in the icon bar at the top in the web interface.

All events are logged in the event log. For information on the event log, see *Viewing the Event list or the Event log* on page 150.

List of events

The following list explains the events that may show in the web interface of the terminal.

ID	Event Text	Explanation	Remedy
00100 to 00199	System data damaged	Important system data is damaged	Do not use the terminal. Contact your distributor.
00210 to 00219	SIM module error	The SIM interface on the terminal cannot be used.	Contact your distributor.
00240 to 00249	Temperature sensor error	The terminal is in danger of overheating.	Do not use the terminal. Contact your distributor.
00260 to 00269	System error	The terminal cannot communicate on the satellite network.	Contact your distributor.
00270 to 00279	Voice module error	Voice services cannot be accessed by the terminal	Contact your distributor.
00280 to 00289	Ethernet module error	The Ethernet interface on the terminal cannot be used.	Contact your distributor.

ID	Event Text	Explanation	Remedy
00300 to 00309	GPS module error	The GPS module is out of function. The terminal cannot obtain a valid GPS position.	Contact your distributor.
00330 to 00339	ISDN failure	The ISDN interface on the terminal cannot be used.	Contact your distributor.
00340 to 00349	2-wire failure	The Phone/Fax interface of the terminal cannot be used.	Contact your distributor.
00350 to 00359	AD9864 calibration data error	Internal error in the receiving part of the terminal.	Contact your distributor if the problem persists.
00360 to 00369	No antenna found	The terminal cannot communicate with the antenna.	<ol style="list-style-type: none"> 1. Check antenna cable between terminal and antenna. 2. Reboot the terminal.
01000 to 01009	Low temperature warning	Low ambient temperature is causing the performance of the terminal to be degraded or halted.	<p>Move the terminal to a warmer location.</p> <p>For information on ambient temperature limits, see the installation manual.</p>

ID	Event Text	Explanation	Remedy
01100 to 01109	High temperature warning	High ambient temperature is causing the performance of the terminal to be degraded or halted.	Move the terminal to a cooler location. For information on ambient temperature limits, see the installation manual.
01110 to 01119	Temperature too high (critical)	Critically high temperature is causing the terminal to shut down.	Move the terminal to a cooler location. For information on ambient temperature limits, see the installation manual. Contact your distributor if the problem persists.
01300 to 01309	No GPS fix	The GPS receiver has not yet achieved position fix.	Make sure the view to the GPS satellites is not blocked. Note that in some cases it may take up to 10 minutes to obtain GPS fix.
01400 to 01409	Satellite signal lost	The SAILOR system no longer receives a signal from the satellite.	Make sure the antenna has a clear view to the satellite.

ID	Event Text	Explanation	Remedy
01500 to 01509	SIM card missing	No SIM card is detected in the SIM slot.	Insert SIM card. If the SIM card is already inserted, try removing and reinserting it.
01600 to 01609	SOS calls only	The SIM card is not accepted by the network. Only emergency calls are allowed.	Enter the PIN and wait for network approval. If the problem persists, contact your Airtime Provider.
01700 to 01709	Registration for voice failed	The SAILOR system has not yet been allowed to register for voice services (Circuit Switched).	If the problem persists, contact your Airtime Provider.
01800 to 01809	Registration for data failed	The SAILOR system has not yet been allowed to register for data services (Packet Switched).	If the problem persists, contact your Airtime Provider.

ID	Event Text	Explanation	Remedy
02000 to 02009	Satellite signal weak	The signal from the satellite is weak.	<p>Check the line of sight to the satellite. Be aware that window glass may reduce the signal level.</p> <p>Check that the antenna is pointed according to the position data. Adjust the position to the highest possible signal strength.</p>
02100 to 02109	Ciphering Off	The network has turned ciphering off.	Do not transmit data that requires ciphering.
02200 to 02209	Ethernet data session failed	Ethernet data session could not be established.	<p>See the call log for the cause of the error. Refer to <i>Viewing the lists of calls</i> on page 77.</p> <p>If the problem persists, contact your distributor.</p>
02900 to 02909	Network failed authentication	The SAILOR system does not accept the network as a valid BGAN network.	<p>Restart the SAILOR system.</p> <p>If the problem persists, contact your distributor.</p>

ID	Event Text	Explanation	Remedy
03500 to 03509	2-wire calibration failure	2-wire calibration failed on the Phone/Fax interface, because of: <ol style="list-style-type: none"> 1. Common mode balance error. 2. The hook is off. 3. Wires are shorted to each other or shorted to ground. 	<ol style="list-style-type: none"> 1. Check the wires to your phone or fax. 2. Put the hook on. 3. Check the wires.
03600 to 03609	2-wire operational failure	The Phone/Fax interface fails to operate, for one of the following reasons: <ol style="list-style-type: none"> 1. Ground shorted. 2. Power overload. 3. Temperature overload. 	<ol style="list-style-type: none"> 1. Check the wires. 2. Wait until the event is cleared; then try again. 3. Wait until the event is cleared; then try again.

ID	Event Text	Explanation	Remedy
08002	One or more ports has PoE disabled due to power limitations	The power supply to the terminal has dropped critically. PoE is disabled to ensure enough power to the antenna.	Ensure a stable power supply to the terminal.
08008	Antenna exceeds voltage threshold	The antenna voltage is either too high or too low.	Check the cable to the antenna. Contact your distributor if the problem persists.
08009	Power Hold-up - the terminal can no longer power the antenna	The power supply to the terminal has dropped for too long. The antenna does not have enough power to function.	Ensure a stable power supply to the terminal.
0800A	Reduce PoE - the terminal reduces PoE with 30W	The input voltage to the terminal is too low. The terminal will lower PoE power from 60 W to 30 W.	Ensure a stable power supply to the terminal.

ID	Event Text	Explanation	Remedy
0800B	PoE Overvoltage protection is activated	Overvoltage is detected in the terminal. The terminal will be shut down in 10 minutes.	Do not use the terminal. Contact your distributor.
0800D	Antenna Overvoltage protection is activated	Overvoltage is detected in the antenna. The terminal will be shut down in 10 minutes.	Do not use the terminal. Contact your distributor.
08010	Undervoltage has been detected	The input voltage has dropped below an acceptable level. The terminal will be shut down in 10 seconds if the situation persists.	Ensure a stable power supply to the terminal.
0801B	Lost connection to the GPS receiver	Communication with the GPS receiver in the antenna is lost.	Contact your distributor if the warning persists.
0801D	Uploading firmware to antenna	New firmware is being uploaded to the antenna. The Event will be cleared when upload has finished.	Contact your distributor if the Event is not cleared within 5 minutes.

ID	Event Text	Explanation	Remedy
0802C	Firmware update still fails after several retries	The terminal was unable to upload new firmware to the antenna.	Contact your distributor.
0802D	Firmware update failed	The terminal was unable to upload new firmware to the antenna.	Reboot the terminal. Contact your distributor if the problem persists.
0802E	Firmware is older than current antenna version	The firmware in the antenna is newer than expected by the terminal.	Update the terminal software.
0802F	Antenna main image could not be loaded	Antenna failed to start up normally.	Reboot the terminal. Contact your distributor if the problem persists.
08030	Antenna could not enter main application mode	Antenna failed to start up normally.	Reboot the terminal. Contact your distributor if the problem persists.

ID	Event Text	Explanation	Remedy
08031	Failed to enter normal operation	Antenna failed to start up normally.	Reboot the terminal. Contact your distributor if the problem persists.
08032	Firmware image version lower than active antenna version	The firmware in the antenna is newer than expected by the terminal.	Update the terminal software.
08033	Firmware image doesn't support antenna hardware	The antenna hardware version is not supported by the terminal.	Contact your distributor.
08034	Antenna failed to exit Flash Manager. Power cycle needed	New firmware was successfully uploaded to the antenna but the antenna failed to start normally with the new firmware.	Reboot the terminal. Contact your distributor if the problem persists.
08035	Unable to open port for HPA burst monitoring	There was an error communicating with the antenna.	Reboot the terminal. Contact your distributor if the problem persists.

ID	Event Text	Explanation	Remedy
08036	Radio silence is activated	The Radio silence function is activated. No transmission is allowed.	If the Radio silence function should not be active, enter the web interface and select SETTINGS > Discrete I/O . Then uncheck the Enabled box for Radio silence .

Logging of events

Diagnostic report

When contacting Thrane & Thrane for support, please include a diagnostic report.

The diagnostic report contains information relevant for the service personnel during troubleshooting.

To generate the diagnostic report, access the web interface and select **HELPDESK**. Then click **Generate report**.

Event log

The event log holds information of events registered in the terminal or antenna. The same events are also indicated in the Antenna and Terminal LEDs on the terminal LED panel.

The log includes the time of the occurrence, a short description, location of the error etc. This information can help troubleshooting errors in the system. You can see the event log in the web interface. For further information, see *Viewing the Event list or the Event log* on page 150.

Reset button

How to access the Reset button

The terminal has a Reset button placed next to the SIM slot behind the SIM cover. The functions of this button is described in the next section.

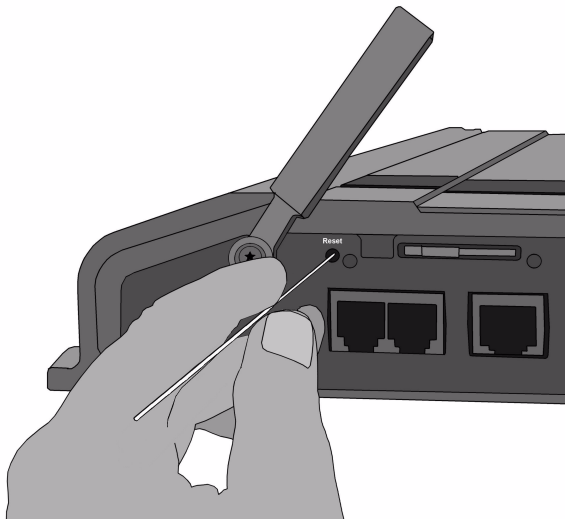

To press the Reset button, use a pointed device.

Function of the Reset button

The Reset button on the terminal has the following functions:

Action	Function
With the terminal running, press the Reset button normally.	<p>The terminal IP address and IP netmask are temporarily set to the default value (default IP address: 192.168.0.1).</p> <p>With this function, even if the IP address has been changed and you do not remember the new IP address, you can still access the web interface and see your current configuration. The default value is not saved in the configuration, but is only valid until next reboot.</p>
With the terminal running, press and hold the Reset button for 30 seconds, until the Power indicator on the terminal is flashing orange.	The terminal restores factory settings and reboots the system.
While the terminal is booting, press and hold the Reset button.	<p>For service use only!</p> <p>The bootloader initiates software upload.</p> <p>Refer to the installation manual for details.</p>

Conformity

SAILOR[®] 500 FleetBroadband

CE (R&TTE)

The SAILOR 500 FleetBroadband is CE certified (R&TTE directive) as stated in the “Declaration of Conformity with R&TTE Directive”, enclosed in copy on the next page.

Thrane & Thrane A/S

Declaration of Conformity with R&TTE Directive

The undersigned of this letter declares that the following equipment complies with the specifications of EC directive 1999/5/EC concerning Radio & Telecommunications Terminal Equipment.

Equipment included in this declaration

TT-3740A	SAILOR 500 FleetBroadband System:	
TT-3052A	SAILOR 500 FleetBroadband Antenna	PN = 403052A
TT-3738A	SAILOR FleetBroadband Terminal	PN = 403738A

Equipment Applicability

The SAILOR 500 FleetBroadband is a system that provides voice, fax or high speed data communication through the Inmarsat satellite service world wide between a ship and any destination in the world.

Declaration

The safety requirement with respect to the LVD directive 73/23/EC is met by conforming to the harmonized EU standard EN 60950. The protection requirement with respect to the EMC directive 89/336/EC is met by conforming to the harmonized EU standard EN 60945. Effective use of frequency spectrum is met by a conformity assessment by the National Telecom Agency, Denmark, Notified Body No. 0170, on the basis of the harmonized EU standard ETSI EN 301 444.

Manufacturer

Thrane & Thrane A/S Lundtoftegårdsvej 93D, DK-2800 Kgs. Lyngby, Denmark
 Porsvej 2, DK-9200 Aalborg SV, Denmark

Place and Date

Kgs. Lyngby, 15. November 2007



Lars Thrane, President
 Thrane & Thrane A/S



Doc. no. 99-126558.A

Page: 1 of 1



SAILOR[®] 250 FleetBroadband

CE (R&TTE)

The SAILOR 250 FleetBroadband is CE certified (R&TTE directive) as stated in “Declaration of Conformity with R&TTE Directive”, enclosed in copy on the next page.

Thrane & Thrane A/S

Declaration of Conformity with R&TTE Directive

The undersigned of this letter declares that the following equipment complies with the specifications of EC directive 1999/5/EC concerning Radio & Telecommunications Terminal Equipment.

Equipment included in this declaration

TT-3742A	SAILOR 250 FleetBroadband System:	
TT-3050A	SAILOR 250 FleetBroadband Antenna	PN = 403050A
TT-3738A	SAILOR FleetBroadband Terminal	PN = 403738A

Equipment Applicability

The SAILOR 250 FleetBroadband is a system that provides voice, fax or high speed data communication through the Inmarsat satellite service world wide between a ship and any destination in the world.

Declaration

The safety requirement with respect to the LVD directive 73/23/EC is met by conforming to the harmonized EU standard EN 60950. The protection requirement with respect to the EMC directive 89/336/EC is met by conforming to the harmonized EU standard EN 60945. Effective use of frequency spectrum is met by a conformity assessment by the National Telecom Agency, Denmark, Notified Body No. 0170, on the basis of the harmonized EU standard ETSI EN 301 444.

Manufacturer

Thrane & Thrane A/S Lundtoftegårdsvej 93D, DK-2800 Kgs. Lyngby, Denmark
Porsvej 2, DK-9200 Aalborg SV, Denmark

Place and Date

Kgs. Lyngby, 22. November 2007

Walther Thygesen, CEO
Thrane & Thrane A/S



Doc. no. 99-126559.A

Page: 1 of 1



A

APN Access Point Name. The Access Point Name is used by the terminal operator to establish the connection to the required destination network.

B

BGAN Broadband Global Area Network. A satellite network based on geostationary satellites, delivering data rates of up to 492 kbps to virtually any part of the earth, with full UMTS (3G) compatibility.

C

CE Conformité Européenne. This term signifies that a CE certified product conforms to European health, environmental, and safety regulations. In short, it makes the product legal to be sold in the European Union.

CID Context Identifier

CM Continuous Monitoring

CS Circuit-Switched. Circuit-switched networks require dedicated point-to-point connections during calls.

D

DHCP Dynamic Host Configuration Protocol. A protocol for assigning dynamic IP addresses to devices on a network. With dynamic addressing, a device can have a different IP address every time it connects to the network.

DNS Domain Name System. A system translating server names (URLs) to server addresses.

G

Geostationary	Placed in a fixed position relative to a point on the surface of the earth.
GPRS	General Packet Radio Service. A standard for wireless communications which runs at speeds up to 115 kbps, compared with current GSM (Global System for Mobile Communications) systems' 9.6 kbps.
GPS	Global Positioning System

H

HPA	High Power Amplifier
-----	----------------------

I

I/O	Input/Output
IMEI	International Mobile Equipment Identity. A unique number identifying your terminal
IMSO	International Maritime Satellite Organisation. An intergovernmental body established to ensure that Inmarsat continues to meet its public service obligations, including obligations relating to the GMDSS.
IP	Internet Protocol
ISDN	Integrated Services Digital Network. A circuit-switched telephone network system, designed to allow digital transmission of voice and data over ordinary telephone copper wires, resulting in higher quality and speed than are available with analog.

K

kbps	kilobits per second
------	---------------------

L

LAN Local Area Network

LED Light Emitting Diode

M

MAC Media Access Control.

MSN Multiple Subscriber Numbering. In most pieces of ISDN equipment you can program multiple subscriber numbers. The number programmed into the equipment should be the dial-in number that you wish that piece of equipment to answer.

N

NAT Network Address Translation. An Internet standard that enables a local-area network to use one set of IP addresses for internal traffic and a second set of addresses for external traffic. A NAT module makes all necessary address translations.

P

PDP Packet Data Protocol. A network protocol used by external packet data networks that communicate with a GPRS network.

PIN Personal Identification Number. A code number used to provide access to a system that has restricted access.

PoE Power over Ethernet

POR Pacific Ocean Region

POST Power On Self Test. A test sequence that runs every time the system is powered up or reset.

PS Packet-Switched. Packet-switched networks move data in separate, small blocks (packets) based on the destination address in each packet.

PUK PIN Unblocking Key. An eight-digit code used to unblock a SIM card after three incorrect PINs have been entered. The PUK code is supplied with the SIM card.

Q

QoS Quality of Service

R

RDI Restricted Digital Information

RF Radio Frequency. Electromagnetic wave frequencies between about 3 kilohertz and about 300 gigahertz including the frequencies used for communications signals (radio, television, cell-phone and satellite transmissions) or radar signals.

S

SAS Satellite Access Station. The gateway between the satellites and the worldwide networks such as Internet, telephone network, cellular network etc.

SDU Service Data Unit. Also known as a data packet.

SIM Subscriber Identity Module. The SIM provides secure storing of the key identifying a mobile phone service subscriber but also subscription information, preferences and storage of text messages.

SMS Short Messaging Service

Streaming A technique for transferring data - such as audio or video clips - so that it is processed as a continuous stream. With a Streaming connection you are charged by the minute, like for a telephone connection.

T

TCP Transmission Control Protocol. One of the core protocols of the Internet protocol suite. TCP provides reliable, in-order delivery of a stream of bytes, making it suitable for applications like file transfer and e-mail.

U

UDI Unrestricted Digital Information

V

VPN Virtual Private Network. A network that is constructed by using public wires to connect nodes. You can create networks using the Internet for transporting data, using security mechanisms so that only authorized users can access the network.

Numerics

- 2-wire interface
 - local numbers, 45
 - setting call type, 91

A

- administration settings, 133
- analog phone
 - local numbers, 45
- antenna
 - viewing properties, 86
 - viewing status, 66
 - viewing type, 66
- APN, common setting, 95
- audio quality, 39

B

- barring calls, 99
- BGAN
 - connecting to, 30
 - coverage, 12
 - services, 14
 - system overview, 13
- browser settings
 - for web interface, 58

C

- call log, 76
- call type, 39
 - setting for IP handsets, 108
 - setting for ISDN, 92
 - setting for Phone/Fax interface, 91

calls

- barring, 99
- closed user group, 102
- forwarding, 98
- holding, 48
- line identification, 101
- local, 46
- making or receiving, 42
- missed, received, outgoing, 77
- redial, 45
- to the terminal, 44
- transferring, 49
- viewing ongoing, 70
- waiting indication, 47, 100
- CE compliance, 185
- clearing logs, 138
- clearing usage counter, 138
- closed user group, 102
- common network settings, 95
- computer, connecting to LAN, 25
- configuration
 - exporting to file, 136
 - importing from file, 136
 - ISDN, 92
 - LAN, 87
- conformity, 185
- connecting to the BGAN network, 30
- connector panel, 20
- contact information, 153
- coverage
 - Inmarsat BGAN system, 12

D

- dashboard, 65

- data
 - profiles, 139
 - traffic flow filters, 143
- data sessions
 - viewing ongoing, 70
- Declarations of Conformity, 186, 188
- dialing prefixes, 46
- document number
 - installation manual, vii
 - IP handset manual, vii
 - this manual, i

E

- Ethernet interface
 - setting up, 87
- events
 - in LED panel, 170
 - list of active, 150
- exporting configuration, 136

F

- fax, sending or receiving, 50
- features overview, 3
- forwarding calls, 98

H

- help desk number, 148
 - changing in web interface, 148
- holding a call, 48

I

- ignition function, 22
- IMEI number, 66

- importing configuration, 136
- Inbox for SMS messages
 - replying, forwarding or deleting, 83
- indicator functions, 166
- installation manual
 - document number, vii
- interfaces and services
 - combinations, 17
- internal calls, 46
- Internet connection, 25
- IP address
 - external, setting up, 116
 - for connected device, 119
 - for web interface, 60
 - local, setting up, 88
 - local, viewing, 66
- IP handset
 - BGAN features, 36
 - connecting, 24
 - description, 9
 - entering PIN, 26
 - local numbers, 45
 - manual, vii
 - setting call type, 108
 - setting up, 104
 - starting up, 24
- ISDN interface
 - local numbers, 45
 - setting up, 92

L

- LAN
 - connecting a computer, 25
 - managing network users, 111
 - setting up interface, 87
- L-Band interface
 - enabling or disabling, 86

LED functions, 166
light indicator functions, 166
limitations in services, 16
line identification, 101
local numbers assigned, 45
local phone call, 46
logs, clearing, 138

M

MAC address, 66
manual
 document number, i
matrix of services and interfaces, 17
messages
 configuring outgoing, 84
 forwarding, 83
 opening in web interface, 83
 receiving in web interface, 82
 replying, 83
 sending, 81
microwave radiation, iii
mobile numbers
 viewing and editing, 75

N

navigation in web interface, 62
network management, 111
network terms
 definitions, 124

O

Outbox for SMS messages
 resending or deleting messages, 80

P

phone
 local call, 46
 making calls, 42
phone book, 71
 adding number, 74
 deleting all entries, 74
 deleting an entry, 74
 modifying an entry, 74
phone numbers for terminal, 75
Phone/Fax interface
 local numbers, 45
 setting call type, 91
PIN
 administration PIN, 133
 entering, 26
 entering in web interface, 63
 entering with a phone, 26
 entering with IP handset, 26
port forwarding, 89
powering the terminal, 21
prefixes, special-purpose, 46
profiles for data transmission, 139
properties
 antenna, 86
 system, 66
Proxy server, disabling, 58
PUK code, 27, 29, 63

Q

quality of voice, 39
Quick dial, 42

R

radiation, iii

redial, 45
registering on the BGAN network, 30
remote on/off, 22

S

safety summary, iii
satellite
 selecting, 131
 view selected, 66
sent messages
 resending, forwarding or deleting, 81
 viewing status, 81
serial number, 66
services
 limitations, 16
 supplementary, 92
 supported by BGAN, 14
services and interfaces
 combinations, 17
Short dial, 42
show number, 101
SIM lock, 16
SMS in web interface
 forwarding, 83
 opening, 83
 receiving, 82
 replying to, 83
 sending, 81
SMS service number, 85
software
 uploading, 126
 viewing version, 66
spare parts, 156
Standard data, 52
 activating, 54, 69
 definition, 52

status
 methods for signaling, 165
 ongoing calls and data sessions, 70
 viewing, 65
Streaming data, 52
 activating, 53
 definition, 52
supplementary services
 setting up, 92
 supported, 15
 using, 47
support
 contact information, 153

T

telephone interface
 local numbers, 45
 setting call type, 91
tools for setting up the terminal, 35
total usage
 viewing, 70, 76
traffic flow filters, 143
transferring a call, 49
troubleshooting guide, 159
typography used in this manual, viii

U

uploading software, 126
usage counter, 70, 76
 clearing, 138
user interfaces, 35

V

version of software, 66

- voice mail number
 - viewing, 85
- voice quality, 39
 - setting for IP handsets, 108
 - setting for ISDN, 92
 - setting for Phone/Fax interface, 91

W

- waiting calls, 47, 100
- web interface
 - accessing, 57
 - browser settings, 58
 - definition, 57
 - navigating, 62

