



# Explorer 550/550i





## Chartplotter

Installation and Operation Manual

# **NORTHSTAR**

[www.northstarnav.com](http://www.northstarnav.com)

**IMPORTANT SAFETY INFORMATION**  
**Please read carefully before installation and use.**

	This is the safety alert symbol. It is used to alert you to potential personal injury hazards, Obey all safety messages that follow this symbol to avoid possible injury or death.
	WARNING indicates a potentially hazardous situation which, if not avoided, could result in death or serious injury
	CAUTION indicates a potentially hazardous situation which, if not avoided, could result in minor or moderate injury.
	CAUTION used without the safety alert symbol indicates a potentially hazardous situation which, if not avoided, may result in property damage.

**DISCLAIMER:** It is the owner's sole responsibility to install and use the instrument and transducers in a manner that will not cause accidents, personal injury or property damage. The user of this product is solely responsible for observing safe boating practices.

BRUNSWICK NEW TECHNOLOGIES INC. AND ITS SUBSIDIARIES AND AFFILIATES DISCLAIM ALL LIABILITY FOR ANY USE OF THIS PRODUCT IN A WAY THAT MAY CAUSE ACCIDENTS, DAMAGE OR THAT MAY VIOLATE THE LAW.

Governing Language: This statement, any instruction manuals, user guides and other

information relating to the product (Documentation) may be translated to, or has been translated from, another language (Translation). In the event of any conflict between any Translation of the Documentation, the English language version of the Documentation will be the official version of the Documentation.

This manual represents the Explorer 550/550i as at the time of printing. Brunswick New Technologies Inc. and its subsidiaries and affiliates reserve the right to make changes to specifications without notice.

Copyright © 2006 Brunswick New Technologies Inc. Northstar™ is a registered trademark of Brunswick New Technologies Inc

#### **FCC Statement**

Note: This equipment has been tested and found to comply with the limits for a Class B digital device, pursuant to Part 15 of the FCC Rules. These limits are designed to provide reasonable protection against harmful interference in a normal installation. This equipment generates, uses and can radiate radio frequency energy and, if not installed and used in accordance with the instructions, may cause harmful interference to radio communications. However, there is no guarantee that interference will not occur in a particular installation. If this equipment does cause harmful interference to radio or television reception, which can be determined by turning the equipment off and on, the user is encouraged to try to correct the interference by one or more of the following measures:

- Reorient or relocate the receiving antenna.
- Increase the separation between the equipment and receiver.
- Connect the equipment into an output on a circuit different from that to which the receiver is connected.
- Consult the dealer or an experienced technician for help.
- A shielded cable must be used when connecting a peripheral to the serial ports.

## **Important**

---

It is your sole responsibility to install and use Northstar's instrument and GPS antenna in a manner that will not cause accidents, personal injury or property damage. Always observe safe boating practices.

The choice, location, angle and installation of the instrument & GPS antenna are critical to performance of the system as intended. Follow instructions in this manual carefully. If in doubt, consult your Northstar dealer.

Ensure that any holes cut are in a safe position and will not weaken the boat's structure. If in doubt, consult a qualified boat builder.

**Global Position System:** The global Position System (GPS) is operated by the U.S. Government which is solely responsible for its operation, accuracy and maintenance. The GPS is subject to changes which could affect the accuracy and performance of all GPS equipment anywhere in the world, including the Explorer. To reduce the risk of misusing or misinterpreting the Explorer, you must read and understand all aspects of this Installation & Operation Manual. We also recommend that you practice all operations using the built-in simulator before using the Explorer.

**Electronic Chart:** The electronic chart used by Explorer is an aid to navigation designed to supplement, not replace official government charts. Only official government charts supplemented by notices to mariners contain the information required for safe and prudent navigation. Always supplement the electronic information provided by Explorer with other plotting sources such as observations, depth soundings, radar and hand compass bearings. Should the information not agree, the discrepancy must be resolved before proceeding any further.

**Fuel Computer:** Do not rely on the fuel computer as the sole source of information regarding available fuel onboard. Fuel economy can change drastically depending on boat loading and sea conditions. Fuel Computer information should be supplemented by visual or other checks of the fuel load. This is necessary due to possible operator errors such as forgetting to reset the fuel used when filling the tank, running the engine with the Fuel Computer not switched on, or on other operator actions that may render the device inaccurate. Always carry adequate fuel onboard for the intended trip, plus a reserve to allow for unforeseen circumstances.

**Failure to adhere to these warnings may lead to death, serious injury or property damage.**

**Northstar disclaims all liability for installation or use of this product that causes or contributes to death, injury or property damage or that violates any law.**

As Northstar is continuously improving this product we retain the right to make changes to the product at any time which may not be reflected in this version of the manual. Please contact your nearest Northstar office if you require any further assistance.

### **Industry Canada**

Operation is subject to the following two conditions: (1) this device may not cause interference, and (2) this device must accept any interference, including interference that may cause undesired operation of the device.

The Explorer is set up with default units. To change the units, see section 14-8

# Contents

---

<b>1 Introduction .....</b>	<b>7</b>
1-1 Overview .....	7
1-2 Cleaning and maintenance .....	7
1-3 Plug-in cards .....	7
1-4 Removing and replacing the display unit .....	8
<b>2 Basic Operation.....</b>	<b>9</b>
2-1 Using the keys .....	9
2-2 Using the menus.....	10
2-3 Turning on and off / auto power .....	10
2-4 Backlight and night mode .....	11
2-5 Man overboard (MOB) .....	11
2-6 Alarms .....	11
2-7 Simulate mode.....	12
2-8 The main displays.....	12
<b>3 Navigation: Chart.....</b>	<b>16</b>
3-1 Overview of navigating .....	16
3-2 Chart display .....	18
3-3 Distance and bearing calculator .....	20
3-4 Projected course.....	21
3-5 Tracks and tracking .....	21
<b>4 Navigation: Highway display.....</b>	<b>22</b>
<b>5 Navigation: Waypoints.....</b>	<b>22</b>
5-1 Waypoints display.....	23
5-2 Managing waypoints .....	23
<b>6 Navigation: Routes .....</b>	<b>25</b>
6-1 Routes display .....	25
6-2 Managing routes .....	26
<b>7 Satellites .....</b>	<b>28</b>
7-1 Satellite display.....	29
<b>8 Gauges display.....</b>	<b>29</b>
<b>9 Data display.....</b>	<b>30</b>

<b>10 Fuel functions and display .....</b>	<b>31</b>
10-1 What the fuel computer does .....	31
10-2 Fuel display .....	31
10-3 When you add or remove fuel .....	32
10-4 Low fuel alarm .....	33
10-5 Boat speed sensors .....	33
10-6 Fuel consumption curves .....	35
10-7 Calibration .....	37
<b>11 Tides display .....</b>	<b>38</b>
<b>12 User card display .....</b>	<b>39</b>
<b>13 About display .....</b>	<b>40</b>
<b>14 Setting up the EXPLORER 550/550i .....</b>	<b>41</b>
14-1 Setup > System .....	41
14-2 Setup > Chart .....	43
14-3 Setup > GPS .....	46
14-4 Setup > Fuel .....	47
14-5 Setup > Track .....	48
14-6 Setup > Logs .....	49
14-7 Setup > Alarms .....	49
14-8 Setup > Units .....	50
14-9 Setup > Comms .....	50
14-10 Setup > Time .....	51
14-11 Setup > Simulate .....	51
<b>15 Installation .....</b>	<b>52</b>
15-1 Installation: What comes with the EXPLORER 550/550i .....	52
15-2 Installation: Options and Accessories .....	52
15-3 Installation: The display unit .....	54
15-4 Installation: Power/Data cable .....	55
15-5 Installation: GPS antenna .....	56
15-6 Installation: Northstar petrol/gasoline sensors .....	56
15-7 Installation: SmartCraft .....	57
15-8 Installation: Other NavBus instruments .....	57
15-9 Installation: Other NMEA instruments .....	58
15-10 Installation: Setup and test .....	59

Appendix A - Specifications .....	60
Appendix B - Troubleshooting.....	62
Appendix C - Glossary and navigation data.....	65

## Quick reference

Feature	Type	See	Requires
<b>General</b>	How to use the keys and displays	2	
	Troubleshooting	Appendix B	
	Simulate mode	2-7	
	Glossary of special names	Appendix C	
	Specifications	Appendix A	
<b>MOB</b>	Man overboard key	2-5	
<b>Navigation</b>	Overview of how to navigate	3-1	GPS fix
	Finding the boat's position on the chart	3-2	
	Navigate to any point or to a waypoint	3-1	
	Navigate along a route	3-1	
	Projected course: An estimate of progress	3-4	
	Tracks: records of where the boat has been	3-5	
	GPS receiver status	7	
Saving and loading data with a user card	12	User card	
<b>Chart data</b>	Chart features (built in world chart)	3-2	
	Chart details	3-2-4 & 5	C-MAP™ chart
	Tides at a port	11	C-MAP™ chart
<b>Alarms</b>	Built in alarms	2-6	
	SmartCraft engine alarms	1-1	SmartCraft
<b>Boat data</b>	Data at top of main displays	2-8-2	
	Compass at top of main displays	2-8-3	
	Dedicated data display	9	
<b>Fuel</b>	Fuel computer, petrol/gasoline engine	10	Fuel sensors
	Fuel computer, SmartCraft engines	10	SmartCraft
	What to do when you add or remove fuel	10-3	

# 1 Introduction

---

## 1-1 Overview

---

The Northstar EXPLORER is a compact, rugged, highly integrated marine chartplotter. It is easy to use and has an easy to read color display. Complex functions can be performed with a few key presses, taking the hard work out of boating.

This manual covers:

### EXPLORER 550

Color display, external GPS antenna.

### EXPLORER 550i

Color display, internal GPS antenna.

The available functions, displays and setup menus depend on the optional sensors and instruments that are installed:

- The Fuel functions require optional petrol/gasoline or SmartCraft fuel sensors to be installed and set up.

- SmartCraft engine functions require a SmartCraft system to be installed. For information on using SmartCraft, see the *SmartCraft Gateway Installation and Operation Manual*.
- The EXPLORER can send data to other instruments, such as an autopilot, and receive data from other instruments.

For information on installing options, see section 15-2.

This manual describes how to install and operate the EXPLORER. Special terms are explained in Appendix C. For maximum benefit, please read this manual carefully before installing and using the unit. For more information on this instrument and other Northstar products, go to our website, [www.northstarnav.com](http://www.northstarnav.com).

## 1-2 Cleaning and maintenance

---

The EXPLORER screen is covered by a proprietary anti-reflection coating. To avoid damage, clean the screen only with a damp cloth and mild detergent when dirty or covered in sea salt. Avoid abrasive cleaners, petrol or other solvents. If a plug-in card gets dirty or wet, clean it with a damp cloth or mild detergent.

To optimize performance, avoid walking on or jamming cables and connectors.

Push the dust cover over the display when the EXPLORER is turned off.

## 1-3 Plug-in cards

---

The EXPLORER can use two kinds of plug-in card:

- **C-MAP™ chart cards** have chart details required for navigating in a particular region. When a chart card is plugged in, the extra details automatically appear on the EXPLORER chart display.

The EXPLORER can use NT, NT+ and NT-MAX cards.

- **C-MAP™ user cards** are used to store navigation data. Each user card expands the EXPLORER memory and allows the data to be transferred to another EXPLORER easily (see section 14).

**Note:** The older 5 volt user cards are not supported.

## Changing the plug-in card

### CAUTION

Handle plug-in cards carefully. Keep them in their protective cases when not plugged into the EXPLORER.

Keep the holder in place in the EXPLORER at all times to prevent moisture from entering the card compartment.

Gold contacts under here

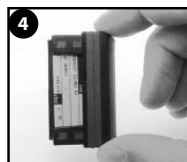
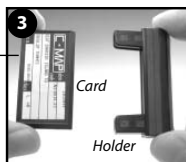

- Turn the EXPLORER off (see section 2-2).
- Pull the card holder out of the EXPLORER and pull any card out of holder.
- Put the card in its case.

Push new card into holder. Ensure the gold contacts are on the outer edge and underneath (see above).

Keep the card's case.

Push card holder fully into EXPLORER

## 1-4 Removing and replacing the display unit

If the display unit is bracket mounted then the display unit can easily be removed and replaced for security or protection.

### Removing the display unit:

- Turn the display unit off (see section 2-3) and put the dust cover on.
- Loosen the knob on the mounting bracket and lift the unit off the bracket.
- Unplug the connectors from from the display unit, turning each locking collar anticlockwise. Push the attached dust covers over the connectors.
- Store the display unit in a dry clean place, such as the optional Northstar carry bag.

### Replacing the display unit

- Remove the dust covers from the connectors. Plug the connectors into the back of the display unit:
  - Match the connector's color to the socket color.
  - Insert each connector and turn the locking collar clockwise until it is finger tight.



- Nothing will be damaged if a cable is plugged into the wrong socket by mistake.
- Hold the display unit in place on the mounting bracket. Adjust the tilt of the display for best viewing, then hand tighten the knob on the mounting bracket. Remove the dust cover.



## 2 Basic Operation

---

### Overview of the keys

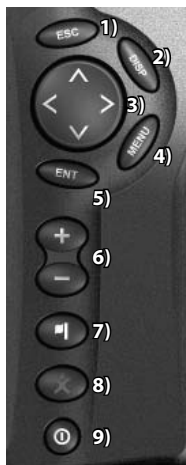

- 1) Go back to an earlier menu or display. Any changes made are ignored. In chart mode, centres chart at boat's position.
- 2) Show a menu of the main displays. To go to a display, select it from the menu (see section 2-8).
- 3) Cursor keys, to move the cursor or the selection highlight.
- 4) Show a menu of the options for the current display.  
Press **MENU** again to display the Setup menu (see section 14).
- 5) Start an action or accept a change.
- 6) Zoom in or out to display different areas and detail on the chart.
- 7) Create an instant waypoint at the boat position (see section 5-2-1).
- 8) Man overboard (MOB, see section 2-5).
- 9) Turn EXPLORER on and off (see section 2-3); adjust the backlighting (see section 2-4).

### 2-1 Using the keys

---

In this manual:

**Press** means to push the key for less than a second.

**Hold** means to hold the key down.

The internal beeper beeps when a key is pressed (to disable or enable the beep, see section 14-1).

## 2-2 Using the menus

Operate the EXPLORER by selecting items from menus. Items can be submenus, commands or data.

### Selecting a submenu

A ► after a menu item indicates a submenu, for example **Chart ►**. Press ▲ or ▼ to move the highlight to the submenu, then press ENT.

### Starting a command

Press ▲ or ▼ to move the highlight to the command, for example **Goto cursor**, then press ENT.

### Changing data

First press ▲ or ▼ to move the highlight to the data to change, then:

a) To change a tick box

means On or Yes

means Off or No.

Press ENT or ► to change the tick box.

b) To select an option

1 Press ENT to display the menu of options.

2 Press ▲ or ▼ to move the highlight to the option you want, then press ENT.



### c) To change a name or number:

1 Press ENT to display the name or number:

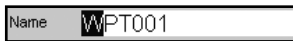

2 Press ◀ or ▶ to select a letter or digit to change. Press ▲ or ▼ to change the letter or digit.

Repeat this to change other letters or numbers.

3 Press ENT to accept the new value. Or press ESC to ignore the changes.

### d) To change a slider value

Press ◀ to decrease the value or ▶ to increase the value.



## 2-3 Turning on and off / auto power

### Turning on manually

If the EXPLORER is not wired for auto power, press **ⓘ** to turn the unit on. If necessary, adjust the display to be easy to read (see section 2-4).

**Note:** If the EXPLORER is not wired for auto power then the EXPLORER does not record engine hours and might not record fuel consumption (see section 15-4).

### Turning off manually



If the EXPLORER is not wired for auto power or if the ignition switch is off, hold down **ⓘ** until the display turns off.

### Auto power



If the EXPLORER is wired for auto power (see section 15-4), then:



- The EXPLORER automatically turns on when you turn the boat's ignition switch on.
- You can not turn the EXPLORER off while the ignition switch is on.
- If **Auto power off** (see section 14-1) is , the EXPLORER automatically turns off when you turn the boat's ignition switch off.
- If **Auto power off** (see section 14-1) is , the EXPLORER stays on when you turn the boat's ignition switch off. You can now turn the EXPLORER off manually.

## 2-4 Backlight and night mode

To go to the Backlight display, press  briefly. When you have finished, press .

### Backlight

The display and keys are backlit. To change the backlight level, select **Backlight**, then press  to dim or  to brighten.

 **Tip:** Press  twice to give the brightest screen, with maximum backlight and Night mode off.

## 2-5 Man overboard (MOB)

The MOB feature saves the boat's position and then navigates back to this point.

### **WARNING**

MOB will not work if the EXPLORER does not have a GPS fix.

- 1 Press .  
The EXPLORER stores the boat's position as a waypoint called MOB.
- 2 The EXPLORER changes to the chart display, with the MOB waypoint at the centre of the chart.  
The chart zooms in for accurate navigation. If the chart can not show the required small scale, the EXPLORER changes to plotter mode (a white display with crosshatching and no chart details, see section 14-2).
- 3 The EXPLORER sets the MOB waypoint to be the destination to navigate to.

**If the NMEA output (autopilot) is off** (see section 14-9) use the EXPLORER to manually navigate to the destination MOB waypoint (see sections 3-1-1 and 3-1-2).

 **Tip:** The MOB waypoint remains on the chart after the MOB has been cancelled. To delete the MOB waypoint, see section 5-2-5.

## 2-6 Alarms

When the EXPLORER detects an alarm condition, it displays a warning message on the display, the internal beeper sounds and any external beepers or lights operate.

### Night mode

Night mode sets the palette for all displays.

- Normal palette, for daytime
- A palette optimised for night time.

To change mode, select Night mode, then press . To change only the chart palette, see section 14-2.

### **If the NMEA output (autopilot) is on,**

the EXPLORER asks if the autopilot is active. Select:

**No :** Use the EXPLORER to manually navigate to the destination MOB waypoint (see sections 3-1-1 and 3-1-2).

**Yes :** The EXPLORER asks if the boat is to go to the MOB waypoint.

Select:

**Yes :** to immediately start navigating to the MOB waypoint.

### **WARNING**

This might result in a sudden and dangerous turn.

**No :** disengage the autopilot; then use the EXPLORER to manually navigate to the destination MOB waypoint (see sections 3-1-1 and 3-1-2).

### **To cancel MOB or set another MOB**

- 1 Press  again to display a menu.
- 2 Select an option from the menu.

Press  to clear the alarm. The alarm will sound again if the alarm condition occurs again. The EXPLORER has user settable alarms plus an alarm for loss of GPS fix (see section 14-7).

## 2-7 Simulate mode

In Simulate mode, the EXPLORER ignores data from the GPS antenna and other transducers and sensors and the EXPLORER generates this data itself. Otherwise, the EXPLORER functions normally.

### There are two simulate modes:

- **Normal**: Allows a user to become familiar with the EXPLORER off the water.

- **Demo**: Simulates a boat moving along a route and automatically displays different EXPLORER functions.

To start and stop Simulate mode, and for more information, see section 14-11. In simulate mode, Simulate or Demo flashes at the bottom of the display.

### **WARNING**

Never have Simulate mode on when the EXPLORER is navigating on the water.

## 2-8 The main displays

To go to a display, press **DISP**, press **◀** or **▶** to select the type of display to show, press **▲** or **▼** to select the display from the list, then press **ENT**.

The available displays depend on the optional sensors and instruments that are installed (see section 1-1).

### Chart menu and displays

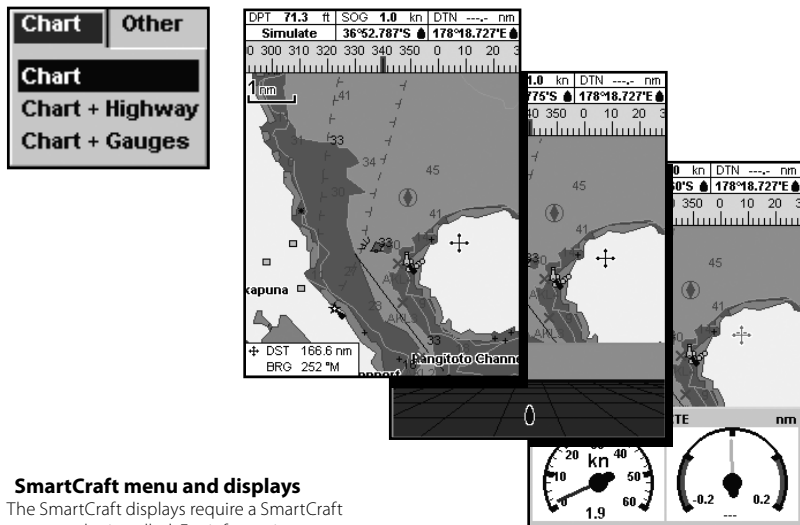

The screenshot displays the Chart menu and several chart displays. The menu on the left shows 'Chart' selected, with options 'Chart + Highway' and 'Chart + Gauges'. The main display shows a chart of the Kapuna area with various data fields: DPT 71.3 ft, SOG 1.0 kn, DTN --- nm, Simulate 36°52.787'S, 178°18.727'E, DST 166.6 nm, BRG 252 °M. Below the chart are two gauges: a speed gauge showing 1.9 kn and a depth gauge showing 0.2 nm.

### SmartCraft menu and displays

The SmartCraft displays require a SmartCraft system to be installed. For information on using SmartCraft, see the *SmartCraft Gateway Installation and Operation Manual*.



## 2-8-1 Dual displays

The EXPLORER can show two displays at once, for example Chart + Gauges. One of the displays, called the active display, has a yellow border and is controlled by the user. To change the active display, press **DISP** twice (Highway cannot be the active display). For example:

- If Chart is the active display: press **MENU** to display the options for Chart; press **DISP** twice to make Gauges the active display.
- If Gauges is the active display: press **MENU** to display the options for Gauges; press **DISP** twice to make Chart the active display.

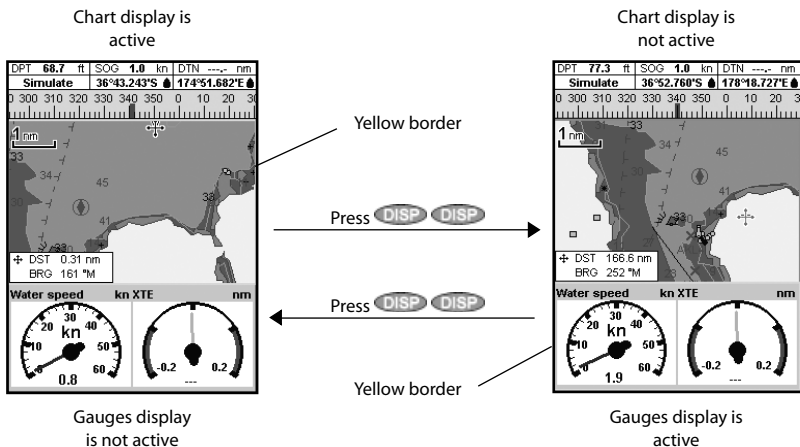

## 2-8-2 Data header

The chart and highway displays can show data at the top of the display.

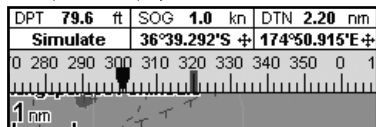

The data header for each display can be different. To change the data header for a display:

- 1 Go to the display, press **MENU** and select Data header.
- 2 To turn the data header **off** or **on**:
  - i Select Data.
  - ii Select  or .
- 3 To choose the size of the numbers:

- i Select Size.
  - ii Select Small, Medium or Large.
- 4 To change the data displayed:
    - i Select Data setup.
    - ii Change a data field:
      - a Press the cursor keys to highlight the field.
      - b Press **ENT** to display a menu of data items.
      - c Select a data item that is available on your system or select None to leave the field empty.
    - iii Repeat the above step to set the other data fields. Press **ESC**.

**Tip:** If less than the maximum number of lines of data are used, the data will take up less of the display area.

5 Press **ESC** to return to the display.

### 2-8-3 Compass

The chart and highway displays can show a compass at the top of the display.

The compass always shows the boat's course over ground (COG), a red symbol in the middle. When the boat is navigating to a point, the compass also shows bearing to the destination (BRG), a black symbol.

In this example, BRG is 300° and COG is 320°.

To turn the compass off or on:

- 1 Press **MENU** and select Data header.
- 2 Set Compass to  or .

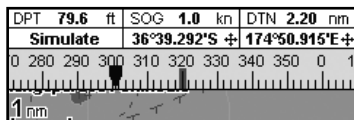

## 3 Navigation: Chart

The chart display shows the chart, the boat's position course and navigation data.

### 3-1 Overview of navigating

The EXPLORER has two ways of navigating, going straight to a point or following a route.

#### 3-1-1 Navigating to a point

When the EXPLORER is navigating to a point, the chart and highway displays show navigation data:

- A The boat position 
- B The destination point marked with a circle.
- C The boat's plotted course to the destination.
- D Two CDI lines, parallel to the boat's plotted course, which indicate the maximum expected deviation from the plotted course.

For more information, see appendix C.

If the EXPLORER is connected to an autopilot, the EXPLORER will send data to the autopilot to steer the boat to the destination. Start the autopilot before starting to navigate to the point.

If the EXPLORER has no autopilot, steer the boat manually:

- a use the boat position and destination on the chart or highway displays

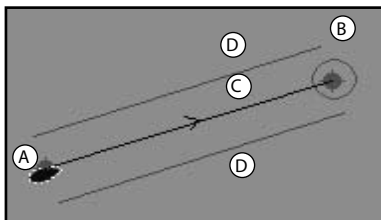

- b or use navigation data displayed on the data header (see section 2-8-2)
- c or use COG and BRG on the compass (see section 2-8-3).

#### Note:

- 1 If the XTE alarm is enabled, an alarm will sound if the boat deviates too much from its intended course (see section 14-7).
- 2 If the arrival radius alarm is enabled, then an alarm will sound to show that the boat has reached the destination (see section 14-7).



#### 3-1-2 Going to a waypoint or to a point on the chart

A waypoint is a position that you can set on the EXPLORER chart, for example a fishing spot or a point on a route (see section 5).

##### Going to a waypoint from the chart display

- 1 Go to the chart display.
- 2 Move the cursor to the waypoint: either use the cursor keys or use Find (see section 3-2-5).
- 3 Press **MENU** and select Got o.

##### Going to a waypoint from the waypoints display

- 1 Go to the waypoints display.
- 2 Press  or  to highlight the waypoint to go to.
- 3 Press **MENU** and select Got o.



## Going to a point on the chart

- 1 Switch to a chart display.
- 2 Move the cursor to the destination point: either use the cursor keys or use Find (see section 3-2-5).
- 3 Press **MENU** and select **Goto** cursor.

### **WARNING**

Make sure the course does not pass over land or dangerous waters.

 **Tip:** Before starting, create waypoints at points of interest. Create a waypoint at the start of the trip for you to navigate back to (see section 5-2-1).

## Navigating

The EXPLORER navigates to the point as described in section 3-1-1.

### Canceling navigating

Go to a Chart display, press **MENU** and select **Cancel goto**.

## 3-1-3 Following a route

### Preparing

A route is a list of waypoints that the boat can follow (see section 6).

- To create waypoints before creating the route, see section 5-2-1.
- To create a route, see section 6-2-1.

### Starting a route from the chart display:

- 1 Go to the chart display.
- 2 Press **MENU** and select **Start Route**.
- 3 Press **▲** or **▼** to highlight the route to follow. Press **ENT**.
- 4 The EXPLORER asks for the direction to traverse the route.  
Select **Forward** (the order the route was created) or **Reverse**.
- 5 The EXPLORER displays the chart with the route marked and starts navigating from the start of the route.

### Starting a route from the routes display:

- 1 Go to the routes display.
- 2 Press **▲** or **▼** to highlight the route to follow. Press **MENU** and select **Start**.
- 3 The EXPLORER asks for the direction to traverse the route.  
Select **Forward** (the order the route was created) or **Reverse**.

- 4 The EXPLORER displays a chart with the route marked and starts navigating from the start of the route.

### Navigating

The EXPLORER navigates to each waypoint on the route in turn as described in section 3-1-1.

The EXPLORER stops navigating to the waypoint at the end of the current leg and starts the next leg of the route:

- a when the boat comes within 0.025 nm of the waypoint
- b or when the boat passes the waypoint
- c or if you skip the waypoint.

### Skipping a waypoint

To skip a waypoint, go to a chart display, press **MENU** and select **Skip**. The EXPLORER starts navigating straight towards the next waypoint on the route.

### **WARNING**

Skipping a waypoint with the autopilot on might result in a sudden course change.

### Canceling a route

When the boat has reached the final waypoint, or to stop the boat following the route at any time, cancel the route. Go to a chart display, press **MENU** and select **Cancel route**.

### 3-2 Chart display

To go to the Chart display, press **DISP**, select **Chart**, then select **Chart**.

A typical chart display shows:

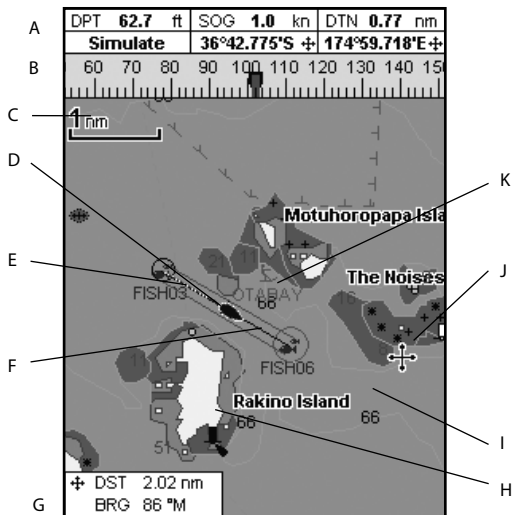

A	Data header. To turn the data off or on or to change what data is displayed, see section 2-8-2
B	Compass (see section 2-8-3)
C	Chart scale (see section 3-2-3)
D	Boat position (see section 3-2-1)
E	Boat track (see section 3-5)
F	Boat course and CDI lines (see Appendix C, CDI). The boat is going to the waypoint called FISH06
G	Distance and bearing of cursor from boat
H	Land
I	Sea
J	The cursor (see section 3-2-1)
K	A typical waypoint (see section 5)
<b>Note:</b> To change the types of information displayed on the chart, see section 17-2.	





### 3-2-1 Chart modes

#### The Chart has two modes:

##### Centre on boat mode

To switch to centre on boat mode in the chart display, press **ESC**. The boat  is at the centre of the chart. As the boat moves through the water, the chart automatically scrolls to keep the boat in the centre of the chart. The cursor (see below) is turned off.



##### Cursor mode

The keys , ,  and  are called cursor keys. To switch to cursor mode in the chart display, hold down a cursor key. The cursor  appears and moves away from the boat:

- Press the key which points in the direction that the cursor will move, for example press  to move the cursor down.

- Press midway between two of the cursor keys to make the cursor move diagonally.
- Hold a cursor key down to make the cursor move continuously across the display.

In Cursor mode:

- The distance (DST) and bearing (BRG) of the cursor from the boat are displayed at the bottom, left corner of the display.
- The chart does not scroll as the boat moves.
- If the cursor reaches the edge of the display, the chart will scroll.

For example, hold down  to move the cursor to the right side of the display and the chart will scroll to the left.

### 3-2-2 Latitude and longitude

Latitude and longitude can be displayed in the data header. The display is degrees and minutes to three decimal places, about 2 m (6 ft) resolution. Normally the position is the boat's position, and the latitude and longitude has a boat symbol to show this:

 36° 29.637' N or S Latitude

 175° 09.165' E or W Longitude

If the cursor has been moved in the last ten seconds, then the position is the cursor's position, and the latitude and longitude has a cursor symbol to show this:



 36° 29.841' N or S Latitude

 175° 09.012' E or W Longitude

#### **WARNING**

When reading the boat position, make sure the position is not the cursor position.

### 3-2-3 Chart scale

Press  to zoom in and display a smaller area of the chart in more detail. Press  to zoom out and display a bigger area in less detail.

The chart scale is displayed at the top left of the chart:



### 3-2-4 Chart symbols and information

The chart will show symbols, such as waypoints and chart symbols (for example buoys, beacons, wrecks and marinas). When the cursor is placed over a symbol for at least two seconds, a data window appears at the bottom left of the display with information about the symbol.

To see stored information about a point on the chart (for example, a chart symbol):

- 1 Move the cursor to that point on the chart.
- 2 Press **MENU** and select Chart info.
- 3 A menu of objects is displayed:
  - i Select an object to display.
  - ii Press **ESC** to return to the menu. Select other objects.
  - iii Finally, press **ESC** to return to the chart.

### 3-2-5 Finding a chart symbol

To find and display a chart symbol:

- 1 Press **MENU** and select Find.
- 2 Select the type of symbol: Waypoints, Routes, Ports by name, Ports & services, or Tide stations.
- 3 For Ports & services: select the type of service to find.  
For Ports by name: press **←**, **→**, **↑** or **↓** to enter a name or letters contained in the port name, then press **ENT**.
- 4 A list of items is displayed. If there are more items than will fit on the display, press **+** or **-** to page up and down.

For Ports by name: to search for a different port name, press **ESC**, change the name, then press **ENT**.

- 5 Select the item and press **ENT**. The chart display changes to show the item in the middle of the display.

To see stored information about the item, press **ENT** (see section 3-2-4).

### 3-2-6 Perspective view

Perspective view shows the chart from an angle instead of from straight above. To turn perspective view on or off, press **MENU** and select Perspective to **✓** or **┐**.

### 3-3 Distance and bearing calculator

The distance and bearing calculator can plot a course of one or several legs and show the bearing and length of each leg, as well as the total distance along the course. The completed course can be converted into a route.

To use the distance and bearing calculator:

- 1 Press **ESC** until the chart display is displayed. Press **MENU** and select **Distance**.
- 2 Move the cursor to the start of the first leg. It does not matter if this point is a waypoint or not. Press **ENT**.
- 3 To add a leg to the course, move the cursor to the end of the leg. It does not matter if this point is a waypoint or not. The display shows the bearing and length of the leg, as well as the total distance along the course. Press **ENT**.

- 4 To remove the last leg from the course, press **MENU** and select **Remove**.
- 5 Repeat the above two steps to enter the whole course.
- 6 To save the new course as a route, press **MENU** and select **Save**. This also saves any new points on the course as new waypoints, with default names. If necessary, edit the route later (see section 6-2-2) and edit any new waypoints later (see section 5-2-3).
- 7 Finally, press **ESC** to return to the chart display.

### 3-4 Projected course

If Projected course is turned on, then the EXPLORER will display the projected position based on the course over ground (COG), speed and a specified time. To turn Projected course on and off and to set the time, see section 14-2.

- A Projected position
- B Boat's projected course
- C Boat position

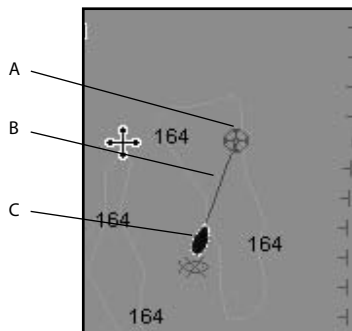

### 3-5 Tracks and tracking

Tracking records the boat's position to memory at regular intervals, which can be:

- Time intervals.
- Or distance intervals.

The track of where the boat has been can be displayed on the chart. The EXPLORER can display one track while recording another.

To work with tracks, see section 14-5.

The EXPLORER can store five tracks:

- Track 1 can hold up to 2000 points and is intended to record the normal progress of the boat.
- Tracks 2, 3, 4 and 5 can hold up to 500 points each and are intended to record sections to be retraced accurately, for example entering a river mouth.

**Tip:** Record the tracks in good conditions.

When recording is on and the track becomes full then recording continues and the oldest points in the track are deleted. The maximum length of a track depends on the selected track interval: a small interval will give a shorter, more detailed

track and a long interval will give a longer, less detailed track, as shown in these examples:

The track lengths are in the current distance units, for example nm.

Time intervals		
Interval	Track 1	Track 2, 3, 4 or 5
1 sec	33 minutes	8 minutes
10 sec	5.5 hours	1.4 hours
1 min	33 hours	8 hours
Distance intervals		
Interval	Track 1	Track 2, 3, 4 or 5
0.01	20	5
1	2,000	500
10	20,000	5,000

## 4 Navigation: Highway display

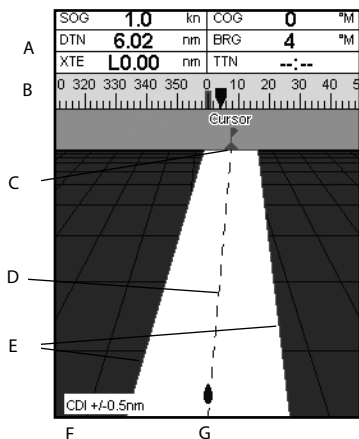

The highway display has a bird's eye view of the boat's course to a destination. To go to the Highway display, press **DISP**, select **Other**, then select **Highway**.

### The highway display shows:

- A Optional data header (see section 2-8-3)
- B Optional compass (see section 2-8-4)
- C Destination waypoint
- D Boat's plotted course to destination
- E CDI lines, parallel to the boat's plotted course (see Appendix C, CDI). The CDI lines are like a highway over the water where the boat will move.
- F CDI scale
- G The boat position is at the bottom, centre of the display.



The highway display does not show land, dangerous waters or chart symbols.

## 5 Navigation: Waypoints

A waypoint is a position that you can set on the EXPLORER chart for example a fishing spot or a point on a route. The EXPLORER can have up to 3000 waypoints. A waypoint can be created, changed or deleted. A waypoint has:

- A name (up to eight characters).
- An icon showing what kind of waypoint it is. The available icons are:

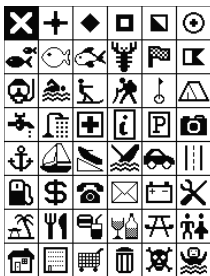

- A position.
- A color for the waypoint symbol and name on the chart.

- A type:
    - Normal:** A normal waypoint can be navigated to or included in a route.
    - Danger:** A danger waypoint is a point to avoid. If the boat comes within the danger radius of a danger waypoint the unit can sound an alarm (see section 14-7).
  - A display option:
    - Controls** how the waypoint is displayed when the **Waypoints** setup option is set to **Selected** (see section 14-2):
      - Off:** The waypoint is not displayed.
      - Icon:** The waypoint icon is displayed.
      - I+N (Icon and Name):** The waypoint icon and name are displayed.
- If there are many waypoints, use this feature to select which waypoints are displayed on the chart.

**Note:** The other choices for **Waypoints** are **Hide all** and **Show all** (see section 14-2).

## 5-1 Waypoints display

To go to the waypoints display, press

**DISP**, select Other, then select Waypoints.

The waypoints display is a list of the waypoints that have been entered, each with waypoint symbol, name, latitude and longitude, distance and bearing from the boat, type and display option.

If there are more waypoints than will fit on the display, press **+** or **-** to scroll up or down a page at a time.

Waypoints			
▼ Name	Latitude	DST(nm)	Dnrg
	Longitude	BRG(°M)	Disp
✕ AKL0	36°50.338'S 174°46.495'E	7.97 192	No I+N
✕ AKL1	36°49.945'S 174°49.021'E	6.75 179	No I+N
✕ AKL2	36°49.079'S 174°49.695'E	5.77 177	No I+N
✕ AKL3	36°47.849'S 174°49.200'E	4.75 185	No I+N
✕ AKL4	36°46.974'S 174°49.081'E	4.02 192	No I+N
✕ AMS0	53°19.180'N 007°18.545'E	10331 282	No I+N
✕ AMS1	53°19.762'N 007°14.141'E	10335 282	No I+N
✕ AMS2	53°19.927'N 007°10.720'E	10337 282	No I+N
✕ AMS3	53°19.927'N 007°07.868'E	10339 282	No I+N

**+** to page up / down

## 5-2 Managing waypoints

### 5-2-1 Creating a new waypoint

#### Creating a new waypoint from any display

Press **+**. A new waypoint is created at the boat position with the default name and data. To change the default data, see section 5-2-3.

#### Creating and editing a new waypoint from the chart display

- 1 To create a waypoint at the boat position, press ESC to switch the chart to centre on boat mode (or press **1**, see above).

Or, to create a waypoint at a different point, move the cursor to that point on the chart.

- 2 Press **ENT**.
- 3 A new waypoint, with the default name and data is created.
- 4 Change the waypoint data if necessary (see section 5-2-7). Select Save.

#### Creating a new waypoint from the waypoints display

- 1 In the waypoints display, press **MENU** and select Create.
- 2 A new waypoint, with a default name and data, is created at the boat position.
- 3 Change the waypoint data if necessary (see section 5-2-7). Select Save.

**Note:** Waypoints can also be created when a route is created (see section 6-2-1).

#### **⚠ WARNING**

Do not create a navigation waypoint on land or in dangerous water.

### 5-2-2 Moving a waypoint

#### Moving a waypoint from the chart display

- 1 In the chart display, move the cursor to the waypoint to move.
- 2 Press **MENU** and select Move.
- 3 Move the cursor to the new position and press **ENT**.

#### Moving a waypoint from the waypoints display

To move a waypoint from the waypoints display, edit the waypoint (see section 5-2-3) and change the latitude and longitude.

### 5-2-3 Editing a waypoint

#### Editing a waypoint from the chart display

- 1 In the chart display, move the cursor to the waypoint to edit.
- 2 Press **MENU** and select **Edit**.
- 3 Change the waypoint data (see section 5-2-7). Select **Save**.

#### Editing a waypoint from the waypoints display

- 1 In the waypoints display, press **▲** or **▼** to highlight the waypoint to edit. Press **MENU** and select **Edit**.
- 2 Change the waypoint data (see section 5-2-7). Select **Save**.

### 5-2-4 Displaying a waypoint on the chart

This goes to the chart display, and shows the selected waypoint at the centre of the display.

- 1 In the waypoints display, press **▲** or **▼** to highlight the waypoint to display. Press **MENU** and select **Display**.

Or, in the Chart display, press **MENU**, select **Find**, then select **Waypoints**. Select a waypoint from the list.

- 2 The EXPLORER switches to the chart display, with the selected waypoint at the centre of the chart.

### 5-2-5 Deleting a waypoint

A waypoint can not be deleted if the boat is navigating to it or if the waypoint is used in more than one route. A waypoint that is used in one route can be deleted.

#### **⚠ WARNING**

When a waypoint is deleted from a route, check that the changed route does not cross land or dangerous waters.

#### Deleting a waypoint from the chart display

- 1 In the chart display, move the cursor to the waypoint to delete.
- 2 Press **MENU** and select **Delete**.
- 3 Select **Yes** to confirm.

#### Deleting a waypoint from the waypoints display

- 1 In the waypoints display, press **▲** or **▼** to highlight the waypoint to delete. Press **MENU** and select **Delete**.
- 2 Select **Yes** to confirm.

### 5-2-6 Deleting all waypoints

- 1 In the waypoints display and press **MENU** and select **Delete all**.
- 2 Select **Yes** to confirm.

### 5-2-7 Changing a waypoint's data

To change the waypoint data when it is displayed in a window:

- 1 Select the data to change.

Press **ENT**.

Use the cursor keys to change the data.

Press **ENT**.

- 2 If necessary, repeat the above step to change other data.
- 3 Select **Save**.



## 5-2-8 Sort Waypoints

To change how the waypoints list is displayed:

- 1 Press **MENU** and select **Sort by**.
- 2 Select how to display the list:  
Name: In alphabetical order by name.

Icon: Grouped by icon type.

Distance: In order of distance from the boat.

An arrow at the top of a column indicates how the waypoints are sorted.

## 5-2-9 Navigating to a waypoint

See section 3-1-2.

## 6 Navigation: Routes

A route is a list of waypoints that the boat can navigate along. Routes can be created, changed and deleted.

The EXPLORER can have up to 25 routes. Each route can have up to 50 waypoints.

A route can:

- Start and stop at the same waypoint.
- Include waypoints more than once.

The EXPLORER can navigate along a route in either direction. Waypoints on the route can be skipped.

Routes are a powerful feature when the EXPLORER is connected to an autopilot, allowing the vessel to be automatically guided along the route.



**WARNING**

Make sure that routes do not cross land or dangerous water.

## 6-1 Routes display

The routes display is a list of the routes that have been entered, each with route name, start waypoint, end waypoint, number of legs and total distance.

To go to the routes display, press **DISP**, select **Other**, then select **Routes**.

If there are more routes than will fit on the display, press **+** or **-** to scroll up or down a page at a time.

Routes			
Name	Start	End	Legs
			Dist
AKLDEMO	AKL0	AKL4	4 5.25 nm
AMSDEMO	AMS0	AMS3	3 6.45 nm
CAEDEMO	CAE0	CAE4	4 8.22 nm
CPTDEMO	CPT0	CPT4	4 11.1 nm
GOADEMO	GOA0	GOA4	4 4.93 nm
LRHDEMO	LRH0	LRH4	4 4.58 nm
OGLDEMO	OGL0	OGL5	5 5.05 nm
ROUTE01	WPT001	WPT004	3 843.1 nm
SFODEMO	SFO0	SFO5	5 3.10 nm

to page up / down

## 6-2 Managing routes



### **WARNING**





After creating or changing a route, display the route on the chart and check that it does not cross land or dangerous water.

### 6-2-1 Creating a new route

#### A. Creating a new route from the chart display









While creating the route:

- Press  or  to change the range; scroll the chart by moving the cursor to the edge of the chart.
- A data box at the bottom left of the display shows the route name and total distance. If the cursor is near a leg, it shows the length and bearing of the leg as well.
- The legs of a route must start and end at waypoints. If a leg does not start or end at an existing waypoint then a new waypoint will be created automatically (to change the new waypoint data, see section 5-2-7).
- You can not use a Danger waypoint in a route.

- 1 In the chart display, press  and select New route.
- 2 The route is given a default name:
  - i Change the name if necessary.
  - ii Select Ok.
- 3 To enter the legs of the route:
  - i Move the cursor to the start of the route and press .
  - ii A waypoint is created with a default name. To save this waypoint press enter, to edit the waypoint refer to 5-2-7
  - iii Press  a dotted leg line is displayed from the cursor to the previous waypoint
  - iv Move the cursor to the end of the first leg and press .
  - v Repeat i to iv until the last waypoint in the route is placed and saved
  - vi Press  to complete the route



Menu options while creating a route:

- 1 To add a waypoint to the route
  - i Press  and select Add.

- 2 To insert a waypoint in the route by breaking one leg into two:
  - i Move the cursor to the leg you want to break.
  - ii Press  and select Insert.
  - iii Move the cursor to where the new route waypoint will be.
  - iv Press .
- 3 To move a waypoint in the route:
  - i Move the cursor to the waypoint to move.
  - ii Press  and select Move.
  - iii Move the cursor to where the waypoint will be.
  - iv Press .
- 4 To remove a waypoint from the route:
  - i Move the cursor to the waypoint to remove from the route.
  - ii Press  and select Remove. The waypoint is removed from the route, but the waypoint is not deleted.
- 5 To start navigating the route
  - i Press  and select Start
- 6 To end creating the route
  - i Press  and select End
- 7 To delete the route
  - i Press  and select Delete
  - ii Select yes to confirm.

 **Tip:** The distance and bearing calculator can also be used to enter a course and save it as a route (see section 3-3).

#### B. Creating a new route from the routes display

- 1 In the routes display, press  and select Create.
- 2 A new route, with a default name and no waypoints, is displayed.
- 3 To change the route name:
  - i Select the route name at the top of the display and press .
  - ii Change the name if necessary.
  - iii Press .

- 4 To insert a waypoint in the route:
    - i Select where the waypoint will be:
      - To insert the first waypoint in a new route, select Leg 1.
      - To insert a waypoint at the end of the route, select the unused leg at the end of the list of waypoints.
      - Otherwise, select the waypoint to insert the new waypoint in front of.
    - ii Press **ENT**. A list of waypoints is displayed. Select the waypoint to use. As waypoints are inserted, the distance and bearing of each leg is shown automatically. If the route has more waypoints than will fit on the display, press **▲** or **▼** to see them.
  - 5 To remove a waypoint from the route:
    - i Select the waypoint to remove.
    - ii Press **MENU** and select Remove .
  - 6 Repeat this process until the route is finished.
  - 7 Press **ESC** .
  - 8 Display the route on the chart (see section 6-2-3) and check that the route does not cross land or dangerous water.
- See section 3-1-3.

---

### 6-2-2 Editing a route

#### Editing a route from the chart

- 1 In the routes display, select the route to edit. Press **MENU** and select Edit on chart .
- 2 The selected route is displayed on the chart, with a circle around the first waypoint.
- 3 Edit the route as described in section 6-2-1 A, starting at step 4.

#### Editing a route from the routes display

- 1 In the routes display, press **▲** or **▼** to highlight the route to edit. Press **MENU** and select Edit .
- 2 The selected route is displayed: the route name and a list of the waypoints.
- 3 Edit the route as described in section 6-2-1 B, starting at step 3.

---

### 6-2-3 Displaying a route on the chart

To view the selected route at the centre of the display:

- 1 In the routes display, press **▲** or **▼** to highlight the route to display. Press **MENU** and select Display .
- 2 The EXPLORER displays the selected route on the chart.

Or, in the Chart display, press **MENU**, select Find, then select Route . Select a route from the list.

---

### 6-2-4 Deleting a route

- 1 In the routes display, press **▲** or **▼** to highlight the route to delete. Press **MENU** and select Delete .
- 2 Select Yes to confirm.

---

### 6-2-5 Deleting all routes

- 1 In the routes display, press **MENU** and select Delete all .
- 2 Select Yes to confirm.

---

### 6-2-6 Navigating a route

See section 3-1-3.

## 7 Satellites

---

### **GPS worldwide navigation**

The US Government operates the GPS system. Twenty-four satellites orbit the earth and broadcast position and time signals. The positions of these satellites are constantly changing. The GPS receiver analyses the signals from the closest satellites and calculates exactly where it is on earth. This is called the GPS position.

The accuracy of the GPS position is typically better than 10 m (33 ft) for 95% of the time. A GPS antenna can receive signals from the GPS satellites when it is almost anywhere on earth.

### **DGPS**

A DGPS system uses correction signals to remove some of the errors in the GPS position. The EXPLORER can use one of two types of DGPS system:

- WAAS and EGNOS DGPS

WAAS and EGNOS are two satellite based DGPS systems. The correction signals are broadcast by satellites and are received by the EXPLORER standard GPS antenna. The accuracy of the corrected GPS position is typically better than 5 m (15 ft) for 95% of the time.

WAAS covers all of the USA and most of Canada. EGNOS will cover most of Western Europe when it becomes operational.

- Differential beacon DGPS

Differential beacons are land based radio transmitters that broadcast correction signals that can be received by a special receiver on the boat. Differential beacons are usually only installed near ports and important waterways, and each beacon has a limited range. The accuracy of the corrected GPS position is typically better than 2 to 5 m (6 to 16 ft).

### **GPS receiver**

Northstar GPS units have a sensitive 12-channel receiver, which tracks signals from all GPS satellites visible above the horizon and uses measurements from all satellites more than 5° above the horizon to calculate the position.

Each time a GPS receiver is turned on, it normally takes about 50 seconds before it outputs the first position. Under some circumstances it will take up to two minutes or longer.

## 7-1 Satellite display

The satellite display has information about the GPS satellites and GPS position.

To go to the satellite display, press **DISP**, select **Other**, then select **Satellite**.

**The satellite display shows:**

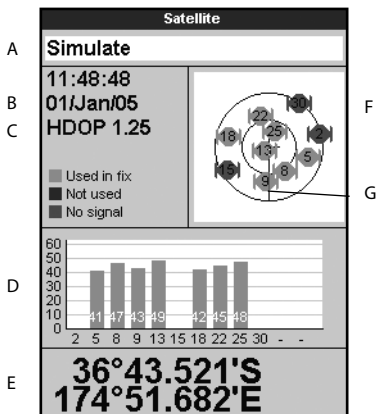

- A Status of GPS antenna, for example Acquiring, GPS fix, No GPS. If the unit is in Simulate mode it displays Simulate (see section 2-7)
- B Time and date from GPS satellites. Time is local time (UTC [GMT] plus local offset, see section 14-10)
- C HDOP: The error in the GPS position caused by satellite geometry. A low value indicates a more precise fix, a high value a less precise fix
- D Signal strengths of up to twelve visible GPS satellites. The higher the bar the stronger the signal
- E Boat position
- F Positions of visible GPS satellites:
  - Outer circle is horizon
  - Inner circle is 45° elevation
  - Centre is directly above
  - North is at top of display
- G If the boat is moving, COG is a line from centre

## 8 Gauges display

The Gauges display shows boat data, such as water speed, as analog or digital gauges.

To go to the Gauge display, press **DISP** and select **Chart**, then select **Chart+Gauges**.

If necessary, press **DISP** twice to switch to the Gauges display (see section 2-8-1).

Before using the Gauge display, set **Speed range**, **Max RPM** and **Max fuel flow** (see sections 14-3 and 14-4).

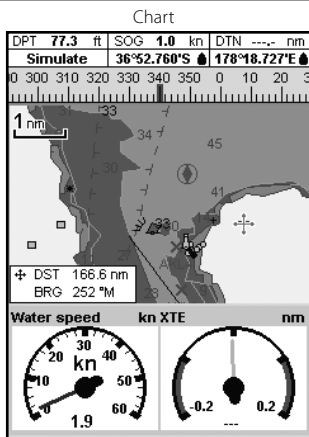

Gauges

## Changing the Gauges display

- 1 Go to the Gauges display and press **MENU**.
- 2 To select the gauge type.
  - i Select Gauge type.
  - ii Select Analog (round) or Digital (numbers).
- 3 To change the data displayed:
  - i Select Gauge setup.
  - ii Change a gauge:
    - a) Press the cursor keys to highlight the gauge.
    - b) Press **ENT** to display a menu of data items.
    - c) Select a data item that is available on your system.
  - iii Repeat the above step to set the other gauges. Press **ESC**.
- 4 Press **ESC** to return to the Gauges display.

## 9 Data display

Data	
Depth ft	Water speed kn
79.9	2.3
Water temp °F	Course °M
68.0	340
Latitude	
36°52.728'S	
Longitude	
178°18.727'E	

The data display has large numeric data fields. To go to the data display, press **DISP**, select **Other**, then select **Data**.

To select what data is displayed:

- 1 Press **MENU** and select **Data setup**.
- 2 Change a data field:
  - i Press the cursor keys to highlight the field.
  - ii Press **ENT** to display a menu of data items.
  - iii Select a data item that is available on your system or select **None** to leave the field empty.
- 3 Repeat the above step to set the other data fields.
- 4 Press **ESC**.

# 10 Fuel functions and display

The Fuel functions require optional petrol/gasoline or SmartCraft fuel sensors to be installed and set up.

## 10-1 What the fuel computer does

Each engine has a flow sensor installed to measure the engine's fuel flow.

The EXPLORER uses these flows, together with boat speed and engine RPM if available to estimate the fuel remaining in the tank(s), fuel used, range and fuel economy. This data is displayed on the fuel display (see section 10-2).

You can:

- display the fuel used during a trip (see section 10-2)
- set low fuel alarms (see section 10-4)
- make fuel consumption curves - graphs of fuel consumption and boat speed as a function of engine RPM - to monitor and optimise boat performance. (see section 10-6)

## 10-2 Fuel display

To go to the Fuel display, press **DISP**, select Other, then select Fuel.

The display differs according to the number of engines and tanks. If engine RPM is available and if you have made and selected a Fuel Consumption Curve (see section 10-6), press **▶** to switch between a Summary or a Fuel curve display.

### The Fuel display shows

#### Speed

To select a boat speed sensor, see section 10-5-1.

#### RPM (if available)

If engine RPM is not available, the display shows depth.

#### Remaining

The fuel remaining in the tank(s) is shown as a vertical gauge on the right of the display. The height of the yellow bar(s) show how much fuel remains in the tank(s). If you have set a low fuel alarm (see section 10-4), a red bar shows the level at which the alarm will trigger. If there are two tanks, the left bar shows the port tank, the right bar shows the starboard tank.

### **WARNING**

To ensure the fuel data is accurate:

- When you add or remove fuel from a tank, tell the EXPLORER (see section 10-3)
- If the boat has petrol/gasoline sensors, calibrate them during installation or if the fuel readings seem inaccurate (see section 10-7)
- Choose an appropriate type of boat speed sensor to calculate economy, range and the fuel consumption curve (see section 10-5)
- If the boat uses a paddlewheel sensor to measure speed, calibrate it during installation or if the speed readings seem inaccurate.

#### Used

The fuel used during a trip. On a multi-engine boat, the data for the port engine is on the left of the display.

When you want to start measuring how much fuel is used, go to the Fuel display and:

- In a single engine boat, press **MENU** and select Clear used.
- In a multi-engine boat, the fuel used by each engine and the total fuel used are shown. Press **MENU**, select Clear used and select:
  - Port or Starboard to clear the fuel used by one engine
  - Both to clear the total fuel used.

#### Fuel flow

The fuel flow for the engine(s). On a multi engine boat, the data for the port engine is on the left of the display. Use the flows to check the load of each engine.

## Fuel display without engine RPM

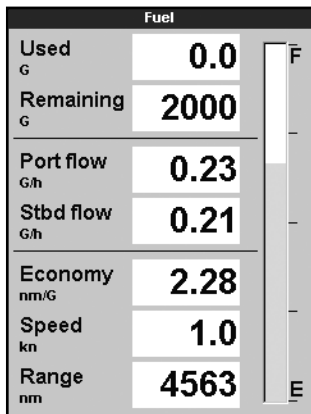

## Fuel display with engine RPM

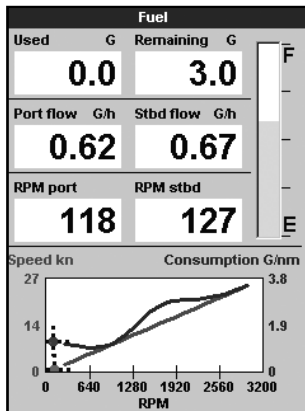

### Range

The estimated boat range at the current fuel flow. The value can depend on the type of speed sensor (see section 10-5).

### Economy

The distance travelled per unit of fuel used. The value can depend on the type of speed sensor (see section 10-5). The larger the value, the better the fuel economy. Adjust the throttle and trim to achieve the best economy.

### Fuel consumption curve

A graph of fuel consumption and boat speed as a function of engine RPM. Use the curve to monitor and optimise boat performance (see section 10-6).

## 10-3 When you add or remove fuel

When you add or remove fuel, you must tell the EXPLORER, otherwise the fuel data will be meaningless.

### A When you completely fill a tank

Go to the fuel display and press **MENU**.

Then:

- On a single-tank boat, select Fill tank.
- On a multi-tank boat, select Fill tank, then select the tank you have filled.

**Note:** Underfloor fuel tanks are often difficult to refill to the same level twice, due to air pockets.

### With underfloor fuel tanks:

- Trim the boat to the same angle in the water each time you follow procedure A.
- Mostly use procedure B below when adding fuel, but completely fill the tank and follow procedure A about every tenth time you add fuel.

### B When you part fill a tank

- 1 Add fuel to a tank and write down how much fuel you add.
- 2 From the Fuel display, press **MENU** and select Add fuel.
- 3 On a multi-tank boat, select the tank that you have added fuel to.
- 4 Change the number to the amount of fuel that you added.



**Note:** If you follow procedure B every time you add fuel, then a small error will accumulate, because it is hard to measure exactly how much fuel you add. To avoid this, completely fill the tank and follow procedure A about every tenth time you add fuel.

### C When you remove fuel

1. Before removing fuel, go to the Fuel display, press **MENU** and select Set remaining.
2. On a multi-tank boat, select the tank that you are removing fuel from.
3. Write down the value of Remaining for the tank; this is the amount of fuel originally in the tank.

4. Remove fuel from the tank and write down how much fuel you remove.
5. Subtract the amount of fuel you removed from the amount of fuel originally in the tank to calculate the amount of fuel now in the tank.
6. Change the number on the Set Remaining menu to the amount of fuel that you calculated was now in the tank.
7. Press **ENT**

**Note:** You can also use this procedure when you add fuel to a tank. In this case, add the fuel you have added to the amount of fuel originally in the tank to calculate the amount of fuel now in the tank.

## 10-4 Low fuel alarm

To set a low fuel alarm for a tank:

1. Press **MENU** one or more times to display the Setup menu, select Fuel then select Setup tanks.
2. On a multi-tank boat, select the tank to set the alarm for.
3. Select Fuel alarm and enter a fuel level to trigger the low fuel alarm; or enter zero to disable the alarm.

When a low fuel alarm is set, the alarm's fuel level is shown on the fuel display tank levels as a red bar. The alarm can also be set using the Alarms setup menu (see section 14-7)

## 10-5 Boat speed sensors

### 10-5-1 Selecting a boat speed sensor

The fuel calculations can use boat speeds from the GPS, or from a paddlewheel sensor or pitot sensor if these optional sensors are installed:

- Paddlewheel and pitot sensors measure the speed through the water; GPS speed is speed over ground; these sensors can give different values for Range, Economy and the fuel consumption curves (see section 10-5-2).
- A pitot sensor is more accurate than a paddlewheel sensor at high speeds but is not accurate at low speeds. A paddlewheel sensor is more accurate than a pitot sensor at low speeds.

### To select an optional speed sensor

1. Press **MENU** one or more times to display the Setup menu, select Fuel and select Speed source.
2. To use a paddlewheel or pitot sensor, select Water speed, otherwise select Ground speed to use GPS speed.
3. If you selected Water speed and you have both a paddlewheel sensor and a pitot sensor:
  - i. Press **ESC**, select Smartcraft and select Speed type
  - ii. Select Paddlewheel or Pitot.

**Tip:** You can select a different speed sensor during a trip.

## 10-5-2 Water speed and ground speed

A paddlewheel sensor and a pitot sensor measure water speed, the boat speed through the water. A GPS measures ground speed, the boat speed over the bottom of the water. If there is a current, then these speeds will be different, and the log, trip log, economy and range will be different, as shown below.

Water speed is better for measuring the boat's potential performance, Ground speed is better for going to a destination because it takes currents into account. To select a speed sensor, see section 10-5-1.

### When the current is from ahead, ground speed is less than water speed

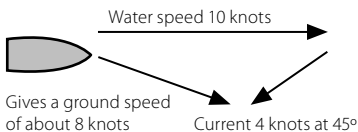
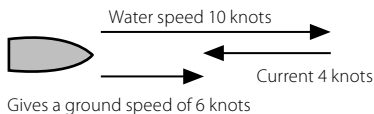

For this example:

If the boat travels for one hour, uses 3 gallons of fuel per hour and has 50 gallons of fuel left:

	Speed	Log	Economy	Range
Using water speed:	10 knots	10 nm	3.3 nm / gal	165 nm
Using ground speed:	6 knots	6 nm	2.0 nm / gal	100 nm

### When the current is from behind, ground speed is more than water speed

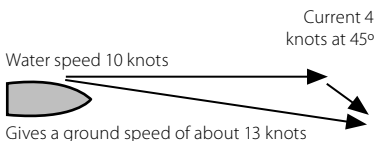
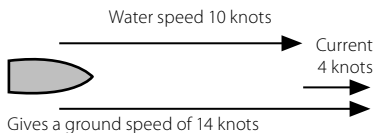

For this example:

If the boat travels for one hour, uses 3 gallons of fuel and has 50 gallons of fuel left:

	Speed	Log	Economy	Range
Using water speed:	10 knots	10 nm	3.3 nm / gal	165 nm
Using ground speed:	14 knots	14 nm	4.7 nm / gal	235 nm

## 10-6 Fuel consumption curves

A fuel consumption curve shows fuel consumption (fuel used per unit of distance travelled) and boat speed as a function of engine RPM. Fuel consumption curves require engine RPM, which requires SmartCraft sensors to be installed. Fuel consumption curves are powerful tools for assessing boat performance in different conditions and for helping you to run at the most economical speed for the conditions.

### 10-6-1 Making a fuel consumption curve

To make a fuel consumption curve you will need to run the boat in a straight line for about 15 minutes using the engine's full RPM range. For your first curve, choose a calm day with light wind and little current; have a typical load and a freshly cleaned hull. Later, you can make fuel consumption curves for different boat, weather or sea conditions. Compare these with your first curve to see how your boat's performance changes with conditions.

#### Making a curve

- 1 Start running the boat in a straight line.
- 2 Choose a speed source for the curve (see section 10-5-1). Normally choose Water speed to measure the boat's potential performance.
- 3 Press **MENU** one or more times to display the Setup menu, then select Fuel.
- 4 Select Fuel consumption curve, then select New.

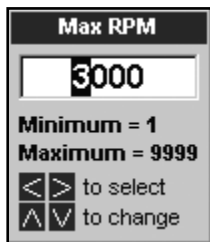

- 5 Enter the comfortable maximum RPM you know you can achieve for the engine rather than the maker's value.
- 6 The EXPLORER then asks you to set the minimum RPM. Set the throttle to idle; on a multi engine boat set all engines to about the same idle RPM.

Now, do not change the engine speed. Wait for about 60 seconds for the boat to stabilise, then press **ENT**. Wait while the fuel computer records the data.

- 7 The EXPLORER then asks you to set the throttle to achieve a target RPM. On a multi engine boat set all engines to about the target RPM. When the engine RPMs are correct, the Target RPM box will turn green.

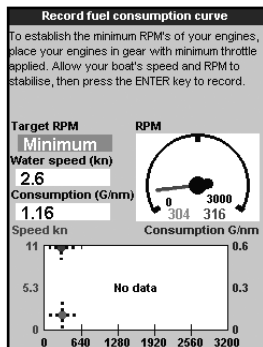

Now, do not change the engine speed. Wait for about 60 seconds for the boat to stabilise, ensuring the Target RPM box stays green. Then press **ENT**. Wait while the fuel computer records the data.

- 8 The EXPLORER repeats the above step to record data up to the maximum RPM. Then the EXPLORER asks if you want to save the curve. Select Yes. The fuel computer asks for a name for the curve. Change the default name if required. Then press **ENT**. The EXPLORER stores the new curve.

**Note** To interrupt making the curve at any time, press **ESC**.

## 10-6-2 Managing fuel consumption curves

### Renaming a curve

- 1 Press **MENU** one or more times until the Setup menu is displayed, then select Fuel.
- 2 Select Fuel consumption curve. Select Name and select the name of the curve to rename.
- 3 Select Rename and press **ENT**. Change the name.

## 10-6-3 Using fuel consumption curves

### Deleting a curve

- 1 Press **MENU** once or more until the Setup menu is displayed, then select Fuel.
- 2 Select Fuel consumption curve. Select Name and select the name of the curve to delete.
- 3 Select Delete.

### Selecting a curve

- 1 You must make a fuel consumption curve before you can use it (see section 10-6-1).
- 2 On the Fuel display, press **MENU**, select Fuel consumption curve and select the name of the curve to use.
- 3 On the fuel display, press **▶** if necessary to select Fuel curve and display the fuel consumption curve.

### Note

- a On a multi engine boat, keep the RPM of all engines similar while using a curve.
- b The shape of the curve depends on the type of speed sensor you selected when making the curve (see sections 10-5-1 and 10-5).

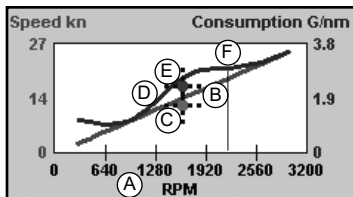

## Using a curve

Compare your boat's performance now, at the current RPMs, with the boat's performance when you made the curve. You can compare your boat's performance now with a curve made under ideal conditions or with a curve made under similar conditions.

### Information in a curve

- A RPM of the boat now. For a twin engine boat, the RPM is the average of the two RPMs.
- B Red curve: boat speeds at different RPMs recorded when you made this fuel consumption curve.
- C Red marker: the boat speed now. This marker is below the red curve, showing that the boat speed now at this RPM is less than when you recorded the curve.
- D Blue curve: fuel consumption at different RPMs recorded when you made this fuel consumption curve.
- E Blue marker: the fuel consumption now. This marker is below the blue curve, showing that the fuel consumption now at this RPM is better than when you recorded the curve.
- F If the blue curve has a dip, then running the boat at this RPM will give the best speed for the least fuel consumption.

## 10-7 Calibration

---

Calibrate petrol/gasoline fuel flow sensors during installation, or if the fuel readings seem inaccurate and the other troubleshooting suggestions do not help (see appendix B troubleshooting).

### Note

- SmartCraft fuel sensors are factory calibrated and should never need recalibrating.
- On a multi engine boat, calibrate each engine's sensor. This can be done at the same time with a portable tank for each engine or at different times using one portable tank.
- Calibrating a sensor requires accurate measurement of the fuel consumption. This is best done using a small portable tank. At least 4 gallons (15 litres) of fuel should be used to ensure an accurate calibration.
- It is often very difficult to fill underfloor tanks to the same level twice due to air pockets, so the more fuel used, the more accurate the calibration.

To calibrate the sensor(s):

- 1 Record the level of the fuel in the tank(s).
- 2 Connect the portable tank(s) to the engine through the fuel sensor(s).
- 3 Run the engine at normal cruising speed until at least 4 gallons (15 litres) of fuel has been used per engine.
- 4 Check the actual amount of fuel used per engine by refilling the portable tank(s) to the original level and noting the reading(s) of the fuel dispenser's gauge.
- 5 Press **MENU** one or more times to display the Setup menu, select Fuel then select Setup engines.
- 6 On a single engine boat, select Calibrate and change the displayed value to be equal to the reading of the fuel dispenser's gauge, then press **ENT**.  
On a multi-engine boat select the engine. Select Calibrate and change the displayed value to be equal to the reading of the fuel dispenser's gauge, then press **ENT**. Repeat for the other engines.

## 11 Tides display

The tides display is available on C-MAP charts.  
The tides display shows tide information at a tide station for the selected date.

**Note:** The tides display requires the local time offset to be set to work correctly (see section 14-10)

To show the tides display for the tide station nearest to the boat, press **DISP**, select **Other**, then select **Tides**.

To go to the tides display for any tide station:

- 1 From the chart display, press **MENU** and select **Find**.
- 2 Select **Tide stations**.

- 3 A list of tide stations are displayed. Select the tide station to display. The chart redraws with the tide station centred.
- 4 Press **MENU** and select **Chart info**.
- 5 Select **Tide height**.

### Choosing the date of the tide chart

- 1 Press **MENU**.
- 2 Select **Today**, **Next day** or **Prev day**.  
To choose a different date from these, select **Set date**, edit the date, press **ENT**.

### The tides display shows data for the chosen date

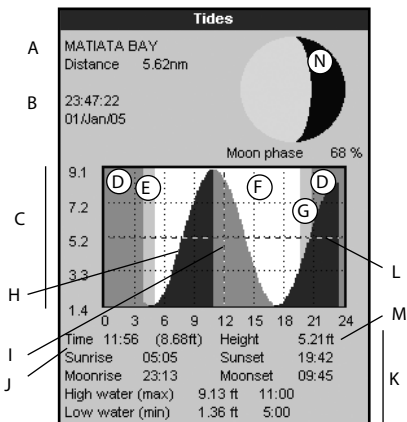

- A Tide station name and distance from boat
- B Current time and chosen date for display
- C Tide chart
- D Night
- E Dawn
- F Day
- G Dusk
- H Tide height
- I Time cursor, a vertical dotted line. Press **←** or **→** to move cursor sideways
- J Time of cursor and tide height at that time
- K Data for the chosen date
- L Tide height cursor, a horizontal dotted line. Press **▲** or **▼** to move cursor up and down.
- M Height of cursor on the tide chart
- N Moon phase for moon at the current time on the chosen date

## 12 User card display

A C-MAP™ user card is an optional plug-in card that can store data files (see section 1-3). There are three types of files: waypoints, routes or a track.

To go to the user card display, press **DISP**, select Other, then select User card.

### Note:

- 1 Before using a user card, remove any chart card and plug the user card in. When you have finished with the user card, remove the user card and replace the chart card (see section 1-3).
- 2 The older 5 volt cards are not supported.

### The user card display has:

#### File list

A list of the files on any user card in the EXPLORER. If there are more files than will fit on the display, press **+** or **-** to scroll up or down a page at a time.

#### Waypts, Routes

The number of waypoints and routes currently in the EXPLORER.

#### Track 1 to Track 5

The number of points in tracks 1 to 5 currently in the EXPLORER.

### Note:

- 1 To save EXPLORER data onto the user card, use the Save command (see below).
- 2 Data stored on the user card and shown on the file list is not available to be used by the EXPLORER until loaded into the EXPLORER with the LOAD command (see below).

### Saving data to the user card

This saves all the EXPLORER's waypoints, all the EXPLORER's routes or one of the EXPLORER's tracks to one file on the user card.

- 1 Press **MENU** and select Save.
- 2 Select Waypts, Routes or Tracks.
- 3 For Tracks, select the track number to save.
- 4 The new file is created. Change the name if required. The new file appears in the file list.

User card			
Name	Type	Date	Time
Device not present			
<b>In memory</b>		Track 2:	0
Waypts: 57		Track 3:	0
Routes: 11		Track 4:	0
Track 1: 2000		Track 5:	0

### Loading data from the user card to the EXPLORER

This loads one file from the user card to the EXPLORER:

- A waypoints file: The new waypoints are added to any existing waypoints in the EXPLORER. If a new waypoint has the same name as an existing waypoint but has different data, the EXPLORER displays both waypoints. Select:

**Skip:** Do not load the new waypoint.

**Replace:** Load the new waypoint and replace the existing one.

**Skip all:** Do not load any new waypoints which have the same names as existing waypoints.

**Rplc. all:** Load all new waypoints which have the same names as existing waypoints; the new waypoints replace the existing waypoints.

- A routes file: The new routes are added to any existing routes in the EXPLORER. If a new route has the same name as an existing route but has different data then the EXPLORER asks which route to keep.
- A track file: The new track will replace the existing track in the EXPLORER.

To load a file to the EXPLORER:

- 1 Select the file to load.
- 2 Press **MENU** and select Load.

### Deleting a file from the user card

- 1 Select the file to delete.
- 2 Press **MENU** and select Delete.
- 3 Select Yes to confirm.

### Reading the file information

This reads the file names from the user card and displays them. Reading does not load any file data into the EXPLORER.

- 1 Press **MENU** and select Card.
- 2 Select Read.

### Formatting the user card

Formatting prepares a user card for use. Format the card if there is an error message saying that the card is not formatted. Any data files on the card are deleted.

- 1 Press **MENU** and select Card.
- 2 Select Format.
- 3 Select Yes to confirm.

### Sorting the file names

This sorts the displayed file names.

- 1 Press **MENU** and select Sort.
- 2 Select sort by Name, Type or Time.

## 13 About display

About			
EXPLORER 550			
Software: 1.3.3, May 10 2005			
Hardware	18.10	Bootloader	0.0.0
World chart	2.0	Cartography	6.1.7
Card: DM-C030.00 CHARLESTON AREA DEMO			
Waypoints	3000	57	Used
Routes	25	11	Used
Tracks	5	1	Used
Power/comms cable <input checked="" type="checkbox"/> Black			
1	<input checked="" type="checkbox"/> Black	Ground	
2	<input checked="" type="checkbox"/> Brown	+9V out	
3	<input type="checkbox"/> White	NMEA out	
4	<input checked="" type="checkbox"/> Blue	NavBus-	
5	<input checked="" type="checkbox"/> Red	12/24V in	
6	<input checked="" type="checkbox"/> Orange	NavBus+	
7	<input type="checkbox"/> Yellow	Ignition	
8	<input checked="" type="checkbox"/> Green	Ext Alarm	
Fuel cable <input type="checkbox"/> White			
1	<input checked="" type="checkbox"/> Black	Ground	
3	<input type="checkbox"/> White	NMEA in	

To show the about display, press **DISP**, select Other, then select About.

The about display shows:

- The software version and date.
- The world chart version.
- Any card fitted.
- The number of waypoints, routes and tracks in the EXPLORER.
- Wiring information for the EXPLORER connectors.

In the unlikely event of having to contact a Northstar dealer for service, quote the software version number and date.



## 14 Setting up the EXPLORER

The EXPLORER has a number of advanced features which are set up through the setup menu. We recommend that you become familiar with the operation of the unit using the default settings before making any changes to the data in these menus.

To go to a setup option menu, press **MENU** one or more times to display the setup menu, then select an option.

### Note:

- 1 The Setup menu options are explained in the following sections.
- 2 Section 2-1 describes how to set or change data in the setup menus.
- 3 The setup data available will depend on the optional sensors and instruments installed.



### 14-1 Setup > System

Press **MENU** once or more until the Setup menu is displayed, then select System:

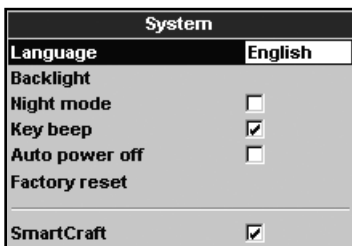

#### Language

Select the language for the displays. The options are: English, Italian, French, German, Spanish, Dutch, Swedish, Portuguese, Finnish and Greek.

**Tip:** In case you can't read the current language, the language setting is found at the top of the system menu.

#### Backlight

Select the backlight level for the keys and display (see also section 2-4)

#### Night mode

Night mode sets the palette for all displays.

- Normal palette, for daytime
- All displays have a palette optimised for night time.

See also section 2-4. To change only the chart palette, see section 14-2.

#### Key beep

Enables or disables the beep when a key is pressed.

#### Auto power off

See section 2-3.

## Setup option menus

Factory default settings are shown. The setup data available will depend on the optional sensors and instruments installed.

System  
(see 14-1)

System	
Language	English
Backlight	
Night mode	<input type="checkbox"/>
Key beep	<input checked="" type="checkbox"/>
Auto power off	<input type="checkbox"/>
Factory reset	
SmartCraft	<input checked="" type="checkbox"/>

Chart  
(see 14-2)

Chart	
Rotation	North
Palette	Normal
Map datum	WGS
NMEA datum offset	<input type="checkbox"/>
Map shift	Off
General	▶

General	
Plotter mode	<input type="checkbox"/>
AntiClutter	<input type="checkbox"/>
Value added data	<input type="checkbox"/>
Projected course	Off
CDI scale	0.5 nm
Lat/lon grid	<input type="checkbox"/>
Boundaries	Auto
Text/icon Size	Small

Water	
Water features	<input checked="" type="checkbox"/>
Bathymetric lines	<input checked="" type="checkbox"/>
Spot soundings	<input checked="" type="checkbox"/>
Bath & sndgs min	0 ft
Bath & sndgs max	50 ft
Tidal flow	<input checked="" type="checkbox"/>

Land	
Land features	

Other	
Waypoints	Se
Names	<input checked="" type="checkbox"/>
Lights	On

Water (14-2)

Land

Others (14-2)

GPS  
(see 14-3)

GPS	
GPS source	NMEA
DGPS source	WAAS/EGNOS
Static navigation	Off
Speed filter	5
Course filter	4
Speed range	Low

Fuel  
(see 14-4)

Fuel	
Source	Petrol
Num engines	2
Num tanks	2
Setup engines	▶
Setup tanks	▶
Diesel sensors	
Fuel consumption curve	▶
Speed source	Ground speed
Max fuel flow	1 G
Max RPM	7000

SmartCraft

(see the *SmartCraft Gateway Installation and Operation Manual*)

Track  
(see 14-5)

Track	
Record	1
Display	1
Plotting interval	Distance
Distance	0.1 nm
Time	10 sec
Memory used	100%
Send track	
Delete track	

Logs  
(see 14-6)

Logs	
Reset trip dist	
Reset total dist	
Reset engine hours	
Trip dist	0.32 nm
Total dist	0.32 nm
Engine hours	0.0 hrs

Alarms  
(see 14-7)

Alarms	
Arrival radius	Off
Anchor alarm	Off
XTE	<input type="checkbox"/>
Danger	Off
Low fuel	Off
DGPS	<input checked="" type="checkbox"/>

Units  
(see 14-8)

Units	
Distance	nm
Speed	kn
Depth	ft
Fuel	USGal
Compass	°M
Temperature	°F
Wind	True
Pressure	kPa
Baro	mB

Comms  
(see 14-9)

Comms	
NMEA out	<input type="checkbox"/>
NMEA data	▶
Lat/Lon d.p.'s	3
NavBus	<input type="checkbox"/>
NavBus group	0

Time  
(see 14-10)

Time	
Local offset	+00:00
Time format	24 hour
Date format	dd/MMM/yy

Simulate  
(see 14-11)

Simulate	
Simulate	<input type="checkbox"/>
Mode	Normal
Speed	1.0 kn
Course	0 °M
Route	AKL.DEMO

## Factory reset

This option returns all of the EXPLORER settings (except the language, waypoints and routes) to the default factory settings shown on the setup menus.

## SmartCraft

- No SmartCraft gateway is fitted. Disable SmartCraft functions.
- Normal SmartCraft operation

See section 15-7.

## 14-2 Setup > Chart

Press **MENU** once or more until the Setup menu is displayed, then select Chart:

Chart	
Rotation	North up
Palette	Normal
Map datum	WGS-84
NMEA datum offset	<input type="checkbox"/>
Map shift	Off
General	▶
Water	▶
Land	▶
Other	▶

### Rotation

The options for chart rotation are:

**North up**: North is always at the top of the chart display.

**Track up**: The chart is rotated so that the boat direction is to the top of the display. This option is useful for navigating narrow harbours or rivers. The EXPLORER asks for a course deviation; this is how much the boat direction needs to change to make the chart redraw.

 **Tip:** If the chart redraws too frequently, increase the course deviation setting.

**Course up**: This option is only available if the boat is navigating to a destination. The chart is rotated so that the plotted course to the destination is vertical.

### Palette

Select the color scheme for the LCD display. The options are:

**Normal**

**Sunlight**: Brighter colors, more visible in sunlight.

**Night**: Reversed colors for night, to preserve night vision.

### Map datum

EXPLORER GPS positions are based on a worldwide reference (datum) known as WGS 84. Most paper charts are based on WGS 84. However, some paper charts are based on other datums. In these cases, the latitude and longitude coordinates of objects on the EXPLORER chart display are different to the latitude and longitude coordinates of these objects on the paper chart. This applies to all objects, such as the boat, waypoints, tracks, lines of latitude and longitude and cartographic features such as land, rocks, buoys and depth contours.

Use **Map datum** to select the EXPLORER map datum to match the datum of the paper chart. Then, the latitude and longitude coordinates of objects displayed on the EXPLORER will change to match the corresponding coordinates on the paper chart.

General	
Plotter mode	<input type="checkbox"/>
AntiClutter	<input type="checkbox"/>
Value added data	<input type="checkbox"/>
Projected course	Off
CDI scale	0.5 nm
Lat/lon grid	<input type="checkbox"/>
Boundaries	Auto
Text/icon Size	Small

Water	
Water features	<input checked="" type="checkbox"/>
Bathymetric lines	<input checked="" type="checkbox"/>
Spot soundings	<input checked="" type="checkbox"/>
Bath & sndgs min	0 ft
Bath & sndgs max	50 ft
Tidal flow	<input checked="" type="checkbox"/>

Other	
Waypoints	Selected
Names	<input checked="" type="checkbox"/>
Lights	On
Nav-aids	INT
Attention areas	<input checked="" type="checkbox"/>

Land	
Land features	<input checked="" type="checkbox"/>
Land elevation	<input checked="" type="checkbox"/>

## Setting map datum

- 1 In the Chart setup menu, select Map datum.
- 2 Select the map datum for the paper chart you are using.
- 3 If you select a datum other than WGS 84 the EXPLORER asks if you want to apply the NMEA datum offset (see below).

### WARNING

When you change to a chart with a different datum, change the EXPLORER map datum again.

## NMEA datum offset

If you select a map datum other than WGS 84, the map datum offset can be applied to latitude and longitude coordinates sent on the EXPLORER NMEA output:

Latitude and longitude coordinates displayed on any NMEA repeater do not match the coordinates on the EXPLORER. Latitude and longitude coordinates broadcast on any NMEA VHF transmitter will be the same as the coordinates on a WGS 84 chart.

Latitude and longitude coordinates displayed on any NMEA repeaters match the coordinates on the EXPLORER. However, latitude and longitude coordinates broadcast on any NMEA VHF transmitter will be slightly offset from coordinates on a WGS 84 chart.

## Map shift

### WARNING

Map shift is for eliminating minor offsets. It should not be used if the correct datum is available. Use map shift with caution: incorrect application will cause incorrect boat positions.

Some charts have consistent position errors. To correct this, apply a map shift. After a map shift:

- The positions of cartographic features (such as land, rocks, buoys and depth contours) move on the EXPLORER chart display to where they should be.
- The positions of the boat, waypoints, tracks, and lines of latitude and longitude on the EXPLORER chart display remain unchanged.





## Applying a map shift

- 1 Move the boat to a known point on the chart, for example a marina berth.
- 2 In the Chart setup menu, select Map shift.
- 3 Move the cursor to the position on the chart where the boat actually is.
- 4 Press **MENU** and select Set.
- 5 Press **ESC** to set the new map shift. The boat will now be displayed at its actual location.

## Clearing the map shift

Clearing the map shift removes any map shift from the cartographic features on the EXPLORER chart display.

- 1 In the Chart setup menu, select Map shift.
- 2 Press **MENU** and select Clear.
- 3 Press **ESC**.

General submenu	
<b>Plotter mode</b>	<input type="checkbox"/> Normal: only scales available on the chart card can be displayed. <input checked="" type="checkbox"/> If you press  or  to select a chart scale which is not available, on the chart card, the chart display will change to this scale but will only display the boat position and track (if enabled). The rest of the display is white with black crosshatch lines and no chart information is displayed. This is useful to zoom to a small scale to track small boat movements or if there is no detailed chart for an area.
<b>Anticlutler</b>	<input type="checkbox"/> Names and icons shown. <b>Note:</b> this is independent of the change in detail shown at different zoom levels. <input checked="" type="checkbox"/> hides some less important names and icons to make the chart clearer.
<b>Value added data</b>	<input checked="" type="checkbox"/> Non marine chart data shown
<b>Projected course</b>	The EXPLORER can estimate the course after a given time, based on the current speed and heading (see section 3-4). The options are 2 minutes, 10 minutes, 30 minutes, 1 hour, 2 hours or Off.
<b>CDI scale</b>	See Appendix C. The options are 0.05, 0.1, 0.2, 0.5, 1.0, 2.0, 4.0 and 10.0 distance units.
<b>Lat/lon grid</b>	<input checked="" type="checkbox"/> displays a latitude and longitude grid.
<b>Boundaries</b>	Displays boundaries around areas where more detailed chart coverage is available: <b>Auto</b> shows the next four detail levels; <b>On</b> shows all.
<b>Text/icon size</b>	Select the size of chart text and icons.
Water submenu	
<b>Water features</b>	<input checked="" type="checkbox"/> displays marine sediment labels (for example, M shows areas of mud) and tide station icons 
<b>Bathymetrics</b>	Displays underwater depth contours between <b>Bath</b> & <b>sndgs min</b> and <b>max</b> .
<b>Spot soundings</b>	Displays depth soundings between <b>Bath</b> & <b>sndgs min</b> and <b>max</b> .
<b>Bath &amp; dndgs min</b>	The minimum depth for <b>Bathymetrics</b> and <b>Spot soundings</b> .
<b>Bath &amp; dndgs max</b>	The maximum depth for <b>Bathymetrics</b> and <b>Spot soundings</b> .
<b>Tidal flow</b>	<input checked="" type="checkbox"/> displays dynamic tide flows: arrows on a chart showing the present tide stream and orientation (requires a GPS fix and an NT-MAX card)
Other submenu	
<b>Waypoints</b>	Displays waypoints: <b>Hide all</b> only displays waypoints on any selected route; <b>Selected</b> displays waypoints with their display option set to <b>Icon</b> or <b>I+N</b> (Icon and Name) (see section 5).
<b>Names</b>	<input checked="" type="checkbox"/> displays place names.
<b>Lights</b>	Displays lighthouses: <b>No sector</b> hides any light sectors; <b>On</b> shows all data.
<b>Nav-aids</b>	Displays signals (fog, radar, radio stations) and bouys. <b>Int</b> and <b>US</b> select the icon format; <b>Simpl</b> draws simpler icons.
<b>Attention areas</b>	<input checked="" type="checkbox"/> displays attention area boundaries and information icons  ; attention areas are important areas, such as restricted anchorages or shallow areas.
Land submenu	
<b>Land features</b>	<input checked="" type="checkbox"/> displays land features, for example regions, rivers, roads, railways, airports.
<b>Land elevation</b>	<input checked="" type="checkbox"/> displays land contours, shaded like depths (requires an NT Max card)

## 14-3 Setup > GPS

Press **MENU** once or more until the Setup menu is displayed, then select GPS :

GPS	
GPS source	NMEA
DGPS source	WAAS/EGNOS
Static navigation	Off
Speed filter	5
Course filter	4
Speed range	Low

### GPS Source

- **Internal**: Use the internal GPS antenna (EXPLORER 550i) or the external GPS antenna supplied (EXPLORER 550) (see section 15-5).
- **NMEA**: Use an external GPS or DGPS source connected via NMEA (see section 15-9).
- **NavBus**: Use an external GPS or DGPS source connected via NavBus (see section 15-8).

### DGPS Source

Enables or disables the satellite based DGPS correction (see section 7). The options are None or WAAS/EGNOS. Do not enable WAAS/EGNOS outside their coverage areas or the accuracy of the position might be degraded.

WAAS covers all of the USA and most of Canada. To use WAAS, the GPS antenna must have a clear view of the sky towards the equator. EGNOS will cover most of Western Europe when it becomes operational.

### Restart GPS

Restarts the internal GPS receiver for servicing or troubleshooting. The GPS receiver takes up to three minutes to restart. The satellite display shows the status of the GPS receiver (see section 7). Restart the GPS if the receiver has not been used for some time and is taking a long time to get a GPS fix.

### Static Navigation

When the boat stops or moves very slowly, the calculated GPS speed and course become erratic. Static navigation is a number, and the options are:

- 0.01 to 99.9: If the boat speed is slower than this, the speed is displayed as zero and the course stays unchanged.
- 0 (Off): The calculated speed and course are always used.

### Speed and Course Filter

Waves and wind cause the boat speed and course to fluctuate slightly. To give stable readings, the EXPLORER calculates these values by taking several measurements and averaging them.

- A lower value averages measurements over a shorter period of time. This gives the most accurate value but has the most fluctuations.
- A higher value averages measurements over a longer period of time. This gives the most stable value but will ignore some true speed changes.

Set the Speed and Course filters to the lowest values which give stable readings. The range of each filter is 1 to 60 seconds or Off (0).

### Speed range

The maximum reading to display on an analog boat speed gauge (see section 8). Choose a range suitable for your boat.

## 14-4 Setup > Fuel

Fuel functions require optional fuel flow sensors to be installed. Press **MENU** one or more times until the Setup menu is displayed, then select Fuel:

Fuel	
Source	Petrol
Num engines	2
Num tanks	2
Setup engines	▶
Setup tanks	▶
Diesel sensors	
Fuel consumption curve	▶
Speed source	Ground speed
Max fuel flow	1 G
Max RPM	7000

### WARNING

Fuel consumption can change drastically depending upon the boat loading and the sea conditions. Always carry adequate fuel for the journey, plus a reserve.

#### Source

Select the fuel flow sensors to use if the boat has more than one set of fuel sensors. Normally select Auto.

#### Num engines

Set the number of engines, or select 0 to disable the fuel functions. If there are two engines they are called port and starboard.

#### Num tanks

Set the number of fuel tanks. If there are two tanks they are called port and starboard.

#### Setup engines

If the boat has more than one engine, select Engine and select each engine in turn.

For the selected engine, you can enter:

**From tank:** The fuel tank the engine is connected to.

**Flow filter:** Most engines do not draw fuel from the tank at a steady rate. To give a stable fuel flow reading, the EXPLORER calculates the flow by taking several measurements and averaging them. Use the Flow filter to set the period over which the fuel flow is averaged.

The Flow filter can be set from 0 to 30 seconds. Use the lowest value which gives a stable flow. Usually a value of 5 to 10 seconds will give a satisfactory result for two-stroke carburettor engines. Fuel injected or four-stroke engines may require a larger value.

This setting affects the Fuel flow and Fuel economy reading on the Fuel display but it does not affect the Fuel used reading.

#### Setup tanks

If the boat has more than one tank, select Tank and select each tank in turn.

For the selected tank, you can enter:

**Tank size:** The tank capacity. Northstar recommends measuring tank size by draining the fuel tank, filling it to capacity and using the fuel dispenser's reading. Beware of air pockets, especially in underfloor tanks.

**Fuel alarm:** See section 10-4.

#### Fuel consumption curve

See section 10-6.

#### Speed source

If both water speed and ground speed are available, select which to use for fuel calculations (see section 10-5-1).

#### Max fuel flow

The maximum fuel flow from a fuel tank to be displayed on an analog fuel flow gauge (see section 8)

## 14-5 Setup > Track

Press **MENU** one or more times until the Set up menu is displayed, then select **Track**:

Track	
Record	1
Display	1
Plotting interval	Distance
Distance	0.1 nm
Time	10 sec
Memory used	100%
Send track	
Delete track	

Tracking records and displays the boat's course on the chart (see section 3-5). Five different tracks can be recorded: track 1 has up to 2000 points and tracks 2, 3, 4 and 5 have up to 500 points each.

### Record

**Off:** The EXPLORER stops recording a track.  
**1 to 5** (select a track number): The EXPLORER starts recording the boat's course into the selected track.

### Display

**Off:** No track is shown on the chart.  
**1 to 5** (select a track number): The selected track is shown on the chart.

### Plotting Interval

The options are **Distance** or **Time**.

#### Distance

Select the distance plotting interval: 0.01, 0.05, 0.1, 0.5, 1.0, 2.0, 5.0 or 10.0 distance units.

#### Time

Select the time plotting interval: 1, 5, 10 or 30 seconds or 1 minute.

### Memory used

The percentage of memory used in the track being recorded.

 **Tip:** Use the user card display to check the number of points recorded in each track (see section 12).

### Send track

This option is included for compatibility with older units. For information, see your Northstar dealer.

### Delete track

The data in the track selected for Record (see above) is deleted.



## 14-6 Setup > Logs

Press **MENU** one or more times until the Setup menu is displayed, then select Logs :

Logs	
<b>Reset trip dist</b>	
<b>Reset total dist</b>	
<b>Reset engine hours</b>	
<b>Trip dist</b>	<b>0.32 nm</b>
<b>Total dist</b>	<b>0.32 nm</b>
<b>Engine hours</b>	<b>0.0 hrs</b>

The values can be changed independently of each other. These log values are saved when the unit is turned off.

### Reset trip dist

This resets the trip distance to zero.

### Reset total dist

This option resets the total distance to zero.

### Reset engine hours

Use this option to reset the engine hours to zero. This can be useful after an engine service or to count the engine hours between service intervals.

## 14-7 Setup > Alarms







Press **MENU** one or more times until the Setup menu is displayed, then select Alarms :

Alarms	
<b>Arrival radius</b>	<b>Off</b>
<b>Anchor alarm</b>	<b>Off</b>
<b>XTE</b>	<input type="checkbox"/>
<b>Danger</b>	<b>Off</b>
<b>Low fuel</b>	<b>Off</b>
<b>DGPS</b>	<input checked="" type="checkbox"/>

All alarms except Loss of GPS fix can be turned on (enabled) or off (disabled).

For the XTE and Loss of DGPS fix alarms, select  to turn the alarm on or select  to turn the alarm off. For the other alarms, enter a trigger value to turn the alarm on. The alarm will sound each time the alarm value equals the trigger value. For example, the Danger alarm will sound if the boat comes closer to a danger waypoint than the trigger value and the Anchor alarm will sound if the boat moves by more than the trigger value. To turn these alarms off, enter a trigger value of 0 (zero).

Icons for alarms that are on can be displayed in the data header (see section 2-8-2). An alarm icon is normally black and turns red when the alarm sounds.

Symbol	Alarm	Alarm sounds when it is on and the:
	Arrival radius	boat is closer to the destination or to a waypoint than the alarm trigger value
	Anchor alarm	boat moves by more than the alarm trigger value
	XTE	boat moves off course by more than the CDI scale (see section 14-2)
	Danger	boat comes closer to a danger waypoint than the alarm trigger value
	Low fuel	Low fuel remaining equals the alarm trigger value; on a multi-tank boat you can set separate alarms for each tank (see section 10-4)
	Loss of DGPS fix	EXPLORER can not receive the DGPS signal (beacon, WAAS or EGNOS)
	Loss of GPS fix	EXPLORER can not receive the GPS signal (this alarm is always on)

## 14-8 Setup > Units

Press **MENU** one or more times until the Setup menu is displayed, then select Units:

Units	
Distance	nm
Speed	kn
Depth	ft
Fuel	USGal
Compass	°M
Temperature	°F
Wind	True
Pressure	kPa
Baro	mB

The default units are shown above.

### Distance

nm (nautical miles), mi (miles) or km (kilometres)

### Speed

kn (knots), mph (miles per hour) or kph (kilometres per hour)

## 14-9 Setup > Comms

Use this feature when the EXPLORER is connected to other Northstar instruments through NavBus or any compatible NMEA instrument.

Press **MENU** once or more until the Setup menu is displayed, then select Comms:

Comms	
NMEA out	<input type="checkbox"/>
NMEA data	<input type="checkbox"/>
Lat/Lon d.p's	3
NavBus	<input type="checkbox"/>
NavBus group	0

### NMEA out

NMEA is generally used with third party instruments (see section 15-9). Select this to transmit NMEA sentences, for example to an autopilot.

### NMEA data

Use this to specify which NMEA sentences will be transmitted (see section 15-9 and Appendix A).

### Depth

ft (feet), m (metres) or fa (fathoms)

### Fuel

Litres, USGal (US gallons) or ImpGal (Imperial Gallons)

### Compass

°T (True north) or °M (Magnetic north)

### Temperature

°F (Fahrenheit) or °C (Celsius)

### Wind (optional)

Requires a wind instrument: True or App (Apparent)

**Note:** that the units for wind speed are the speed units.

### Pressure

Requires SmartCraft: kPa or psi

### Baro (Barometric pressure)

Requires a Northstar VHF receiver connected by NavBus: InHg or mB.

### Lat/lon dps

Select the number of decimal points used for latitude and longitude transmitted in NMEA sentences.

### NavBus

NavBus is the preferred method for connecting the EXPLORER to other Northstar instruments. Select this if the instruments are connected using NavBus.

### NavBus Group

Use this when a group of Northstar instruments are connected together using NavBus, to specify a group of instruments for backlighting, if required. Then, if the backlight setting on one instrument in the group is adjusted, the other instruments change automatically. Otherwise, select 0. See section 15-8.

## 14-10 Setup > Time

Press **MENU** once or more until the Setup menu is displayed, then select Time:

Time	
Local offset	+00:00
Time format	24 hour
Date format	dd/MMM/yy

## 14-11 Setup > Simulate

Simulate mode is a way of becoming familiar with the EXPLORER (see section 2-7).

Press **MENU** once or more until the Setup menu is displayed, then select Simulate:

Simulate	
Simulate	<input type="checkbox"/>
Mode	Normal
Speed	1.0 kn
Course	0 °M
Route	AKLDEMO

### Simulate

- Turn simulate mode off
- Turn simulate mode on



Never have simulate mode on when the EXPLORER is navigating on the water.

### Mode

There are two choices for Mode:

#### 1 Normal

Simulates the boat moving from the selected start point at the given speed and heading. The options required for Normal are:

- Speed: The simulated boat speed to use.
- Course: The simulated bearing for the boat to follow.

### Local offset

The difference between local time and UTC (GMT). Change local offset when daylight saving time starts and ends. The range is 0 to  $\pm$  13 hours, in 30 minute steps.

### Time format

The options are 24 hour or 12 hour.

### Date format

The options are dd/MMM/yy, MMM/dd/yy, dd/MM/yy or MM/dd/yy.

**Note:** To select the start point, go to the chart display before starting the simulation. Then:

- To start the simulation from the boat position, press **ESC** to switch to centre on boat mode.
- To start the simulation from a different point, move the cursor to that point on the chart.

**Tip:** To calculate a course, use the cursor (see section 3-3).

**Tip:** As the boat moves, vary Course to simulate the boat moving off course.

### 2 Demo

Simulates a boat moving along a route and automatically displays different EXPLORER functions.

The options required for Demo are:

- Speed: The simulated boat speed to use.
- Route: The route to follow.

## 15 Installation

---

Correct installation is critical to the performance of the unit. It is vital to read the entire installation section of this manual and the documentation that comes with the antenna and any other units before starting installation.

### 15-1 Installation: What comes with the EXPLORER 550/550i

---

- EXPLORER display unit
- Dust cover for display unit
- Blanking caps for unused connectors
- Power cable
- Mounting bracket (screws included)
- Flush mounting kit
- Northstar 133 GPS antenna for Explorer 550; the Explorer 550i has a built in GPS antenna.
- Warranty registration card
- This manual



### 15-2 Installation: Options and Accessories

---

- C-MAP™ NT-MAX, NT+ or NT chart cards.
- C-MAP™ user cards (3 V) for storing data. (The older 5 volt cards are not supported)
- Northstar carry bag.
- Northstar NavBus junction boxes simplify wiring, particularly if several instruments are connected. For more information, see the *NavBus Installation Manual*.

## Optional sensors and instruments

**Fuel sensors:** These optional fuel flow sensors can be fitted to up to two engines:

- Northstar petrol/gasoline sensors (see section 15-6).

Engine types supported:

Outboard carburetted two stroke and EFI petrol/gasoline engines: 50 to 300 hp.

Outboard four stroke petrol/gasoline engines: 90 to 300 hp.

Inboard petrol/gasoline engines: 70 to 400 hp.

Flow rate (per engine):

Minimum: 5 litres per hour (1.3 U.S. gallons per hour).

Maximum: 130 litres per hour (34 U.S. gallons per hour).

- SmartCraft fuel sensors (see section 15-7)

## Connections

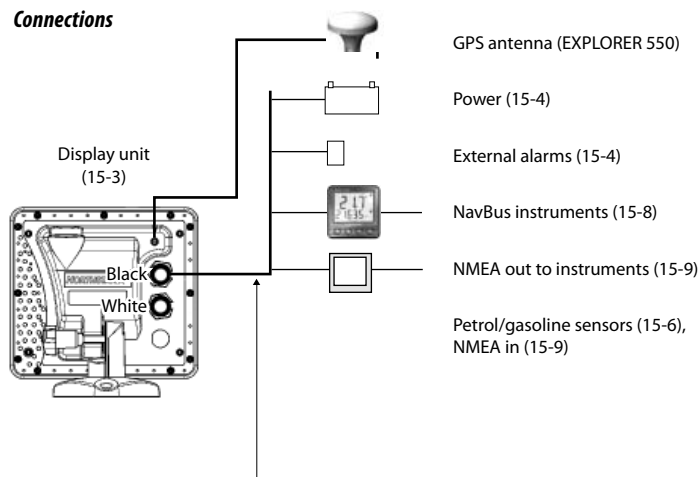

### Power/data cable

Pin	Wire	Function
1	Black	Ground: - power in, NMEA ground. (The cable has two black wires which are connected inside the cable and it does not matter which black wire you use)
2	Brown	Power out, 9 V DC (not used)
3	White	NMEA out
4	Blue	NavBus-
5	Red	+ power in, 10.5 to 32 V DC
6	Orange	NavBus+
7	Yellow	Auto power in
8	Green	External alarm out, 30 V DC 200 mA maximum.

## 15-3 Installation: The display unit

Select a position for the display unit:

- At least 4" (100 mm) away from the compass, at least 12" (300 mm) away from any radio transmitter and at least 4 ft (1.2 m) away from any antenna.
- Easy to read and operate. If possible, mount the display unit in front of the navigator or to the right of the navigator because the LCD display is more readable from these positions.
- Not exposed to the direct sun or water and protected from physical damage during rough sea passages.
- Easy to access the 12/24 V DC power source and convenient to route the transducer cables.

For the EXPLORER, with the internal GPS antenna:

- The display unit must have a good view of the sky and horizon. The view should not be blocked by large parts of the superstructure.
- The unit can be under glass, perspex, fibreglass or fabric, but not under metal or wood.
- Do not mount the unit within 3 m (10 ft) of a radio transmitter antenna or within 0.5m (20 in) of the plane of a radar antenna.

There are two mounting arrangements:

### 1 Flush Mounting

Requires a solid panel with access behind for wiring and mounting screws. After flush mounting, the display unit cannot be tilted or moved after installation to reduce any unwanted glare or reflections. Carefully select the best viewing position before installation. This would generally be in a shaded area.

- 1 Cut a hole in the bulkhead for the display unit using the flush mount template.
- 2 Drill four holes for the mounting studs using the flush mount template.
- 3 Screw the four studs into the brass inserts in the back of the display unit.
- 4 Sit the display unit in place and fit the washers and nuts to the studs.

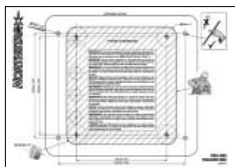

### 2 Bracket Mounting

Requires a panel for mounting the bracket. Ensure that the panel is not likely to deform and is not subject to excessive vibration. The bracket can be tilted and rotated. The display unit can be removed when it is not in use.

- 1 Hold the bracket in place and mark the screw holes.
- 2 Drill the screw holes and screw the bracket in place. Do not overtighten the screws or the display unit might not rotate.
- 3 Hold the display unit in place on the mounting bracket shaft. Hand tighten the knob on the mounting bracket.



## 15-4 Installation: Power/Data cable

The power/data cable has a black locking collar and flying leads.

- 1 Wire the EXPLORER for auto power to have the EXPLORER turn on with the boat's ignition switch or to record engine hours or to record the total fuel used. Otherwise wire for basic power (for more information, see section 2-2).

### Basic power

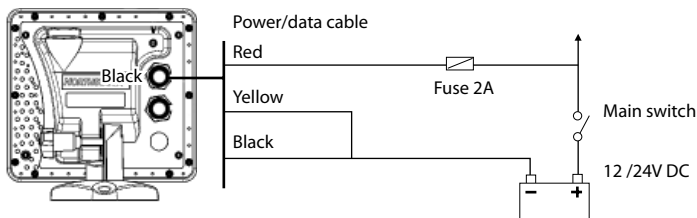

### Auto power

During setup, set up Auto power off (see sections 2-2 turning on and off and 14-1 Setup system)

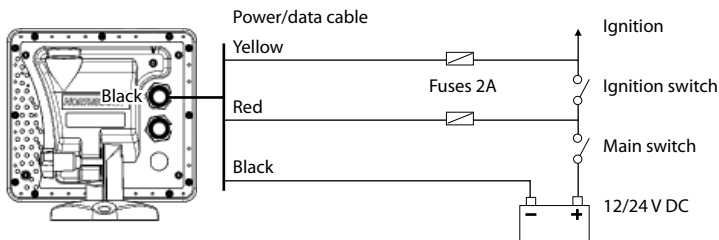

- 2 Wire any external alarm beepers or lights. The alarm output switches to ground to sound the alarm. If the current is more than 200 mA, fit a relay.
- 3 Connect the power/data cable to the black display unit connector; turn the collar to lock the connector.

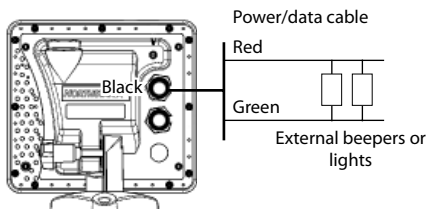

## 15-5 Installation: GPS antenna

### Selecting an antenna

Fit one of these GPS antennas:

- Normally use the internal GPS antenna (EXPLORER 550i) or the GPS antenna supplied (EXPLORER 550).
- An optional differential beacon DGPS antenna to give enhanced accuracy within range of land based differential beacons in areas where WAAS or EGNOS are not available. Such a DGPS antenna has both a GPS receiver and a beacon receiver, and it automatically applies the beacon correction to the GPS position.
- A compatible GPS or DGPS instrument or antenna connected by NavBus (see section 15-8) or NMEA (see section 15-9). In this case, the EXPLORER does not need its own antenna.

### Note:

- The EXPLORER can apply the WAAS and EGNOS DGPS corrections to any GPS antenna.
- To configure the EXPLORER for different antenna options, see section 14-3.

For more information, contact your Northstar dealer.

### Installing an antenna

If an external antenna is required, install the antenna and fit the antenna cable back to the display unit. Follow the instructions in the manual supplied with the antenna. Fit an optional Northstar extension cable if required.

Connect the EXPLORER external antenna to the gold EXPLORER connector:

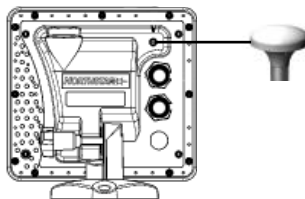

During setup, configure the EXPLORER for the chosen antenna, see section 14-3.

## 15-6 Installation: Northstar petrol/gasoline sensors

Fit the optional petrol/gasoline fuel kit following the instructions supplied with the kit.

### Note:

- Fit one kit for each engine, up to two engines.
- SmartCraft engines have fuel flow sensors, therefore Northstar fuel sensors are not required as well.
- Wire for auto power (see section 15-4).

During setup enter fuel setup data (see section 14-4)

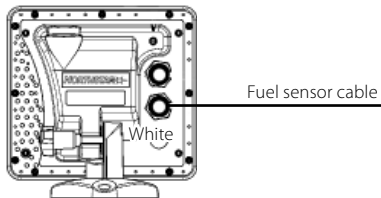



## 15-7 Installation: SmartCraft

The EXPLORER can be connected to up to two SmartCraft capable Mercury petrol/gasoline engines. The EXPLORER can display engine data and trim and can control troll speed.

### Note:

- Connect the EXPLORER to the SmartCraft engines with a Northstar SmartCraft gateway:
  - i For single engine fit a single gateway
  - ii For dual engines fit a dual gateway
- SmartCraft engines have fuel flow sensors, therefore Northstar fuel sensors are not required as well.
- Wire the unit for auto power (see section 15-4).

### During setup

- a Enter fuel setup data (see section 14-4)
- b Set NavBus and SmartCraft to  (see section 14-1)

- c Enter smartcraft setup data (see the *SmartCraft Gateways Installation and Operation Manual*)

For information on installing, setting up and using SmartCraft, see the *SmartCraft Gateways Installation and Operation Manual*.

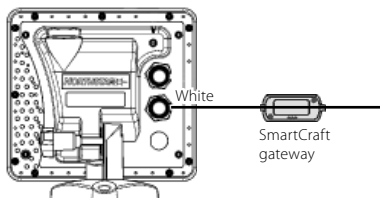

## 15-8 Installation: Other NavBus instruments

NavBus is Northstar's system for connecting instruments together to interchange data and share transducers. When instruments are connected by NavBus:

- If the units, alarms or calibration are changed in one instrument, then the values will automatically change in all other instruments of the same type.

- Each instrument can be assigned to a group of instruments. If the backlight is changed in an instrument in group 1, 2, 3 or 4 then the backlight will automatically change in the other instruments in the same group.

If the backlight is changed in an instrument in group 0 then no other instruments are affected.

- If an alarm sounds, mute it by clearing the alarm on any instrument which can display that alarm.

### NavBus and the EXPLORER

The EXPLORER can:

- Display wind speed and direction from an optional Northstar Wind instrument.
- Receive and display depth from an optional Northstar depth instrument.
- Receive and display boat speed and water temperature from a paddlewheel sensor on an optional Speed instrument.
- Receive barometric pressure from an optional Northstar VHF radio. The EXPLORER can display:

**Baro:** barometric pressure

**Baro history:** barometer history

**Weather:** a prediction, based on changes in barometric pressure

**Fish forecaster:** a prediction based on changes in barometric pressure

- Receive data from an optional GPS or GPS/DGPS source.
- Send data to optional Northstar instruments, for example to a repeater.

During setup for NavBus instruments, set NavBus to  and assign the instrument a NavBus group number (see section 14-9)

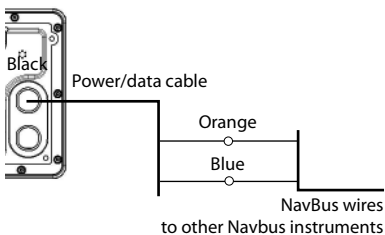

### 15-9 Installation: Other NMEA instruments

NMEA is an industry standard for interconnecting instruments. It is not as flexible or as easy to install as NavBus. The EXPLORER can:

- Receive and display wind speed and direction from an optional compatible wind instrument.
- Receive and display depth, paddlewheel boat speed and water temperature from an optional compatible instrument.
- Receive data from an optional compatible GPS or GPS/DGPS source.
- Send GPS position and other navigation data to an autopilot or other instrument. An autopilot requires APB, APA and VTG sentences (see section 14-9).

For information on sending NMEA data to the EXPLORER, see your Northstar dealer.

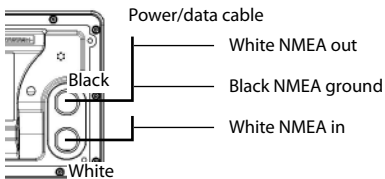

During setup to send NMEA data to other instruments, set NMEA out to  and specify the NMEA data to send (see section 14-9).

## 15-10 Installation: Setup and test

---

### Setup and test

- 1 Put a blanking cap on any unused connector on the back of the display unit. Ensure all connectors are plugged in and the display unit is in place.
- 2 If the display unit is bracket mounted, adjust tilt and rotation for best viewing and hand tighten the knob.
- 3 Insert any required C-MAP chart card (see section 1-3).
- 4 Turn the instrument on (see section 2-3). When the EXPLORER is turned on for the first time, it displays an installation menu:
  - i Select the language to use.
  - ii Change the data if necessary (see section 2-1)
  - iii When the setup data is correct, press
- 5 Enter setup data to set up the EXPLORER to your requirements and to set up any optional sensors or instruments (see section 14).
- 6 At the satellite display, check that it picks up GPS satellites. Wait for the GPS receiver to start up and the fix type to change from 'Acquiring' to 'GPS fix'. This should take less than two minutes (see section 7).
- 7 Go on a test run to check that the navigation equipment works correctly, particularly when a radio transmitter or radar is used.



This data can be changed later (see section 14).

# Appendix A - Specifications

---

## GENERAL

### Size:

EXPLORER 550/550i:  
150mm H x 164mm W x 65mm D  
(5.9" x 6.5" x 2.6")

### Display:

EXPLORER 550, 550i: 5" diagonal, TFT color, 234 x 320 pixels

**Backlight:** Display and keys

### Supply voltage

10.5 to 32 V DC.

### Supply current:

 at 13.8 V

300 mA min - no backlighting

550 mA max - full backlighting

**External beeper or light output:** Switched to ground to sound alarm, 30 V DC, 200 mA maximum.

### Operating temperature

0° to 50°C (32° to 122°F)

## ALARMS:

- User set: Arrival radius, anchor, XTE, danger, low fuel (optional), loss of DGPS fix
- Fixed: Loss of GPS fix

## GPS NAVIGATION

**Chart card:** C-MAP™ NT-MAX, NT+ or NT

**User card:** 3.3 V C-MAP™

**Waypoints:** Up to 3000, with default or user-defined alphanumeric names up to eight characters.

**Routes:** 25 Routes, with up to 50 points each

**Tracks:** By time or distance, one track of 2000 points and four of 500 points.

### Chart datums

- 121 Chart datums (see next page)
- One user-defined map shift.

**Chart scale:** 0.05 to 4096 nm for chart (chart dependent) down to 0.01 nm in plotter mode.

## COMMUNICATIONS

### NavBus

Connection to other Northstar instruments.

### NMEA

- NMEA 0183 ver 2 4800 baud
- Inputs from compatible instruments: DBT, DPT (preferred), GGA, GLL, GSA, GSV, MTW, MWV, RMC, VHW, VTG
- Outputs, for compatible instruments: APA, APB, BWR, GGA, GLL, GSA, GSV, RMB, RMC, VTG, XTE

## STANDARDS COMPLIANCE

### EMC:

- USA: FCC Part 15 Class B.
- Europe: (CE) EN301843-1:2004-06.
- New Zealand and Australia: (C Tick) EN60945 9.2 & 9.3.

**Environment:** IPx6/IPx7/CFR46 (with card holder and connections in place).

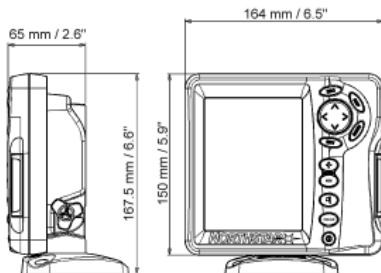

### EXPLORER 550

#### List of datums

Adindan	Afgooye	AIN EL ABD 1970
American Samoa 1962	Anna 1 Astro 1965	Antigua Island Astro 1943
ARC 1950	ARC 1960	Ascension Island 1958
Astro Beacon 'E' 1945	Astro DOS 71/4	Astro Station 1952
Astro Tern Island (Frig) 1961	Australian Geodetic 1966	Australian Geodetic 1984
Ayabelle Lighthouse	Bellevue (IGN)	Bermuda 1957
Bissau	Bogota Observatory	Bukit Rimpah
Camp Area Astro	Campo Inchauspe 1969	Canton Astro 1966
Cape	Cape Canaveral	Carthage
Chatham Island Astro 1971	Chua Astro	Co-ord. Sys.1937 Estonia
Corrego Alegre	Dabola	Deception Island
Djakarta (Batavia)	DOS 1968	Easter Island 1967
European 1950	European 1979	Fort Thomas 1955
Gan 1970	Geodetic Datum 1949	Graciosa Base Sw 1948
Guam 1963	Gunung Segara	GUX 1 Astro
Herat North	Hermannskogel	Hjorsey 1955
Hong Kong 1963	Hu-Tzu-Shan	Indian
Indian 1954	Indian 1960	Indian 1975
Indonesian 1974	Ireland 1965	ISTS 061 Astro 1968
ISTS 073 Astro 1969	Johnston Island 1961	Kandawala
Kerguelen Island 1949	Kertau 1948	Kusaie Astro 1951
L. C. 5 Astro 1961	Leigon	Liberia 1964
Luzon	M'Poraloko	Mahe 1971
Massawa	Merchich	Midway Astro 1961
Minna	Montserrat Island Astro 1958	Nahrwan Masirah Is. Oman
Nahrwan United Arab Emirates	Nahrwan Saudi Arabia	Naparima, BWI
North American 1927	North American 1983	North Sahara 1959
Observatorio Meteorolog. 1939	Old Egyptian 1907	Old Hawaiian
Oman	Ord. Survey Great Britain 1936	Pico de las Nieves
Pitcairn Astro 1967	Point 58	Pointe Noire 1948
Porto Santo 1936	Provis. South American 1956	Provis. South Chilean 1963
Puerto Rico	Pulkovo 1942	Qatar National
Qornoq	Reunion	Rome 1940
S-42 (Pulkovo 1942)	Santo (DOS) 1965	Sao Braz
Sapper Hill 1943	Schwarzeck	Selvagem Grande 1938
Sierra Leone 1960	S-JTSK	South American 1969
South Asia	Tananarive Observatory 1925	Timbalai 1948
Tokyo	Tristan Astro 1968	Viti Levu 1916
Voirol 1874	Voirol 1960	Wake Island Astro 1952
Wake-Eniwetok 1960	WGS 84	Yacare
Zanderij		

## Appendix B - Troubleshooting

---

This troubleshooting guide is written with the assumption that the user has read and understood the relevant sections in this manual.

It is possible in many cases to solve difficulties without having to send the display unit back to the manufacturer for repair. Please follow this troubleshooting section before contacting the nearest Northstar dealer.

There are no user serviceable parts. Specialized methods and testing equipment are required to ensure that the display unit is reassembled

correctly and is waterproof. Users who service the product themselves will void the warranty.

Repairs to the product may only be carried out by a service centre approved by Northstar. If the product must be sent into a service centre for repair, it is essential to send in the transducer(s) at the same time.

More information can be found on our Website: [www.northstarnav.com](http://www.northstarnav.com).

### B-1 General Problems

---

#### 1-1 The EXPLORER won't turn on:

- a The EXPLORER is designed to operate on a 12/24 volt battery system, where the voltage may vary from 10.5 to 32 volts. If an excessive voltage is supplied, a fuse will be tripped, turning the display unit off. Check the fuse.
- b Check that the power cable connector at the back of the display unit is securely plugged in and the collar is locked in place. The collar must be secure for watertight connection.
- c Measure the battery voltage while the battery is under load - turn on some lights, radio or other electrical equipment connected to the battery. If the voltage is less than 10 volts:
  - the battery terminals or wiring on the terminals may be corroded.
  - the battery may not be charging correctly or may need replacing.
- d Inspect the power cable from end to end for damage such as cuts, breaks, squashed or trapped sections.
- e Ensure that the red wire is connected to the positive battery terminal and the black wire to the negative battery terminal. If wired for the Auto Power option, ensure the yellow wire is connected to the ignition circuit. Also check the boat's main switch circuit (see section 15-4).

- f Check for corrosion on the power cable connector and clean or replace if required.
- g Check fuses that are placed in line with the power cable. A fuse can be blown despite appearing to be good or the fuse may be corroded. Test the fuse or replace it with a fuse known to be good.

#### 1-2 The EXPLORER won't turn off:

The EXPLORER may have been wired for Auto power. In this case, the EXPLORER cannot be turned off while the ignition power is on (see section 2-3).

#### 1-3 If the EXPLORER beeps when turned on but nothing is displayed:

The EXPLORER may be operating, but the backlight settings may have been set too low (see section 2-4).

#### 1-4 The wrong language is displayed:

See section 14-1.

## B-2 GPS navigation problems

---

### 2-1 No GPS fix or long time to get fix at startup:

- May occur occasionally if the antenna does not have a clear view of the sky. The satellite positions are constantly changing.
- Antenna cable not connected to display unit.
- Restart the GPS (see section 14-3).

### 2-2 EXPLORER GPS position different from true position by more than 10 m (33 ft):

- EXPLORER in simulate mode. Turn simulate mode off (see section 14-11).
- The normal error in GPS position will exceed 10 m (33 ft) for about 5% of the time.
- Under special circumstances the US Department of Defence may introduce a deliberate and changing error in the GPS positions of up to 300 m (1000 ft).

### 2-3 EXPLORER position different from same position on local charts:

- EXPLORER in simulate mode. Turn simulate mode off (see section 14-11).
- Incorrect chart datum. Select the correct chart datum (see section 14-2).
- Map shift has been applied wrongly. Clear map shift, then reapply if necessary (see section 14-2).

### 2-4 Can not see boat on chart:

- Press **ESC** to switch to centre on boat mode (see section 3-2-1).

### 2-5 The time or date on satellite display is wrong or off:

- No GPS fix.
- In simulate mode. Turn simulate mode off (see section 14-11).
- Local time offset is wrong (see section 14-10). The Local Time Offset must be changed when daylight saving time starts or ends.

### 2-6 Autopilot not responding to EXPLORER; no NMEA output:

- NMEA output disabled or the required NMEA sentences are not turned on. Check NMEA settings (see section 14-9).
- Check that the instrument is connected correctly.

### 2-7 No DGPS fix or loss of DGPS fix:

- To receive a DGPS fix, WAAS/EGNOS must be enabled or an optional DGPS antenna fitted (see section 7).
- With WAAS/EGNOS: Boat out of coverage area (see section 7).
- With WAAS: GPS antenna does not have a clear view of the horizon towards the equator.
- With beacon DGPS: boat out of range of a DGPS beacon.

## B-3 Fuel consumption problems

---

### 3-1 Number of engines or tanks is wrong

Check that the number of engines and tanks is correct (see section 14-4).

### 3-2 Fuel flow(s) seem inaccurate:

- a Check that the fuel setup data is correct (see section 14-4).
- b Check that the fuel cable connectors are securely plugged in and the collar is locked in place. Check the fuel cable is not damaged or pinched.
- c A fuel sensor may be blocked.  
A fuel filter must be installed between the fuel transducer and the fuel tank as described in the sensor installation manual. Otherwise the warranty is void.
- d Recalibrate the fuel flow sensor(s) (see section 10-7).
- e Check that the fuel filter is clean.
- f In rough seas, fuel may surge back and forth through the fuel sensor(s), resulting in incorrect readings. Try installing a one-way valve between the fuel sensor(s) and the fuel tank.
- g Petrol/gasoline fuel sensors should be replaced after every 5000 litres of fuel.

### 3-3 Fuel remaining seems inaccurate:

- a The EXPLORER is not wired for auto power (see section 15-4).
- b You added or removed fuel but did not tell the EXPLORER (see section 10-3).
- c The fuel tank may not refill to the same capacity each time due to air pockets. This is a particular problem with underfloor tanks.

### 3-4 Erratic fuel flow readings:

- a The Flow filter value is not suitable for the engine. Check that the value is not set to zero, then try increasing the value until a steady flow rate is shown (see section 14-4).
- b The fuel flow sensor(s) may be too close to the fuel pump or may be subject to excessive vibration. Refer to the fuel sensor installation manual.
- c Check for leaks in the fuel line or in the fuel pickup in the tank.

### 3-5 There is no reading for fuel economy:

- a The boat must be travelling through the water to have a reading.
- b If you selected a paddlewheel sensor (see section 10-5-1), check that the paddlewheel spins freely.



## Appendix C - Glossary and navigation data

---

### Glossary

---

**Attention Area** - An important area on a chart, such as a restricted anchorage or a shallow area (see section 14-2).

**Bathymetric line** - A depth contour line on the chart.

**Chart card** - A plug-in card that stores chart data for a region (see section 1-3).

**C-MAP™ chart card** - See Chart card.

**C-MAP™ user card** - See User card.

**Cursor** - A  $\dagger$  symbol on the display (see section 3-2).

**DGPS** - Differential Global Positioning System. A navigation tool based on GPS with some errors corrected (see section 7).

**Goto** - A simple way of navigating straight to a waypoint or to the cursor position (see section 3-1).

**GPS** - Global Positioning System. A satellite-based navigation tool (see section 7).

**Leg** - The straight segments of a route between waypoints. A route with four waypoints has three legs.

**MOB** - Man overboard.

**MOB function** - Starts navigating back to the place where someone fell overboard (see section 2-5).

**NavBus** - A way of connecting Northstar instruments together to share data (see section 15-8).

**NMEA** - National Marine Electronics Association.

**NMEA 0183** - A standard for interfacing marine electronic devices (see section 15-9).

**Route**: Two or more waypoints linked in sequence to form a course for the boat (see section 6).

**User card** - A plug-in card that stores waypoints, routes and tracks (see section 12).

**UTC** - Universal Time Coordinated or Coordinated Universal Time, which is a standard world time, formerly called Greenwich Mean Time (GMT).

**Waypoint** - A position that you can set on the EXPLORER chart, for example a fishing spot or a point on a route (see section 5).

## Navigation data

The boat is sailing from the start to the destination and has moved off the plotted course from the start to the destination.

**BRG** Bearing to Destination: Bearing to the destination from the boat.

**†BRG** Bearing to cursor: Bearing to cursor from boat (cursor mode, see section 3-2)

**CDI** Course Deviation Indicator: When the boat is navigating to a point, the chart and highway displays show a parallel line on either side of the plotted course. These two lines are called the Course Deviation Indicator (CDI) lines. The distance from the plotted course to a CDI line is the CDI scale.

Set the CDI scale (see section 14-2) to the maximum distance that the boat should deviate from the plotted course. The chart and highway displays show the CDI lines, which are like a highway over the water where the boat will move. The displays show how far the boat has deviated from the plotted course and if the boat is approaching a CDI line. If the XTE alarm is enabled (see section 14-7) an alarm will sound if the boat reaches a CDI line.

**COG** Course Over Ground: Direction in which the boat is moving over the ground.

**CTS** Course To Steer: Optimum course to steer to return to the plotted course.

**DTG** Distance To Go: Distance from the boat to the destination.

**ETA** Expected Time of Arrival: At the destination, assuming that SOG and COG remain constant.

**†RNG** Range to cursor: Distance from boat to cursor (cursor mode, see section 3-2)

**SOG** Speed Over Ground: Current boat speed over the ground. This is not necessarily the same as the boat speed through the water nor the speed at which it is approaching the destination.

**STR** Steering: The difference between COG and CTS.

**TTG** Time To Go: The estimated time to reach the destination.

**XTE** Cross Track Error: The distance from the boat to the nearest point of the plotted course. XTE may have a letter: R means steer to the right to return to the plotted course, L means steer to the left.

**VMG** Velocity Made Good: The speed at which the boat is approaching the destination.

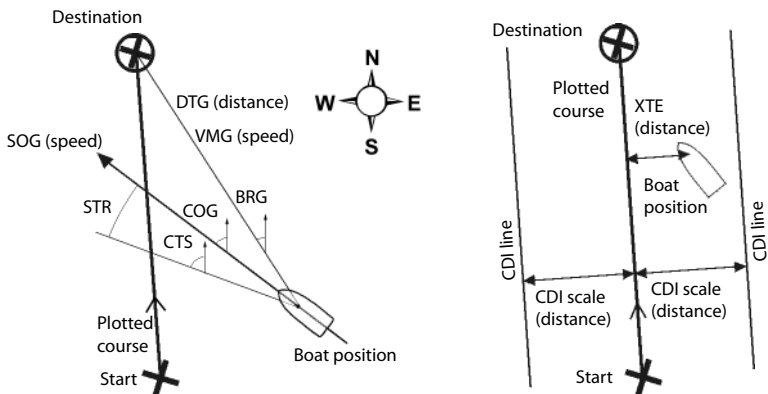



**USA**

30 Sudbury Road,  
Acton, MA 01720, USA  
Ph: +1 978.897.6600  
Fax: +1 978.897.7241  
sales@bntmarine.com

**EUROPE**

Unit 2, Ocean Quay,  
Belvidere Rd, Southampton,  
SO14 5QY, ENGLAND  
Ph: +44 2380 339922  
Fax: +44 2380 330345  
northstaruk@northstarnav.com

**AUSTRALIA**

PO Box 479,  
Gladesville, NSW 2111,  
AUSTRALIA  
Ph: +61 2 9879 9000  
Fax: +61 2 9879 9001  
northstaraus@northstarnav.com

**NEW ZEALAND**

PO Box 68 155,  
Newton, Auckland  
Auckland, NEW ZEALAND  
Ph: +64 9 481 0500  
Fax: +64 9 481 0590  
northstarnz@northstarnav.com

[www.northstarnav.com](http://www.northstarnav.com)

**NORTHSTAR** 



Made in New Zealand  
MN000595A-G