

## Installation Guide

Please read this document before using the product, and save this document for future reference. **Panasonic Network Camera Website:** <http://panasonic.net/pcc/ipcam/>

### Network Camera (PoE Ready)

Model No. **BB-HCM511A**  
**BB-HCM531A**

Indoor Use Only

Outdoor Ready

This manual is written for both the BB-HCM511A (Indoor Use Only) and the BB-HCM531A (Outdoor Ready). Available features and operations vary slightly depending on the model. You can confirm the model no. of your camera by checking the model no. printed on the front of the camera.

**Please read the included Important Information before proceeding.**

**Complete Operating Instructions and all other documentation can be found on the included CD-ROM.**

- This document (Installation Guide) explains how to physically connect the camera to the power supply and network, as well how to mount or place the camera for regular use.
- The **Setup Guide** describes how to set up the camera so that it can be accessed using a PC.
- Refer to the **Operating Instructions** on the **CD-ROM** for details regarding the camera's features.
- Refer to the **Troubleshooting Guide** on the **CD-ROM** if you have any problems configuring or using the camera.
- The illustrations used in Installation Guide are of BB-HCM531A.

### Abbreviations

- UPnP is the abbreviation for "Universal Plug and Play".
- The Network Camera is referred to as "the camera" in this document.
- The Setup CD-ROM is referred to as "the CD-ROM" in this document.





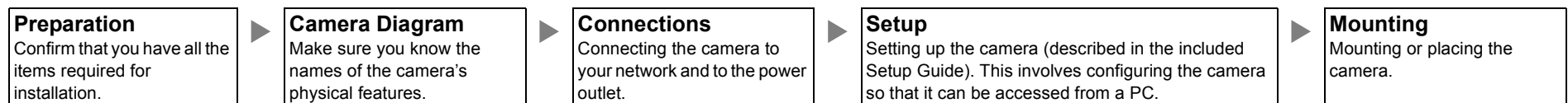







### Installation Procedure Overview

The following is an overview of the steps required to install and setup the camera. All steps are explained in this document unless otherwise noted.

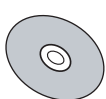
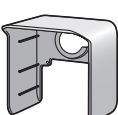

### Preparation

- Confirm the following items are included in the camera's packaging.
  - Additional pieces can be ordered by calling 1-800-332-5368.

 <b>Main Unit (1 pc.)</b>	 <b>Washer S (1 pc.)</b> <b>Order No. XWG26D12VW</b> Used when securing the safety wire to the camera.	 <b>Screw A</b> <b>BB-HCM511A (1pc. for the safety wire)</b> <b>Order No. PQHV2610PJ65</b> <b>BB-HCM531A (1pc. for the safety wire, 4pcs. for the connector cover)</b> <b>Order No. XTN26+10GVW</b>
 <b>Flexible Stand (1 pc.)</b> <b>Order No. PQKL1008Z1</b>	 <b>Washer L (1 pc.)</b> <b>Order No. XWG4F16VW</b> Used when securing the safety wire to the ceiling or wall.	 <b>Screw B (1pc. for the safety wire, 3pcs. for the flexible stand)</b> <b>Order No. XTB4+20AFJ</b>
 <b>Safety Wire (1 pc.)</b> <b>Order No. PQME10080Z</b> Used to secure the camera when mounting it.	 <b>Important Information (1 pc.)</b> <b>Installation Guide (this document) (1 pc.)</b> <b>Setup Guide (1 pc.)</b>	 <b>Setup CD-ROM (1 pc.)</b> <b>Order No. PNQC1048Z</b> Contains the Setup Program needed to configure the camera, as well as the camera's documentation.* *See the included Important Information for a description of each document.
 <b>Sunshade (1pc.)</b> <b>[BB-HCM531A Only]</b> <b>Order No. PQKV10074Z1</b>	 <b>Connector Cover (1pc.)</b> <b>[BB-HCM531A Only]</b> <b>Order No. PQYCHCM531A</b>	 <b>Foam Strip (1pc.)</b> <b>[BB-HCM531A Only]</b> <b>Order No. PQHG10748Z</b>
		 <b>Self Bonding Tape (1pc.)</b> <b>[BB-HCM531A Only]</b> <b>Order No. PSHG1235Z</b>

- You will need the following additional items to install and configure the camera.
  - a PC (see the system requirements in the Important Information document)
  - a router
  - a LAN cable (CAT-5 straight cable)

### Option

You can also connect the camera using the optional Panasonic BB-HCA3A AC Adaptor. The BB-HCA3A includes the following items.

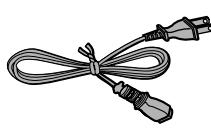
 <b>AC Adaptor (1 pc.)</b> <b>Cord Length: About 3 m (9 feet 10 inches)</b>	 <b>AC Cord (1 pc.)</b> <b>Cord Length: About 1.8 m (5 feet 11 inches)</b>
---	--

- The AC adaptor, the AC adaptor cord, and the AC cord are not waterproofed, and are intended for indoor use only. The AC adaptor, the AC adaptor cord, and the AC cord must be waterproofed for outside use.

### Camera Diagram

#### Front View

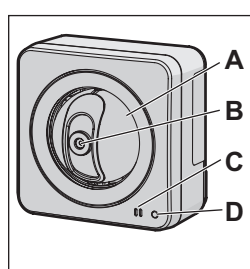

- A Lens cover
- B Lens
- C Microphone
- D Indicator\*1

#### Side and Bottom View

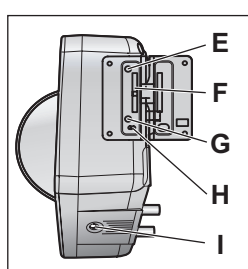

- E FACTORY DEFAULT RESET button
- F SD memory card slot
- G RESTART button
- H FUNCTION button/indicator
- I Stand/tripod mounting hole

#### Rear View

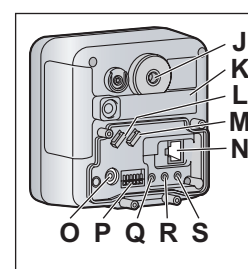

- J Stand mounting hole
- K Serial number and MAC address label
- L AC adaptor cord/video cable hook
- M Speaker/microphone cable hook
- N LAN port
- O DC IN
- P External I/O interface
- Q VIDEO OUT terminal
- R AUDIO OUT terminal
- S MIC terminal

\*1 See 1.1 Understanding the Camera Indicator in the Troubleshooting Guide on the CD-ROM for indicator meaning.

## Connections

Before proceeding, confirm that your PC is connected to your router and can access the Internet. Also confirm that your router's UPnP™ feature is enabled. (Most routers have UPnP™ turned off by default.) Refer to the operating instructions included with your router or to the Panasonic Network Camera website (<http://panasonic.net/pcc/ipcam/>) for more information.

### When connecting the camera using PoE (Power over Ethernet)

Connect the camera to your PoE hub using a LAN cable (Cat-5 straight cable) as described below.

- ① Connect a LAN cable to the camera and to the PoE hub.
  - Your PoE hub must be connected to the router. Refer to the operating instructions included with the PoE hub for connection instructions.
  - The lens will pan and tilt when the camera is turned on.
- ② Connect a LAN cable to a LAN port of the PoE hub and to a LAN port of the router.
  - Confirm that the indicator lights green after about 1 minute. If the indicator does not light green, see 1.2 Camera Indicator Issues in the Troubleshooting Guide on the CD-ROM.

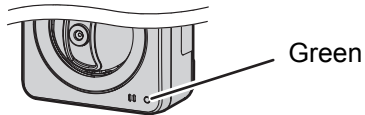

- When the lens pans or tilts, a sound can be heard from the camera. This is normal.
- Use a 4-pair UTP/STP cable.
- Do not use a relay connector or a hub between the camera and the PoE hub. These devices may disturb the data or electricity transmission.
- If the PoE hub has indicators, the indicator lights as shown in the table below.

Indicator	Description
LINK	Turns on when the data is transmitted from the camera.
PoE	Turns on when the electricity is supplied to the camera.

- If the PoE hub is turned off or power supply is temporarily cut off by the disconnection of the LAN cable, it may take time for the PoE hub's indicators to light.
- The indicator display differs depending on manufacturers, refer to the manuals of the PoE hub.

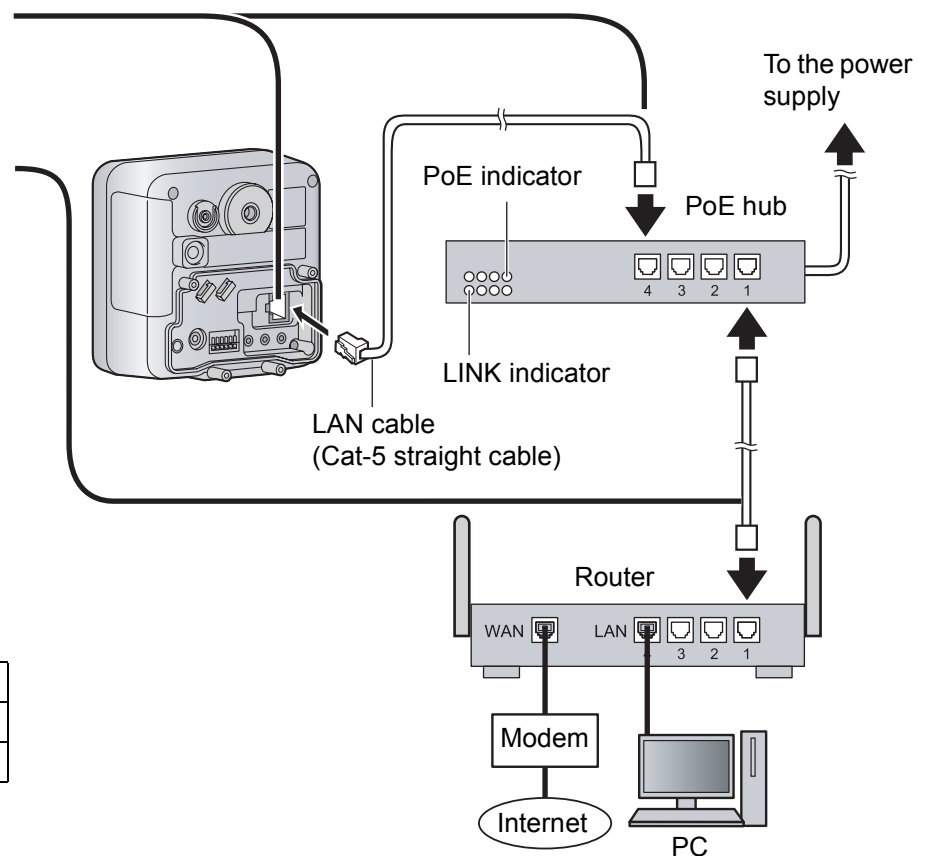

### When connecting the camera using the BB-HCA3A AC Adaptor (Optional)

Connect the camera to your router and to the power outlet as described below.

- ① Connect the LAN cable to the camera and the router.
- ② Connect the AC adaptor cord to the DC IN jack.
- ③ Connect the AC cord to the AC adaptor, then plug the AC cord into the power outlet.
  - The lens will pan and tilt when the camera is turned on.
  - Confirm that the indicator lights green after about 1 minute. If the indicator does not light green, see 1.2 Camera Indicator Issues in the Troubleshooting Guide on the CD-ROM.

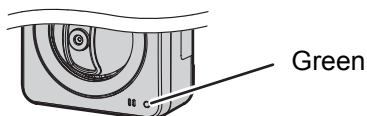

- When you operate the camera, the power outlet should be near the camera and easily accessible.
- Use only specified Panasonic AC adaptor (Model No. BB-HCA3A).
- When the lens pans or tilts, a sound can be heard from the camera. This is normal.

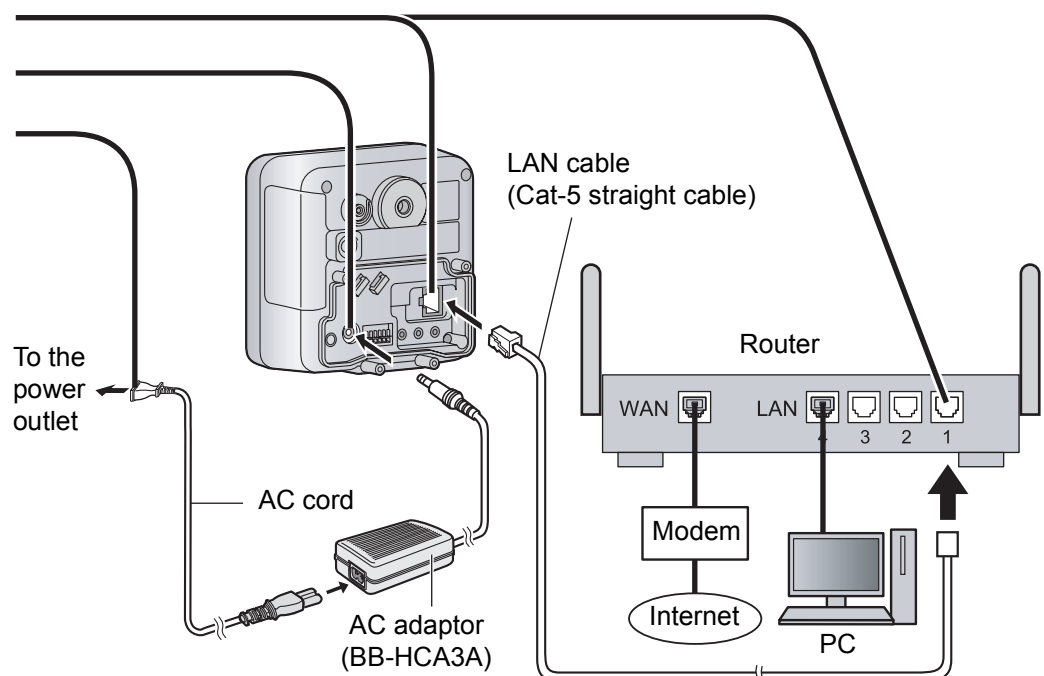

**After the camera's indicator turns green, you may set up the camera. Continue by following the procedure described in the included Setup Guide.**

- If the indicator does not turn green, see 1.2 Camera Indicator Issues in the Troubleshooting Guide on the included CD-ROM.

**After setting up the camera according to the procedure described in the Setup Guide, read the following information.**

### Connecting External Audio Devices

You can connect an external microphone and external speaker to the camera to use the Listen and Talk features, respectively. For information about these features, see 1.2.9 Audio Features in the Operating Instructions on the CD-ROM. Connect the devices as shown below.

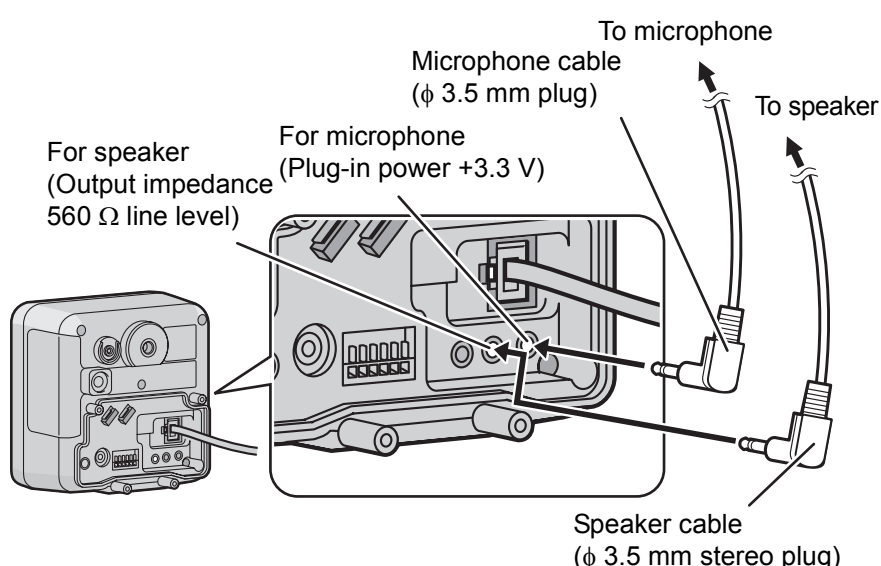

#### Note

- If you use an external microphone, excessive cable length or a poor quality cable can cause degradation in audio quality.
- The microphone cable should be no longer than 7 m (23 feet).
- Use a speaker with a built-in amplifier. The speaker connects to the camera with a stereo audio cable similar to that used by your PC. The output signal is mono.
- Make sure the camera and speaker are turned off when connecting or disconnecting the speaker cable, otherwise noise may be heard from the speaker.
- The external microphone input does not correspond to a line level. Audio may be distorted when the line level is input. Audio distortion will be solved if you insert the following circuits. Under no circumstance should high-level audio, such as from a speaker, be connected to this input terminal. Doing so is likely to damage the camera.

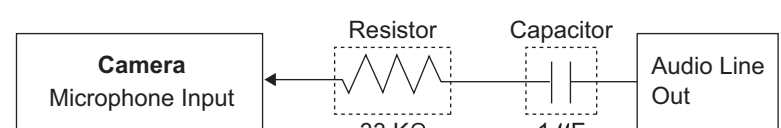

## Connecting a Video Device

You can connect a TV or other video device (NTSC or PAL format) to the camera to monitor or record camera images. Connect the video device as shown below.

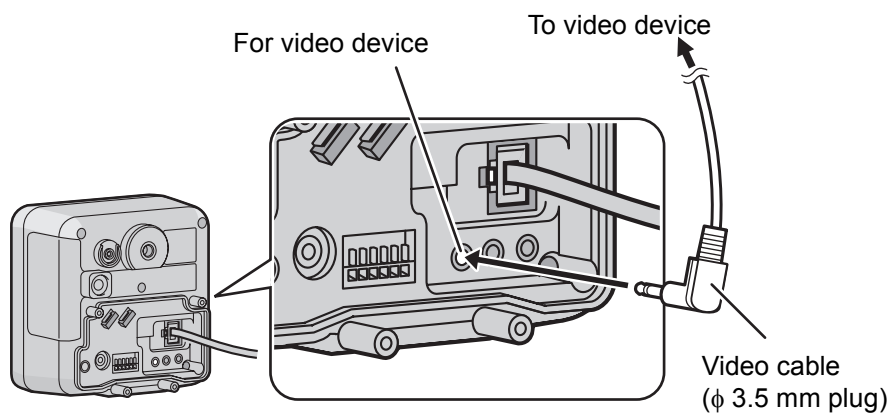

### Note

- Analog video output is disabled by default. See 7.5 Controlling the Analog Video Output Signal in the Operating Instructions on the CD-ROM for more information.

## Connecting External Sensors

The camera's external I/O interface allows you to connect 2 devices (such as sensors, motion detectors, etc.) that can be used to trigger the camera's image buffering and transferring features (see Section 2 Using Triggers to Buffer and Transfer Images in the Operating Instructions on the CD-ROM). The external I/O interface has 6 terminals.

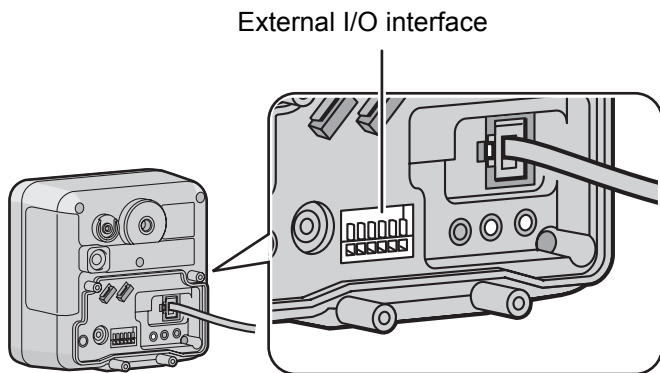

### Circuit Diagram Example

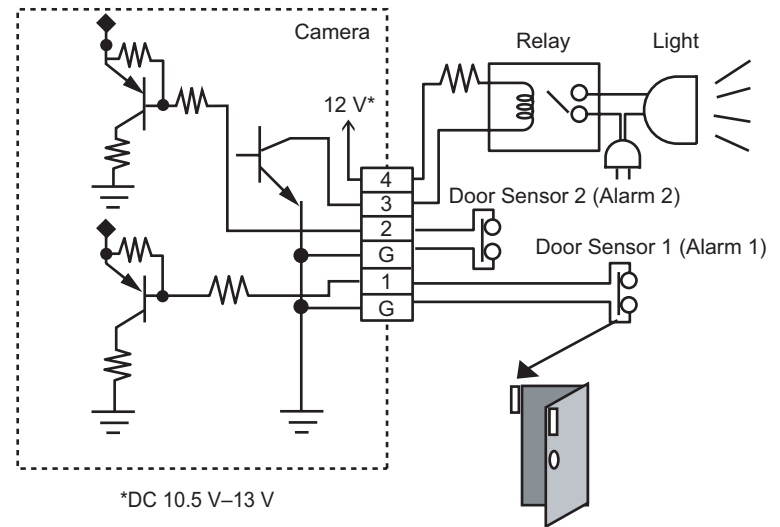

\*DC 10.5 V–13 V

### Caution

- The external I/O interface is not capable of connecting directly to devices that require large amounts of current. In some cases, a custom interface circuit (customer-provided) may have to be used. Serious damage to the camera may result if a device that exceeds its electrical capability is connected to the external I/O interface.
- Low voltage/current circuits and high voltage/current circuits are used in the camera circuit. All wiring should be performed by a qualified electrician. Incorrect wiring could damage the camera and cause a fatal electric shock.
- External devices connected to the camera's output terminals cannot be controlled in the event of a network error or failure. Keep this in mind when connecting door locks, heat-emitting devices, or other devices that may be dangerous if they cannot be controlled.

Terminal	Description
G	GND terminal.
1	External sensor input 1. The camera can be triggered by either an open circuit or a GND short-circuit.
G	GND terminal.
2	External sensor input 2. The camera can be triggered by either an open circuit or a GND short-circuit.
3	External device control output. Allows you to control an external device using the output buttons in the camera's operation bar (for example, turning a light on or off). <ul style="list-style-type: none"> <li>• This terminal's behavior can be changed (see 7.4 Controlling the External Output Terminal in the Operating Instructions on the CD-ROM).</li> <li>• This terminal is an open collector circuit. The maximum drawing current is the same as terminal 4. Do not exceed the voltage of the terminal 4.</li> </ul>
4	DC power output terminal. <ul style="list-style-type: none"> <li>• 10.5–13 V DC</li> <li>• Maximum load drive is 100 mA.</li> </ul>

### Note

- Do not push strongly on the external I/O interface with the pointed object. The external I/O interface may get stuck into the unit, and you may not be able to use it.

## Mounting the Camera

Three mounting methods are available, as shown here. Confirm which side is the top and bottom of the camera when mounting; do not mount the camera upside down. Consult an authorized dealer for mounting.

### Caution

- Do not drive the screws into a soft material. Drive the screws into a secure area of the wall or ceiling, such as a column, otherwise the camera may fall and be damaged.
- Make sure you attach the safety wire when mounting the camera, to prevent the camera from falling.

### Note

- **For BB-HCM511A:** The camera is intended for indoor use only and should not be mounted outdoors.
- **For BB-HCM531A:** If you install the camera outdoors, the external microphone or speaker must be outdoor compatible.
- Use screws that are appropriate for the material of the wall or ceiling.
- The included screws are for use with wooden walls or ceilings only.
- To ensure that camera images are displayed properly, do not mount the camera on an incline. Mount the camera so that it is perpendicular to the floor. Do not mount the camera upside down.
- Mounting and cabling instructions described in this document follow generally accepted guidelines suitable for residential installations. In some areas, commercial and industrial installations are regulated by local or state ordinances. For such installations, contact your local building department or building inspector for more details.
- Camera images can be viewed in relatively dark areas, however, image quality decreases when viewing dark images. We recommend using supplemental lighting for best results.
- Prolonged exposure to direct sunlight or halogen light may damage the camera's image sensor. Mount the camera appropriately.
- When mounting the camera, make sure to wrap the AC adaptor cord (if used) and other cables (external microphone or speaker cable, video cable, etc.) around the hooks as shown to ensure secure connections.

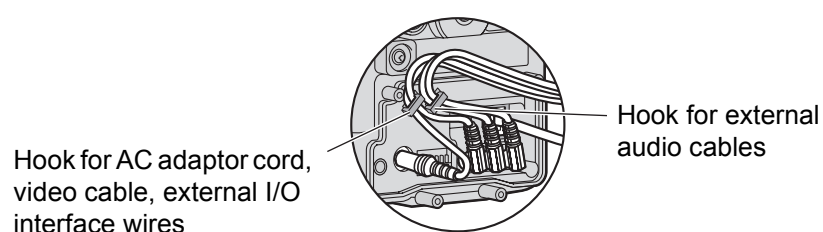

Hook for AC adaptor cord, video cable, external I/O interface wires

Hook for external audio cables

## Flexible Stand Mount

1. Screw the threaded mount into the stand/tripod mounting hole.
2. Turn the grip firmly.

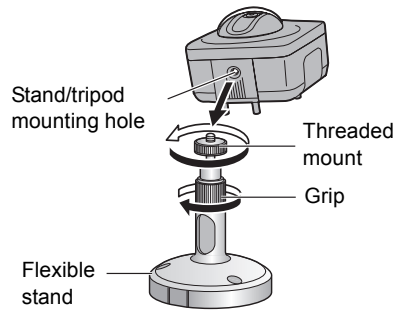

## Tripod Mount

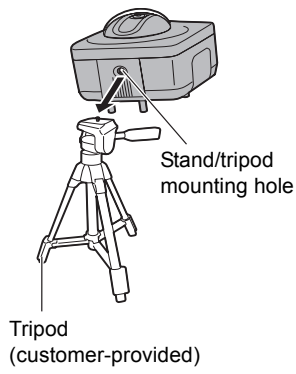

## Ceiling/Wall Mount

### Wiring without making a hole for a cable in the ceiling or wall

#### For BB-HCM531A:

Before following the procedures below, we recommend passing all cables (AC adaptor, LAN, audio/video, etc.) through a duct (i.e., hose, tube, etc.) for proper waterproofing.

1. Secure the safety wire to the camera using screw A (included) and washer S (included).
  - Make sure you attach the safety wire when mounting the camera, to prevent the camera from falling.

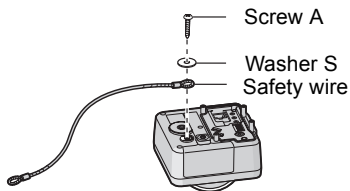

2. Remove the tab on the flexible stand. Then pass the cables through the notch.

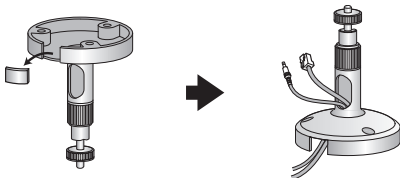

#### 3. For BB-HCM511A:

Connect all necessary cables (AC adaptor, LAN, audio/video, etc.). Then skip to step 7.

#### For BB-HCM531A:

Pass the cables through the connector cover, and then connect all necessary cables (AC adaptor, LAN, audio/video, etc.). Attach the connector cover by fastening the two screws.

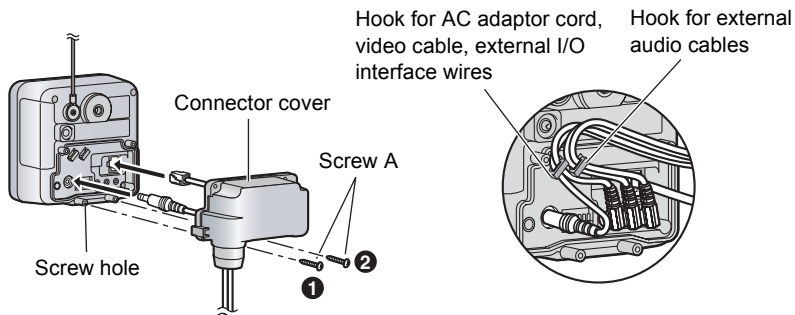

4. Attach the sunshade by fastening the two screws.

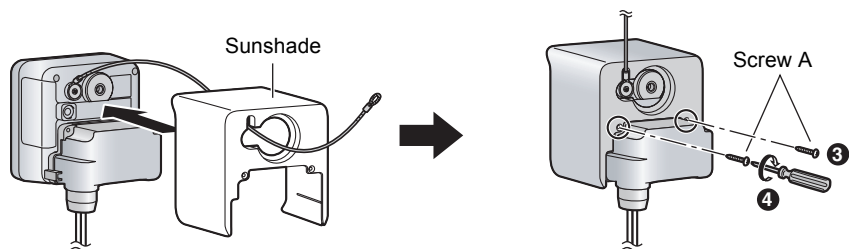

5. Wrap the cables in the included foam strip and insert the foam strip into the opening of the connector cover.
  - Leave about 10 mm (3/8 inches) of the foam exposed, as shown.

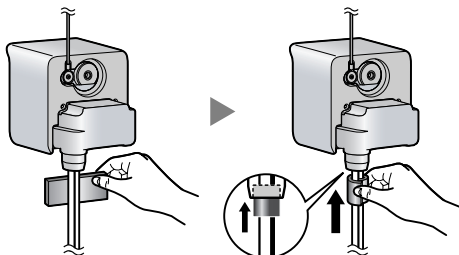

6. Wrap the first 20 cm (7 7/8 inches) of the cables (starting with the connector cover) using the included self bonding tape. Make sure to wrap the opening of the connector cover thoroughly (three or four times).
  - Stretch the tape to twice its length when you wrap the cables.
  - Overlap the tape when you wrap the cables.

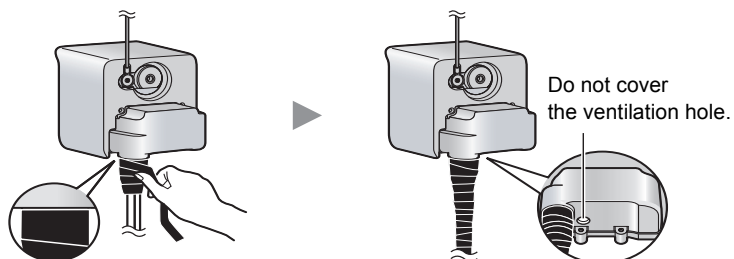

7. Attach the camera by screwing the threaded mount into the stand mounting hole.

#### ■ Ceiling

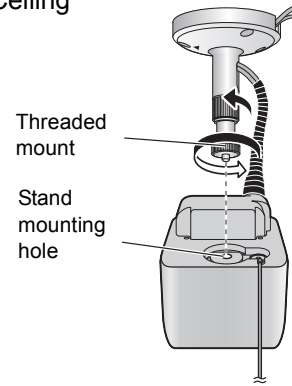

#### ■ Wall

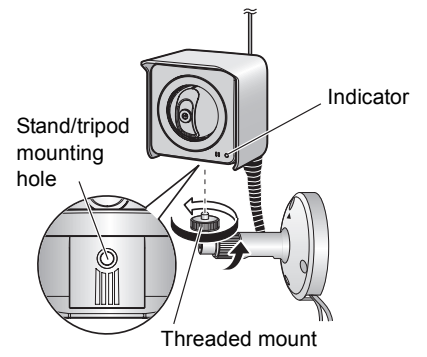

8. Mount the flexible stand firmly to the ceiling or wall with screw B (included).

- Do not drive the screws into a soft material. Drive the screws into a secure area of the wall, such as a column, otherwise the camera may fall and be damaged.
- Use screws that are suited for the type of material the camera is mounted to.
- Be careful not to nip the cables.
- Make sure the flexible stand is firmly mounted on a beam of wood (25 mm [1 inch] and greater) etc. When there is no beam, apply a board on the other side of the ceiling or wall to make sure the camera does not drop.

#### ■ Ceiling

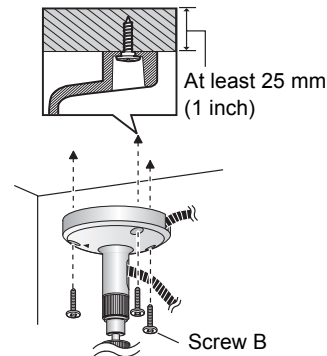

#### ■ Wall

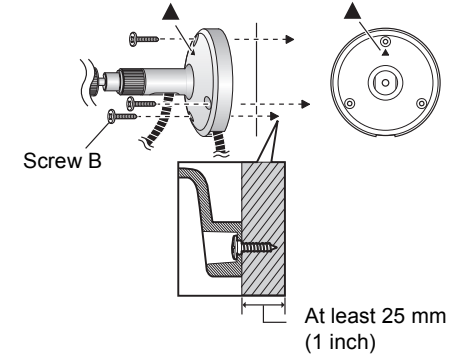

9. Adjust the camera position and tighten the flexible stand grip firmly.

- Confirm that the cords have been waterproofed and that the portion of the cord protruding from the flexible stand is wrapped in self bonding tape, as shown in (A) below.

#### ■ Ceiling

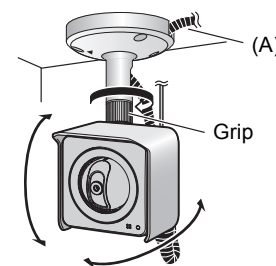

#### ■ Wall

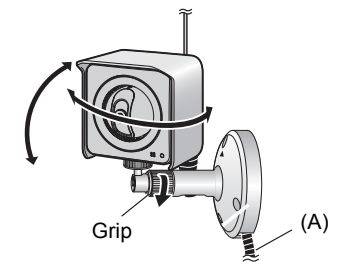

10. Secure the safety wire to the ceiling or wall using screw B (included) and washer L (included).

- Leave some slack in the safety wire, as shown.
- Make sure the safety wire is firmly mounted on a beam of wood (25 mm [1 inch] and greater) etc. When there is no beam, apply a board on the other side of the ceiling or wall to make sure the camera does not drop.
- Make sure to waterproof the opening of the duct so that water does not enter it.

#### ■ Ceiling

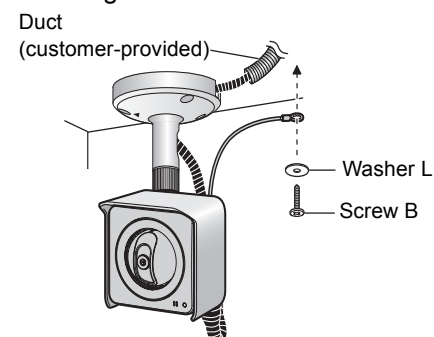

#### ■ Wall

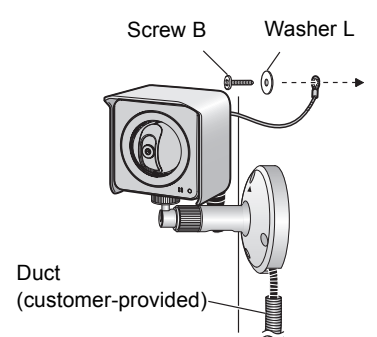

### For BB-HCM511A (INDOOR USE ONLY): Wiring through a hole made in the ceiling or wall

Make a hole for cables in the ceiling or wall. Secure the safety wire to the camera and pass the cables through the notch. Then follow steps 7, 8, 9 and 10.

#### ■ Ceiling

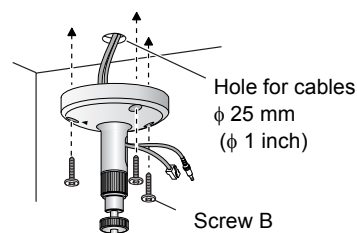

#### ■ Wall

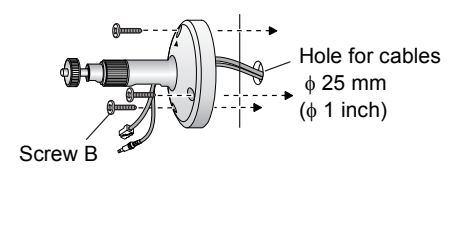

### When mounting on a mortar or concrete surface

- Prepare anchors for 4 mm (3/16 inch) diameter screws for mounting.

1. Place the flexible stand on the ceiling or wall where you plan to mount the flexible stand and mark the points where you are going to make holes.
2. Make holes with an electric drill. Insert anchors (customer-provided) into the holes and push them inside the holes with a hammer.
  - Mortar ceilings or walls break easily when drilling. Be careful of pieces of mortar which may become loose and fall.

Drill for concrete (in case of tile, use a drill for tile)

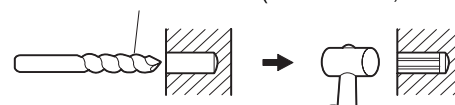

3. Mount the flexible stand using the screws.