

# Panasonic

## Network Camera

### Network Operating Instructions

Model No. **WV-NF284**



Before attempting to connect or operate this product,  
please read these instructions carefully and save this manual for future use.

No model number suffix is shown in this manual.

# CONTENTS

|   |    |
|---|----|
| Preface .....   | 3  |
| About these operating instructions .....  | 3  |
| Trademarks and Registered Trademarks .....  | 3  |
| Viewer Software .....   | 3  |
| Monitor Images on a PC .....  | 4  |
| Monitor images from a single camera .....   | 4  |
| Monitor images from multiple cameras .....  | 7  |
| Action at an Alarm Occurrence .....   | 8  |
| Transmit Images onto an FTP Server .....  | 9  |
| Transmit an alarm image at an alarm occurrence<br>(Alarm image FTP transmission) .....                              | 9  |
| Transmit images at a designated interval or period (FTP periodic transmission) .....                                | 9  |
| Save images on the SD memory card when failed to transmit images by the<br>FTP periodic transmission function ..... | 10 |
| About the network security of this unit .....   | 12 |
| Equipped security functions .....   | 12 |
| Display the Setup Menu and Configure the Settings of the Camera using a PC .....                                    | 13 |
| How to display the setup menu .....   | 13 |
| How to operate the setup menu .....   | 14 |
| Configure the basic settings of the camera [Basic setup] .....  | 17 |
| Configure the settings relating to images and audio [Camera setup] .....  | 21 |
| Configure the multi-screen settings [Multi-screen setup] .....  | 26 |
| Configure the alarm settings [Alarm setup] .....  | 27 |
| Configure the settings relating to the authentication [Authentication setup] .....                                  | 34 |
| Configure the settings of the servers [Server setup] .....  | 36 |
| Configuring the network settings [Network setup] .....  | 38 |
| Maintenance of the camera [Maintenance] .....   | 46 |
| About the Displayed System Log .....  | 49 |
| Troubleshooting .....   | 51 |

# Preface

---

## About these operating instructions

There are 2 sets of operating instructions for the WV-NF284 as follows.

- Installation Guide
- Network operating instructions

These network operating instructions contain descriptions of how to operate this product using a PC via a network and of how to configure the settings.

Refer to the installation guide for descriptions of how to install this product and of how to connect to a network.

Adobe® Reader is required to read PDF. When the Adobe® Reader is not installed on the PC, download the latest Adobe® Reader from the Adobe web site and install it.

## Trademarks and Registered Trademarks

- Microsoft, Windows, Internet Explorer, ActiveX and DirectX are either registered trademarks or trademarks of Microsoft Corporation in the United States and/or other countries.
- Adobe and Reader are either registered trademarks or trademarks of Adobe Systems Incorporated in the United States and/or other countries.
- SD logo is a trademark.
- Other names of companies and product contained in these operating instructions may be trademarks or registered trademarks of their respective owners.

## Viewer Software

- Images will not be displayed when the viewer software "Network camera View3" is not installed on the PC. Install the viewer software from the provided CD-ROM.
- The viewer software used on each PC should be licensed individually. Refer to your dealer for the software licensing.

# Monitor Images on a PC

The following are descriptions of how to monitor images from the camera on a PC.

## Monitor images from a single camera

### Step 1

Start up the web browser.

### Step 2

Enter the IP address designated using the Panasonic IP setup software in the address box of the browser.

Example: `http://192.168.0.10/`

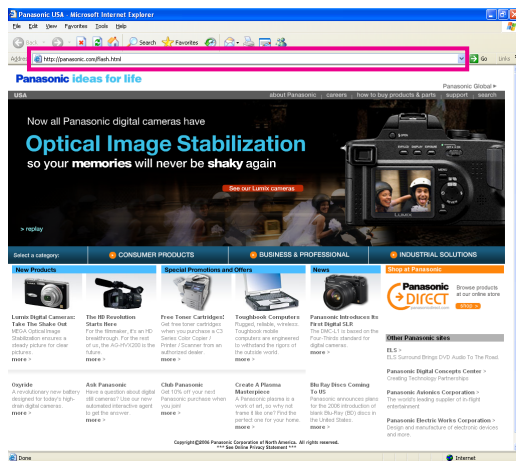

### Important:

- When the HTTP port number is changed from "80", enter "`http://IP address of the camera + (: colon) + port number`" in the address box of the browser, for example, "`http://192.168.0.11:8080`".
- Configure the web browser to not use the proxy server.

### Step 3

Press the [Enter] key on the keyboard.

→ The "Live" page will be displayed.

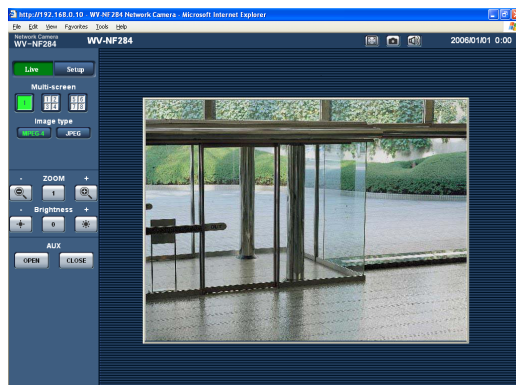

### Notes:

- When "ON" is selected for "User Authentication" (☞ page 34), the authentication window will be displayed before displaying live images for the user name and password entries. The default user name and password are as follows.  
User name: admin  
Password: 12345  
When accessing the camera without changing the default password, the pop-up window saying that it is recommended to change the password will be displayed.  
To enhance the security, change the password for the user "admin". It is recommended to change this password periodically.
- Maximum concurrent access to the camera will be limited to up to 8 users in the following case.
  - When "Unicast port (AUTO)" is selected for "Transmission type" (☞ page 22)
  - When "Unicast port (MANUAL)" is selected for "Transmission type" (☞ page 22)
  - When JPEG images are being transmitted from the camera

Depending on the set values for "Total bit rate" and "Max bit rate (per 1 client)", the maximum concurrent access number may be less than 8 users. When 8 users have been concurrently accessing already, the access limit message will be displayed for users who accessed subsequently.

- When "ON" is selected for "MPEG-4 transmission" (☞ page 22), an MPEG-4 image will be displayed. When "OFF" is selected, a JPEG image will be displayed. It is possible to display JPEG image even when "ON" is selected for "MPEG-4 transmission". In this case, the refresh interval will be limited.

### <Refresh interval (JPEG)>

- When "ON" is selected for "MPEG-4 transmission"  
JPEG (VGA): 5 fps  
JPEG (QVGA): 10 fps
- When "OFF" is selected for "MPEG-4 transmission"  
JPEG (VGA or QVGA): 30 fps

The refresh interval may be longer depending on a network environment, PC spec, photographic subject, access traffic, etc.

**Important:**

- When displaying multiple MPEG-4 images on a PC, images may not be displayed depending on the performance of the PC.
- When "ON" is selected for "VMD alarm" (☞ page 27), the frame rate of MPEG-4 images will become 15 fps at a maximum.

Refer to this page for further information about the "Live" page.

## About the "Live" page

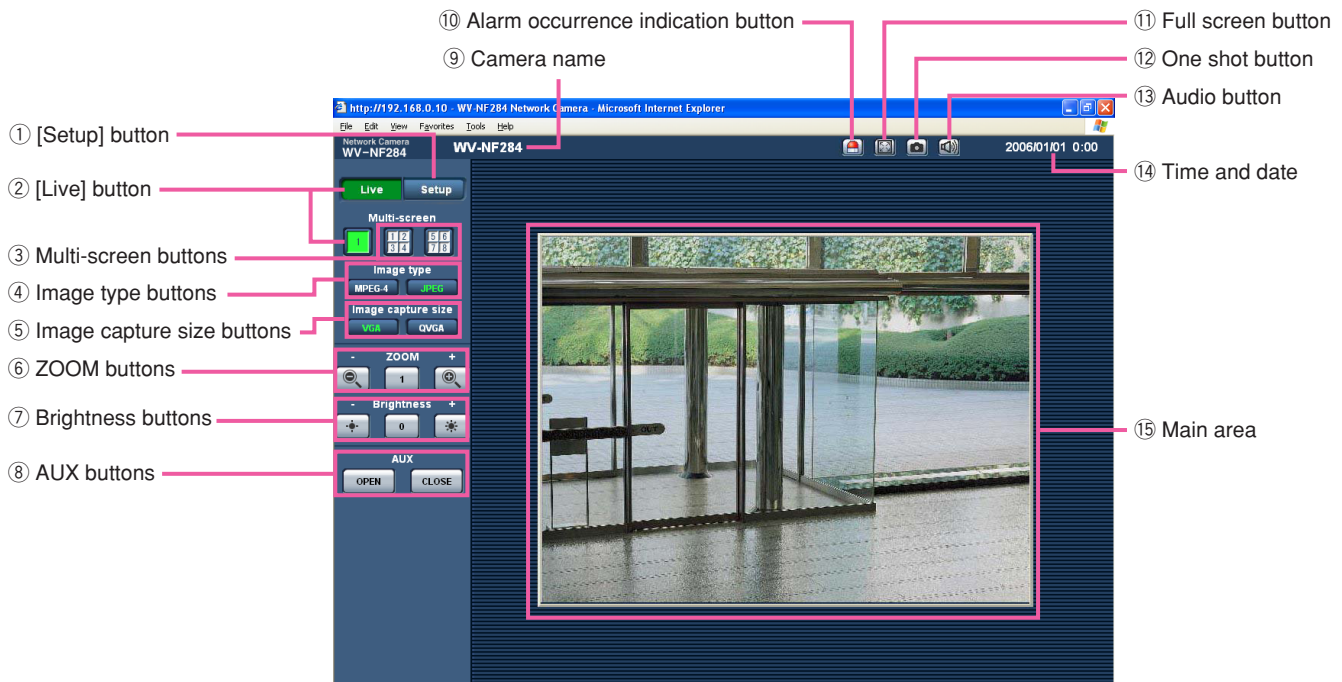

① **Setup** [Setup] button (\*1)  
Click this button to display the setup menu. The button will turn green and the setup menu will be displayed.

② **Live** [Live] button  
Click this button to display the "Live" page. The button will turn green and the "Live" page will be displayed.

③ **Multi-screen buttons**  
Images from multiple cameras can be displayed on a multi-screen by registering cameras on the setup menu. (☞ page 7)

④ **Image type buttons**  
**MPEG-4** : The letters "MPEG-4" on the button will turn green and an MPEG-4 image will be displayed. When "OFF" is selected for "MPEG-4 transmission" on the setup menu, the [MPEG-4] button will not be displayed. (☞ page 22)  
**JPEG** : The letters "JPEG" on the button will turn green and JPEG image will be displayed.

⑤ **Image capture size buttons**

These buttons will be displayed only when a JPEG image is displayed.

: The letters "VGA" on the button will turn green and images will be displayed in VGA size.

: The letters "QVGA" on the button will turn green and images will be displayed in QVGA size.

⑥ **ZOOM buttons (\*2)**

: The zoomed image will be zoomed out. (Image displayed in the original size cannot be zoomed out.)

: The zoomed image will return to the original size.

: The displayed image will be zoomed in.

---

**Note:**

When "ON" is selected for "VMD alarm" (☞ page 27), the displayed images will not be zoomed in.

---

⑦ **Brightness buttons (\*2)**

: The displayed image will be darker.

: The adjusted brightness will return to the default brightness. (☞ page 24)

: The displayed image will be brighter.

⑧ **AUX buttons (\*2)**

: The AUX connector will open.

: The AUX connector will close.

⑨ **Camera name**

The set camera name will be displayed.

⑩  **Alarm occurrence indication button (\*2)**

This button will be displayed and will blink when an alarm occurred. When the button is clicked, the button will disappear and the alarm output connector will be reset. (☞ page 29)

⑪  **Full screen button**

Images will be displayed on a full screen. To return to the "Live" page, press the [Esc] key or the [F5] key, or the combination of the [Alt] key and the [F4] key on the keyboard.

⑫  **One shot button**

Click this button to take a picture (a still picture). The picture will be displayed on a newly opened window. When right-clicking on the displayed image, the pop-up menu will be displayed. The displayed image can be saved on the PC by selecting "Save" from the pop-up menu.

⑬  **Audio button**

The [Audio] button will be displayed only when "ON" is selected for "Mic mode" on the setup menu.

(☞ page 25)

When this button is clicked, the button will turn into the  button and audio will not be heard.

⑭ **Time and date**

Current time will be displayed in the set date/time display format (☞ page 17).

⑮ **Main area**

Images from the camera will be displayed in this area.

\*1 Operable by only users whose access level is "1. Administrator"

\*2 Only operable by users whose access level is "1. Administrator" or "2. Camera control" when "ON" is selected for "User authentication" (☞ page 34).

Refer to page 34 for further information about the access level.

# Monitor images from multiple cameras

Images from multiple cameras can be displayed on a multi-screen. Images from up to 4 cameras can be displayed simultaneously. To display images on a multi-screen, it is necessary to register cameras in advance. 4 cameras can be registered as a group and up to 2 groups (8 cameras) can be registered. (☞ page 26)

---

## Important:

- Select "OFF" for both the user authentication and the host authentication of the camera to be registered. (☞ pages 34 and 35)
  - Only JPEG images can be displayed on a multi-screen. Audio will not be heard.
  - When the power is turned off or the LAN cable is disconnected while displaying images, displaying images on a multi-screen from the "Live" page will become unavailable.
- 

## Step 1

Click the [Multi-screen] button.

→ Images from the registered cameras will be displayed on a 4-split screen.

- ① To display images on a single screen, click the [Live] button.
- ② Click a camera title. Live images from the camera corresponding to the clicked camera title will be displayed on the "Live" page of the newly opened window.

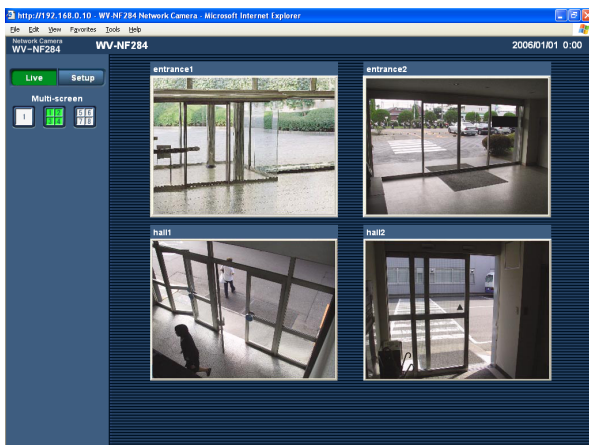

# Action at an Alarm Occurrence

The alarm action will be performed when the following alarm occur.

## Alarm type

- Terminal alarm:** When connecting an alarm device such as a sensor to the alarm connector on the mounting side of the camera, the alarm action will be performed when the connected alarm device activated.
- VMD alarm:** When a motion is detected in the set VMD area, the alarm action will be performed.
  - \* VMD stands for "Video Motion Detection".
- Command alarm:** When a Panasonic alarm protocol (☞ page 27) is received from the connected device via a network, the alarm action will be performed.

## Action at an Alarm Occurrence

### Display the [Alarm occurrence indication] button on the "Live" page (☞ page 5)

The [Alarm occurrence indication] button will be displayed on the "Live" page at an alarm occurrence.

---

#### Note:

The [Alarm occurrence indication] button will be refreshed in 30 seconds intervals. For this reason, it may take a maximum of 30 seconds until the [Alarm occurrence indication] button is displayed on the "Live" page at an alarm occurrence.

---

### Notify of alarm occurrences to the device connected to the alarm connector

It is possible to output signals from the alarm connector on the mounting side of the camera and sound the buzzer when an alarm occurs. The settings for the alarm output can be configured on the [Alarm] tab of the "Alarm setup" page. (☞ page 29)

### Transmit an image onto a server automatically

An alarm image can be transmitted at an alarm occurrence to the server designated in advance. The settings required to transmit an alarm image to a server can be configured in the "Alarm image setup" section of the [Alarm] tab of the "Alarm setup" page (☞ page 28) and the [FTP] tab of the "Server setup" page (☞ page 37).

### Notify of alarm occurrences by e-mail

Alarm mail (alarm occurrence notification) can be sent at an alarm occurrence to the e-mail addresses registered in advance. Up to 4 addresses can be registered as recipients of the alarm mail. An alarm image (still picture) can be sent with the alarm mail as an attached file. The settings for alarm mail can be configured in the "E-mail notification setup" section of the [Notification] tab of the "Alarm setup" page (☞ page 32) and the [Mail] tab of the "Server setup" page (☞ page 36).

### Notify of alarm occurrences to the designated IP addresses (Panasonic alarm protocol)

This function is available only when Panasonic device, such as the network disk recorder, is connected to the system. When "ON" is selected for "Panasonic alarm protocol", the connected Panasonic device will be notified that the camera is in the alarm state. The settings for Panasonic alarm protocol can be configured on the [Notification] tab of the "Alarm setup" page. (☞ page 33)



# Transmit Images onto an FTP Server

---

Images can be transmitted to an FTP server. By configuring the following settings, transmission of images captured at an alarm occurrence or captured at a designated interval to an FTP server will become available.

---

**Important:**

When using this function, set the user name and password to restrict users who can log into the FTP server.

---

## Transmit an alarm image at an alarm occurrence (Alarm image FTP transmission)

An alarm image can be transmitted at an alarm occurrence to the FTP server. To transmit alarm images to an FTP server, it is necessary to configure the settings in advance.

The settings for the FTP server can be configured on the [FTP] tab of the "Server setup" page. (☞ page 37)

The alarm image FTP transmission function can be turned on/off on the [Alarm] tab of the "Alarm setup" page. (☞ page 28)

---

**Note:**

Depending on the network traffic, number of the transmitted images may not reach the set number of images to be transmitted.

---

## Transmit images at a designated interval or period (FTP periodic transmission)

Images can be transmitted at a designated interval or period. To transmit images at a designate interval or period, it is necessary to configure the settings in advance.

The settings for the FTP server to which images are to be transmitted can be configured on the [FTP] tab of the "Server setup" page. (☞ page 37)

On the [FTP] tab of the "Network setup" page, the FTP periodic transmission function can be turned on/off, and the settings relating to schedules (periods) can be configured. (☞ page 43 - 45)

---

**Notes:**

- Depending on the network line speed or the network traffic, images may not be transmitted at the exact designated interval or period.
  - When "ON" is selected for both of the alarm image FTP transmission function and the FTP periodic transmission function, the alarm image FTP transmission function will be given priority over the FTP periodic transmission function. For this reason, images may not be transmitted at the exact designated interval or period if alarms occur frequently.
-

---

## Save images on the SD memory card when failed to transmit images by the FTP periodic transmission function

Images that have failed to transmit using the FTP periodic transmission can be saved automatically on the SD memory card. To obtain the images saved on the SD memory card, use the Windows command prompt or FTP client software. The obtained images can be browsed on a PC.

- \* When using the "SD memory REC" function of a Panasonic's network disk recorder, select "OFF" for the "FTP periodic transmission" function. (☞ page 43)
- \* When using the DHCP function, images will not be saved on the SD memory card until an IP address is assigned to the camera.
- \* We make no guarantee for any damages of files on the SD memory card incurred by malfunction or error occurrence in files saved on the SD memory card regardless of what the cause may be.

### Save images on the SD memory card

By configuring the following settings, saving images which had been failed to transmit to the FTP server using the FTP periodic transmission function will become available.

**About SD memory card:** Use (☞ page 19)

**File name:** With time and date (☞ page 43)

### Obtain images on the SD memory card

#### Step 1

Access the camera using the Windows command prompt or FTP client software.

→ The window with the user name and password entry fields will be displayed.

#### Step 2

Enter the user name whose access level is "1. Administrator" and its password.

→ Log in the camera.

---

#### Note:

The default user name with the access level "1. Administrator" and its password are as follows.

User name: admin

Password: 12345

To enhance the security, it is recommended to change the password for the administrator periodically.

---

### Step 3

Move the current directory to drive B and obtain images.

#### Notes:

- When logging in the camera, the current directory will be drive D. Images on the SD memory card can be found in the "FTP" directory under drive B. Move to the "FTP" directory and obtain images.

<Directory structure of drive B>

Example: To obtain the image (img\_06010101230000.jpg) using the Windows command prompt

- ① Enter "c:\>ftp 192.168.0.10" and press the [Enter] key.  
→ FTP connection will be established with "192.168.0.10".
- ② Log in by entering the user name and the password.
- ③ Enter "ftp>cd B:\FTP\060101\0123" and press the [Enter] key.  
→ The current directory will be "B:\FTP\060101\0123".

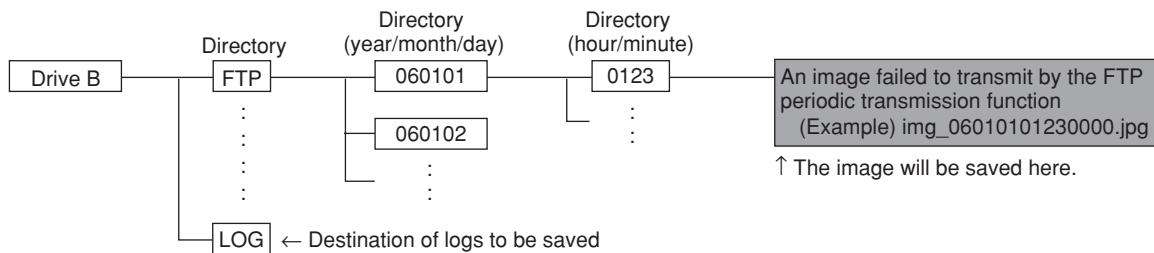

- ④ The transfer mode will be set to the binary mode. Enter "ftp>bin" and press the [Enter] key.
- ⑤ Enter "ftp> get img\_06010101230000.jpg" and press the [Enter] key.  
→ The image will be obtained.
- ⑥ Log out by entering "ftp>bye" and press the [Enter] key.

- It is possible to delete images on the SD memory card using the Windows command prompt, etc.

# About the network security of this unit

---

## Equipped security functions

The following security functions are featured in this camera.

① **Access restrictions by the host authentication and the user authentication**

It is possible to restrict users from accessing the camera by setting the host authentication and/or the user authentication to on. (☞ pages 34 and 35)

② **Access restrictions by changing the HTTP port**

It is possible to prevent illegal access such as port scanning, etc. by changing the HTTP port number. (☞ page 39)

---

**Note:**

When failed to pass the user authentication (authentication error) using the same IP address (PC) for 8 times within 5 minutes, access to the camera will be denied for a while.

---

---

**Important:**

Design and enhance security countermeasures to prevent leakage of information such as image data, authentication information (user name and password), alarm mail information, FTP server information, DDNS server information, etc.

---

# Display the Setup Menu and Configure the Settings of the Camera using a PC

The settings of the camera can be configured on the setup menu.  
The setup menu is only operable by users whose access level is "1. Administrator".

## How to display the setup menu

### Step 1

Display the "Live" page (see page 4).

### Step 2

Click the [Setup] button on the "Live" page.  
→ The window with the user name and password entry fields will be displayed.

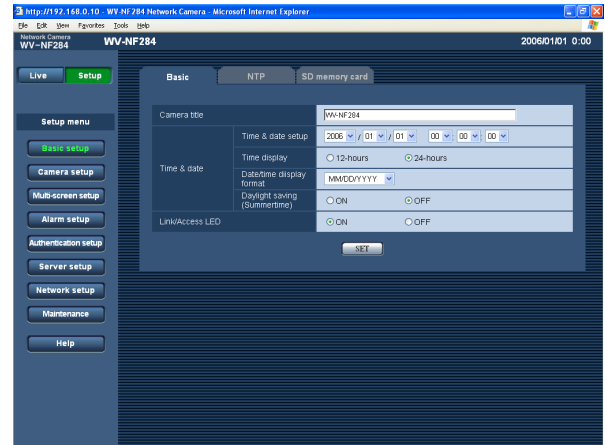
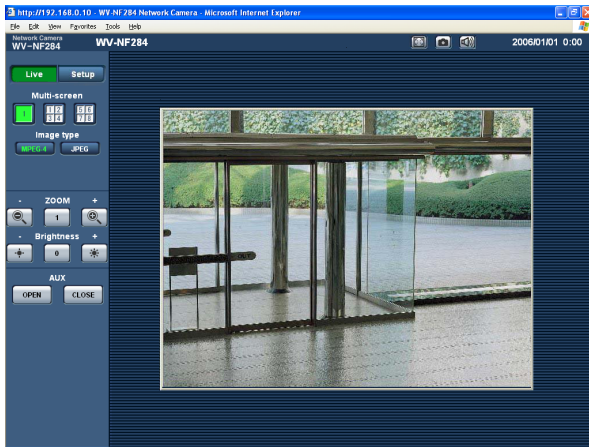

### Step 3

Click the [OK] button after entering the user name and the password.



→ Click this button to display the setup menu.  
Refer to the next page for further information about this menu.

# How to operate the setup menu

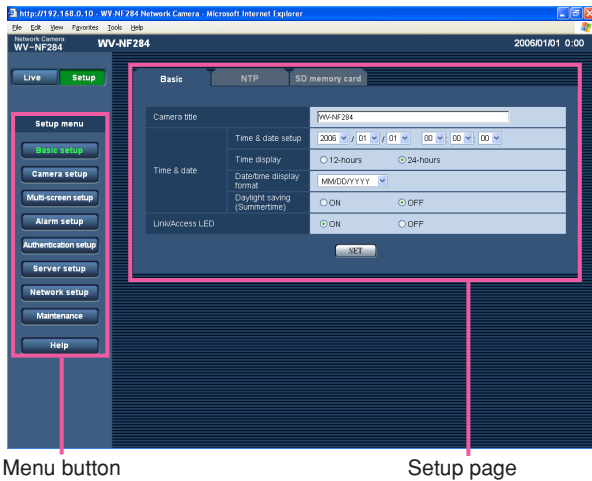

Menu button

Setup page

## Step 1

Click the desired button in the frame on the left of the window to display the respective setup menu.  
When there are tabs at the top of the setup page displayed in the frame on the right of the window, click the desired tab to display and configure the setting items relating to the name of the tab.

## Step 2

Complete each setting item displayed in the frame on the right of the window.

## Step 3

After completing each setting item, click the [SET] button (or [REG] button) to apply them.

## Important:

When there are two [SET] buttons (or [REG] buttons) or more on the page, click the respective button to the edited setting item.

<Example>

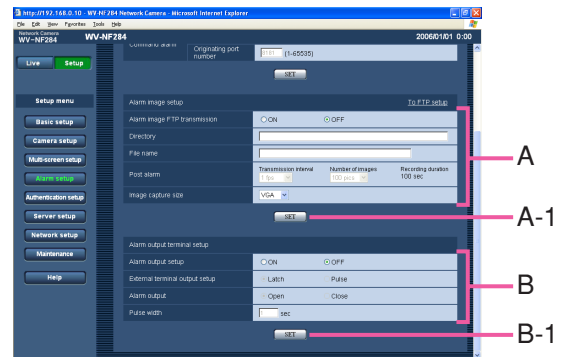

When completing the setting items in field A, click the [SET] button below field A (A-1). The edited setting items in field A will not be applied unless the [SET] button below field A (A-1) is clicked.  
In the same manner as above, click the [SET] button below field B (B-1) when completing the setting items in field B.

## About the operation window

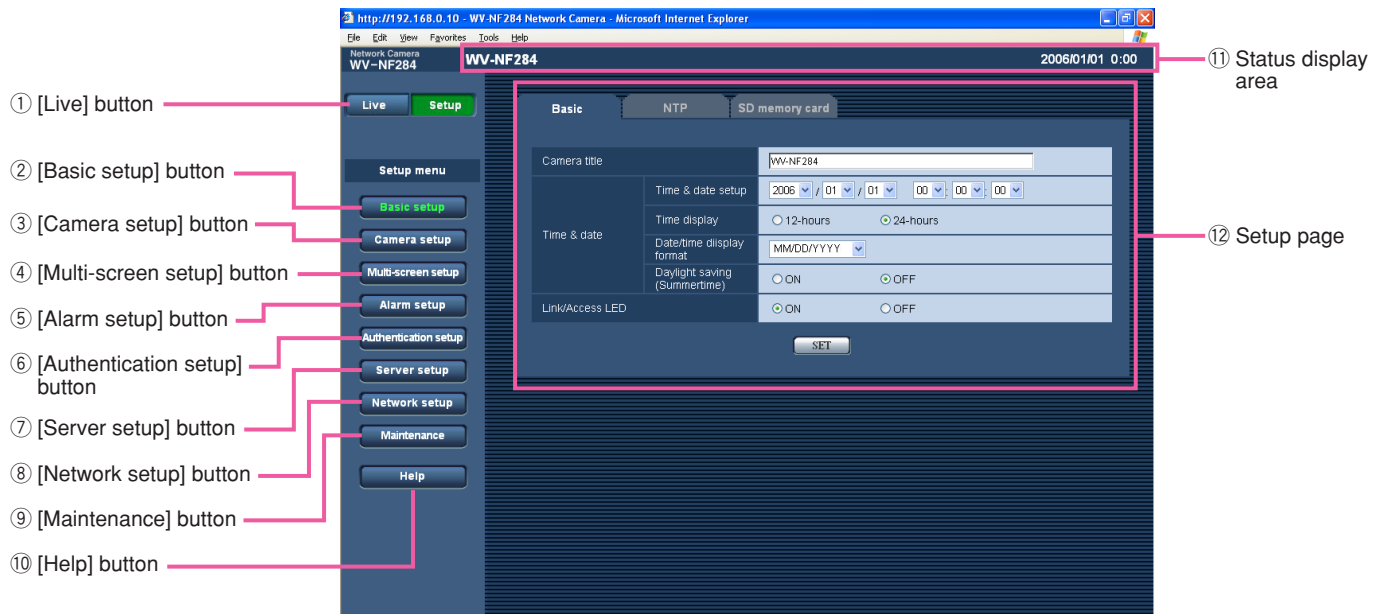

① **Live** [Live] button

The "Live" page will be displayed.

② **Basic setup** [Basic setup] button

Click this button to display the "Basic setup" page. The basic settings such as time and date and camera name, and the settings relating to the NTP server and the SD memory card can be configured on the "Basic setup" page. Refer to page 17 for further information.

③ **Camera setup** [Camera setup] button

Click this button to display the "Camera setup" page. The settings relating to image from the camera such as image quality and brightness, and the settings relating to audio can be configured on the "Camera setup" page. Refer to page 21 for further information.

④ **Multi-screen setup** [Multi-screen setup] button

Click this button to display the "Multi-screen setup" page. The cameras to be used for the multi-screen display can be registered on the "Multi-screen setup" page. Refer to page 26 for further information.

⑤ **Alarm setup** [Alarm setup] button

Click this button to display the "Alarm setup" page. The settings relating to alarm occurrences such as settings for the alarm action at an alarm occurrence, the alarm occurrence notification, and the VMD area settings can be configured on the "Alarm setup" page. Refer to page 27 for further information.

⑥ **Authentication setup** [Authentication setup] button

Click this button to display the "Authentication setup" page. The settings relating to the authentication such as users and PCs restrictions for accessing the camera can be configured on the "Authentication setup" page. Refer to page 34 for further information.

⑦ **Server setup** [Server setup] button

Click this button to display the "Server setup" page. The settings relating to the mail server and the FTP server to which the camera accesses can be configured on the "Server setup" page. Refer to page 36 for further information.

- 
- ⑧ **Network setup** **[Network setup] button**  
Click this button to display the "Network setup" page. The network settings and the settings relating to DDNS (Dynamic DNS), SNMP (Simple Network management Protocol) and FTP (File Transfer Protocol) can be configured on the "Network setup" page. Refer to page 38 for further information.
- ⑨ **Maintenance** **[Maintenance] button**  
Click this button to display the "Maintenance" page. System log check, firmware upgrade and initialization of the setup menu can be performed on the "Maintenance" page. Refer to page 46 for further information.
- ⑩ **Help** **[Help] button**  
Click this button to display the "Help" page.
- ⑪ **Status display area**  
The name of the camera whose settings currently being configured, and date and time will be displayed.
- ⑫ **Setup page**  
Pages of each setup menu will be displayed. There are tabs for some setup menus.



## Configure the basic settings of the camera [Basic setup]

The basic settings such as time and date and camera name, and the settings relating to the NTP server and the SD memory card can be configured on the "Basic setup" page.

The "Basic setup" page has 3 tabs of the [Basic] tab, the [NTP] tab and the [SD memory card] tab.

### Configure the basic settings [Basic]

Click the [Basic] tab on the "Basic setup" page. (page 15)

The settings such as the camera name, time and date, etc. can be configured on this page.

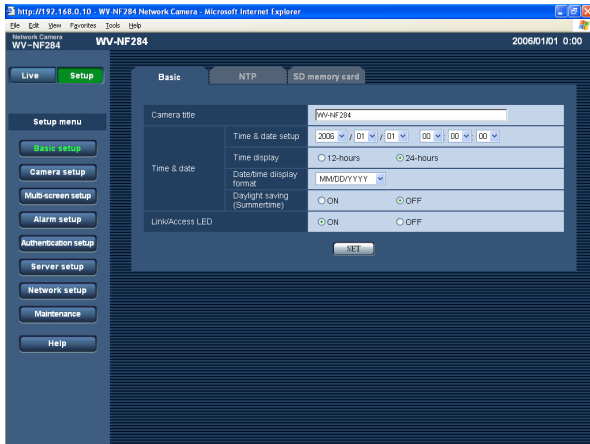

#### [Camera title]

Enter the title of the camera. Click the [SET] button after entering the title of the camera. The entered title will be displayed in the status display area.

**Number of characters for the camera title:** 0 - 20 characters

**Default setting:** WV-NF284

#### [Time and date setup]

Enter the current time and date. When "12-hours" is selected for "Time display", "AM" or "PM" can be selected.

**Available value:** 2006/01/01 00:00:00 -  
2035/12/31 23:59:59

#### Note:

"2036/01/01 00:00:00" or later is unavailable to set and display.

#### [Time display]

Select "12-hours" or "24-hours". Enter the current hour reflecting this setting when entering the current time and date for "Time and date setup".

**Default setting:** 24 hours

#### [Date/time display format]

Select a date/time display format.

When "04/01/2006 13:10:00" is set for "Time and date setup" after selecting "24-hours" for "Time display", time and date will be displayed as follows respectively.

**DD/MM/YYYY:** 01/04/2006 13:10

**MM/DD/YYYY:** 04/01/2006 13:10

**DD/Mmm/YYYY:** 01/Apr/2006 13:10

**YYYY/MM/DD:** 2006/04/01 13:10

**Mmm/DD/YYYY:** Apr/01/2006 13:10

**Default setting:** MM/DD/YYYY

#### [Daylight saving (Summertime)]

Select "ON" or "OFF" to determine whether or not to apply daylight saving time. Select "ON" or "OFF" to determine whether or not to apply daylight saving time.

**ON:** Applies summer time. An asterisk (\*) will be displayed on the left side of the displayed time and date.

**OFF:** Does not apply summer time.

**Default setting:** OFF

#### [Link/Access LED]

Select "ON" or "OFF" to determine whether or not to light the link indicator, the access indicator, and the SD memory card error indicator. Select "ON" to check the network status by lighting the indicators. Select "OFF" to turn off the indicators at all times.

- Even when "ON" is selected, the link indicator and the access indicator inside the dome cover will not light when the indicators ON/OFF switch on the camera is set to "OFF".

**Default setting:** ON

---

**Notes:**

- **Link indicator:** This indicator will light when communication with the connected device is available.
  - **Access indicator:** This indicator will light when accessing to a network.
  - **SD memory card error indicator:** This indicator will light when it is impossible to write data on the SD memory card.
- 

## Configure the settings relating to the NTP server [NTP]

Click the [NTP] tab on the "Basic setup" page. (☞ page 15)

The settings relating to the NTP server such as the NTP server address, port number, etc. can be configured on this page.

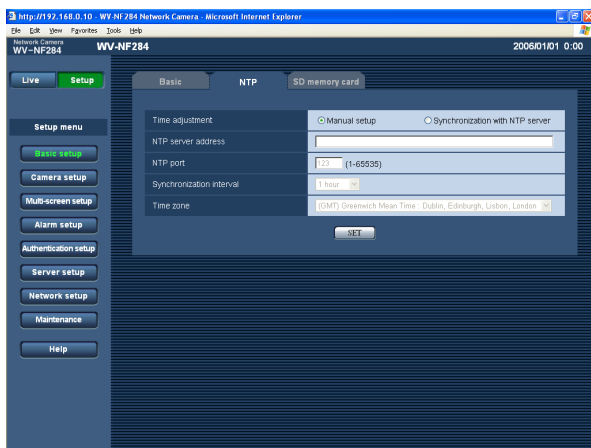

### [Time adjustment]

Select the time adjustment method from the following.

**Manual setup:** Time set on the [Basic] tab on the "Basic setup" page will be used as the standard time of the camera.

**Synchronization with NTP server:** Time automatically adjusted by synchronizing with NTP server will be used as the standard time of the camera.

**Default setting:** Manual setup

### [NTP server address]

Enter the IP address or the host name of the NTP server.

**Number of characters for the NTP server address:**

1 - 128 characters

**Default setting:** (blank)

---

**Important:**

When entering the host name for "NTP server address", it is necessary to configure the DNS settings on the [Network] tab of the "Network setup" page. (☞ page 39)

---

### [NTP port]

Enter a port number to be used for the NTP server.

**Available port number:** 1 - 65535

**Default setting:** 123

### [Synchronization interval]

Select an interval (1 - 24 hours: in 1 hour intervals) of synchronization with the NTP server.

**Default setting:** 1 hour

### [Time zone]

Select a time zone according to the location where the camera is in use.

**Default setting:** (GMT) Greenwich Mean Time: Dublin, Edinburgh, Lisbon, London

## Configure the settings relating to SD memory card [SD memory card]

Click the [SD memory card] tab on the "Basic setup" page. (☞ page 15)

The settings relating to the SD memory card can be configured on this page.

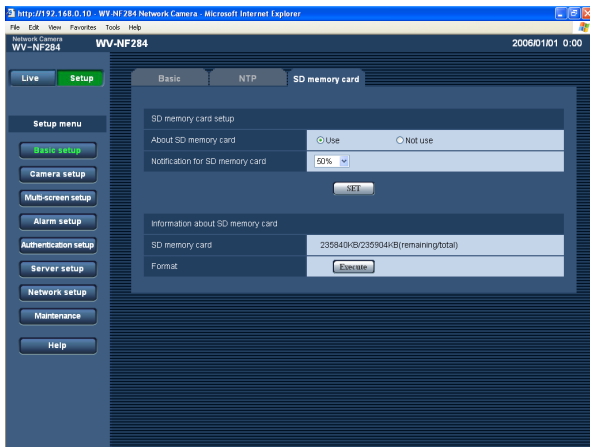

### ■ SD memory card setup

#### [About SD memory card]

Select "Use" or "Not use" to determine whether or not to use the SD memory card.

#### Important:

- Before removing the SD memory card from the camera, it is necessary to select "Not use" first.
- After inserting the SD memory card, it is necessary to select "Use" to use the SD memory card.

#### [Notification for SD memory card]

When the "E-mail notification" function or the "Panasonic alarm protocol" function is used to provide notification of the remaining space of the SD memory card, select a level to be notified at from the following.  
50 %/20 %/10 %/5 %/2 %

**Default setting:** 50 %

#### Note:

Notification will be provided each time the remaining space of the SD memory card reached the values above.

For example, notification will be provided each time the remaining space reaches 50%, 20%, 10%, 5% and 2% when "50%" is selected.

Notification may not always be made at the very moment when the remaining space of the SD memory card has reached each value.

### ■ Information about SD memory card

#### [SD memory card]

Available size and the total size of the SD memory card will be displayed.

Depending on the state of the SD memory card, the size indications will differ as follows.

| Indication      | Description   |
|-----------------|---|
| -----KB/-----KB | No SD memory card is inserted. Failed to obtain available size due to error, etc. |
| *****KB/*****KB | The SD card memory is locked, etc.  |

#### Note:

When the available size reached "0 KB", images will not be saved on the SD memory card. When the notification function is on, a notification mail will be sent to the registered addresses when the SD memory card becomes full. (☞ pages 32 and 33)

#### [Format]

To format the SD memory card, click the [Execute] button.

#### Important:

- Before formatting the SD memory card, it is necessary to select "Use" for "SD memory card" on the [SD memory card] tab of the "Basic setup" page (☞ page 19) and "OFF" for "FTP periodic transmission" on the [FTP] tab of the "Network setup" page (☞ page 43).
- Format the SD memory card only by clicking the [Execute] button on the setup menu. Otherwise, the following functions using the SD memory card may not work properly with this camera.
  - Save/obtain images when failed to transmit to the FTP server using the FTP periodic transmission function
  - Save/obtain the system logs
- It is impossible to access the SD memory card in the process of formatting.
- All data saved on the SD memory card will be deleted when the SD memory card is formatted.
- Do not turn the power of the camera off in the process of formatting.

- After formatting the SD memory card, available size may be smaller than the total size since the default directory is automatically created in the SD memory card.

- Compatible SD memory card is as follows.  
SD memory card\* manufactured by Panasonic (64 MB, 128 MB, 256 MB, 512 MB, 1 GB, 2GB)  
\* SD High Capacity (SDHC) card is not compatible with this unit.

### Possible number of images that can be saved on the SD memory card (as indications)

**Important:**

They are not actual numbers of images that can be saved on the SD memory card. Numbers will differ according to photographic subject, settings relating to the SD memory card, etc.

#### Image capture size: VGA

| Size of SD memory card | Image quality       |                     |                     |                     |                     |
|------------------------|---------------------|---------------------|---------------------|---------------------|---------------------|
|                        | 0 (Super fine)      | 1 (Fine)            | 2                   | 3                   | 4                   |
| 2 GB                   | Approx. 10 000 pics | Approx. 14 000 pics | Approx. 16 000 pics | Approx. 18 000 pics | Approx. 20 000 pics |
| 1 GB                   | Approx. 5 000 pics  | Approx. 7 000 pics  | Approx. 8 000 pics  | Approx. 9 000 pics  | Approx. 10 000 pics |
| 512 MB                 | Approx. 2 500 pics  | Approx. 3 500 pics  | Approx. 4 000 pics  | Approx. 4 500 pics  | Approx. 5 000 pics  |
| 256 MB                 | Approx. 1 250 pics  | Approx. 1 750 pics  | Approx. 2 000 pics  | Approx. 2 250 pics  | Approx. 2 500 pics  |
| 128 MB                 | Approx. 625 pics    | Approx. 875 pics    | Approx. 1 000 pics  | Approx. 1 125 pics  | Approx. 1 250 pics  |
| 64 MB                  | Approx. 312 pics    | Approx. 437 pics    | Approx. 500 pics    | Approx. 562 pics    | Approx. 625 pics    |
| Size of SD memory card | Image quality       |                     |                     |                     |                     |
|                        | 5 (Normal)          | 6                   | 7                   | 8                   | 9 (Low)             |
| 2 GB                   | Approx. 22 000 pics | Approx. 26 000 pics | Approx. 28 000 pics | Approx. 30 000 pics | Approx. 32 000 pics |
| 1 GB                   | Approx. 11 000 pics | Approx. 13 000 pics | Approx. 14 000 pics | Approx. 15 000 pics | Approx. 16 000 pics |
| 512 MB                 | Approx. 5 500 pics  | Approx. 6 500 pics  | Approx. 7 000 pics  | Approx. 7 500 pics  | Approx. 8 000 pics  |
| 256 MB                 | Approx. 2 750 pics  | Approx. 3 250 pics  | Approx. 3 500 pics  | Approx. 3 750 pics  | Approx. 4 000 pics  |
| 128 MB                 | Approx. 1 375 pics  | Approx. 1 625 pics  | Approx. 1 750 pics  | Approx. 1 875 pics  | Approx. 2 000 pics  |
| 64 MB                  | Approx. 687 pics    | Approx. 812 pics    | Approx. 875 pics    | Approx. 937 pics    | Approx. 1 000 pics  |

#### Image capture size: QVGA

| Size of SD memory card | Image quality       |                     |                     |                     |                     |
|------------------------|---------------------|---------------------|---------------------|---------------------|---------------------|
|                        | 0 (Super fine)      | 1 (Fine)            | 2                   | 3                   | 4                   |
| 2 GB                   | Approx. 24 000 pics | Approx. 26 000 pics | Approx. 27 000 pics | Approx. 28 000 pics | Approx. 30 000 pics |
| 1 GB                   | Approx. 12 000 pics | Approx. 13 000 pics | Approx. 13 500 pics | Approx. 14 000 pics | Approx. 15 000 pics |
| 512 MB                 | Approx. 6 000 pics  | Approx. 6 500 pics  | Approx. 6 750 pics  | Approx. 7 000 pics  | Approx. 7 500 pics  |
| 256 MB                 | Approx. 3 000 pics  | Approx. 3 250 pics  | Approx. 3 375 pics  | Approx. 3 500 pics  | Approx. 3 750 pics  |
| 128 MB                 | Approx. 1 500 pics  | Approx. 1 625 pics  | Approx. 1 687 pics  | Approx. 1 750 pics  | Approx. 1 875 pics  |
| 64 MB                  | Approx. 750 pics    | Approx. 812 pics    | Approx. 843 pics    | Approx. 875 pics    | Approx. 937 pics    |
| Size of SD memory card | Image quality       |                     |                     |                     |                     |
|                        | 5 (Normal)          | 6                   | 7                   | 8                   | 9 (Low)             |
| 2 GB                   | Approx. 32 000 pics | Approx. 36 000 pics | Approx. 38 000 pics | Approx. 40 000 pics | Approx. 42 000 pics |
| 1 GB                   | Approx. 16 000 pics | Approx. 18 000 pics | Approx. 19 000 pics | Approx. 20 000 pics | Approx. 21 000 pics |
| 512 MB                 | Approx. 8 000 pics  | Approx. 9 000 pics  | Approx. 9 500 pics  | Approx. 10 000 pics | Approx. 10 500 pics |
| 256 MB                 | Approx. 4 000 pics  | Approx. 4 500 pics  | Approx. 4 750 pics  | Approx. 5 000 pics  | Approx. 5 250 pics  |
| 128 MB                 | Approx. 2 000 pics  | Approx. 2 250 pics  | Approx. 2 375 pics  | Approx. 2 500 pics  | Approx. 2 625 pics  |
| 64 MB                  | Approx. 1 000 pics  | Approx. 1 125 pics  | Approx. 1 187 pics  | Approx. 1 250 pics  | Approx. 1 312 pics  |

## Configure the settings relating to images and audio [Camera setup]

The settings relating images and audio such as brightness and image quality of JPEG/MPEG-4 can configured on this page.

The "Camera setup" page has 3 tabs of the [JPEG/MPEG-4] tab, the [Camera] tab and the [Audio] tab.

## Configure the settings relating to JPEG/MPEG-4 images [JPEG/MPEG-4]

Click the [JPEG/MPEG-4] tab on the "Camera setup" page. (page 15)

### ■ JPEG setup

Configure the settings such as "Refresh interval (JPEG)", "Image capture size" and "Image quality" on this page. Refer to page 22 for further information about the settings relating to MPEG-4 images.

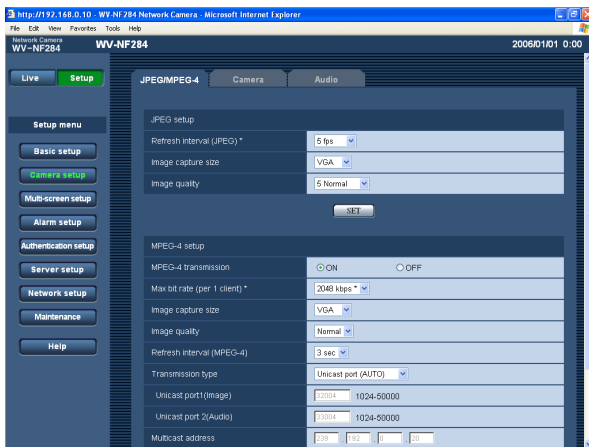

### [Image capture size]

Select "QVGA" or "VGA" for the image capture size of JPEG images.

**Default setting:** VGA

### [Image quality]

Select image quality of JPEG images from the following.  
0 Super fine/1 Fine/2/3/4/5 Normal/6/7/8/9 Low

**Default setting:** 5 Normal

### [Refresh interval (JPEG)\*]

Select an interval to refresh the displayed JPEG image from the following.

0.1 fps/0.2 fps/0.33 fps/0.5 fps/1 fps/2 fps/3 fps/5 fps/  
6 fps \*/10 fps \*/15 fps \*/30 fps \*

**Default setting:** 5 fps

### Note:

When "ON" is selected for "MPEG-4 transmission", the refresh intervals may be longer than the set value when the setting value with an asterisk (\*) on the right is selected.

## ■ MPEG-4 setup

Configure the settings relating to MPEG-4 image such as "Max bit rate (per 1 client)", "Image capture size", "Image quality", etc. in this section. Refer to page 21 for further information about the settings relating to JPEG images.

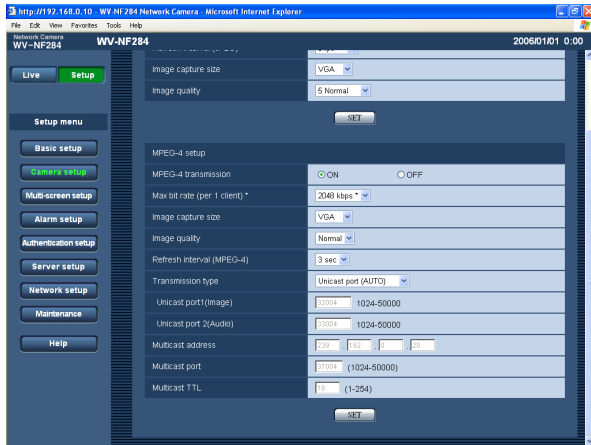

### [MPEG-4 transmission]

Select "ON" or "OFF" to determine whether or not to transmit MPEG-4 images.

**ON:** Transmits MPEG-4 images.

**OFF:** Does not transmit MPEG-4 images.

**Default setting:** ON

#### Note:

When "ON" is selected for "MPEG-4 transmission", displaying rather of MPEG-4 image or JPEG image will be available. However, the refresh interval (JPEG) may be longer than the set value when displaying JPEG images.

### [Max bit rate (per 1 client)\*]

Select a MPEG-4 bit rate per a client from the following.  
64 kbps/128 kbps \*/256 kbps \*/512 kbps \*/1024 kbps \*/  
1536 kbps \*/2048 kbps \*/3072 kbps \*/4096 kbps \*

**Default setting:** 2048 kbps \*

#### Note:

The MPEG-4 bit rate is synchronized with "Total bit rate" on the [Network] tab of "Network setup" page. (page 39) For this reason, the bit rate may be lower than the value when the setting value with an asterisk (\*) on the right is selected.

### [Image capture size]

Select "QVGA" or "VGA" for the image capture size of MPEG-4 images.

**Default setting:** VGA

### [Image quality]

Select image quality of MPEG-4 images from the following.

Fine/Normal/Low

**Default setting:** Normal

### [Refresh interval (MPEG-4)]

Select an interval (I-frame interval; 1 - 5 seconds) to refresh the displayed MPEG-4 images.

If using under the network environment with frequent error occurrences, shorten the refresh interval for MPEG-4 to diminish image distortions. However, the refresh interval (MPEG-4) may be longer than the set value when displaying JPEG images.

**Default setting:** 3 sec

### [Transmission type]

Select a MPEG-4 transmission type from the following.

**Unicast port (AUTO):** Up to 8 users can access a single camera concurrently. "Unicast port1 (Image)" and "Unicast port2 (Audio)" will automatically be selected when transmitting images and audio from the camera.

When it is unnecessary to fix the port number for MPEG-4 image transmission such as when using in a particular LAN environment, it is recommended to select "Unicast port (AUTO)".

**Unicast port (MANUAL):** Up to 8 users can access a single camera concurrently. It is necessary to select "Unicast port1 (Image)" and "Unicast port2 (Audio)" manually to transmit images and audio from the camera.

It is possible to fix the port number of the router used for MPEG-4 image transmission via the Internet by setting "Unicast port (MANUAL)". Refer to the operating instructions of the router in use.

**Multicast:** No concurrent access limitation for a camera.

\* Refer to page 4 for further information about the maximum concurrent access number.

**Default setting:** Unicast port (AUTO)

---

**[Unicast port1 (Image)]**

Enter the unicast port number (used to transmit image from the camera).

**Available value:** 1024 - 50000 (Only even numbers are available.)

**Default setting:** 32004

**[Unicast port2 (Audio)]**

Enter the unicast port number (used to transmit audio from the camera).

**Available value:** 1024 - 50000 (Only even numbers are available.)

**Default setting:** 33004

**[Multicast address]**

Enter the multicast IP address.

Images and audio will be transmitted to the designated IP address.

**Available value:** 224.0.0.0 - 239.255.255.255

**Default setting:** 239.192.0.20

**[Multicast port]**

Enter the multicast port number (used to transmit MPEG-4 images from the camera).

**Available value:** 1024 - 50000 (Only even numbers are available.)

**Default setting:** 37004

**[Multicast TTL]**

Enter the multicast TTL value.

**Available value:** 1 - 254

**Default setting:** 16

---

**Important:**

- Depending on the PC in use for monitoring, the multicast port number may be already in use. In this case, it may be impossible to monitor images. Change the multicast port number.
  - When transmitting MPEG-4 image via a network, the transmitted image sometimes may not be displayed. In this case, refer to the network administrator.
  - When two or more network interface cards are installed on the PC in use, the network interface card(s) not used for receiving images should be invalidated when displaying images using the multicast port.
-

## Configure the camera settings such as image quality and brightness, etc. [Camera]

Click the [Camera] tab on the "Camera setup" page. (☞ page 15)

The following are descriptions of how to configure the settings relating to images such as brightness, etc.

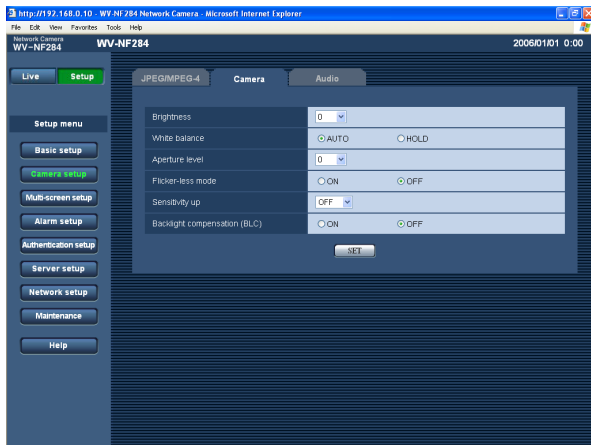

### [Brightness]

17 steps (–8 - 8) are available for brightness. The value "–8" is the darkest and "8" is the brightest.

**Default setting:** 0

### [White balance]

Select the white balance adjustment method from the following.

**AUTO:** Adjusts the white balance automatically.

**HOLD:** Fixes to the white balance applied when the [SET] button is clicked.

**Default setting:** AUTO

### [Aperture level]

9 steps (–4 - 4) are available for aperture level (sharpness). The value "–4" is the softest and "4" is the sharpest.

**Default setting:** 0

### [Flicker-less mode]

Select "ON" or "OFF" to determine whether or not to use the flicker-less mode. Normally, select "OFF". When using the camera under fluorescent lamps and flickers appear, select "ON".

**Default setting:** ON

---

### Note:

When using the camera under low-light intensity, the flicker-less function may not work effectively even when "ON" is selected. In this case, select an interval for "Refresh interval (JPEG)" (☞ page 21) from the following; 0.1 fps/0.2 fps/0.5 fps/1 fps/2 fps/5 fps/10 fps

---

### [Sensitivity up]

Select the sensitivity from the following.

**OFF:** Does not use the sensitivity adjustment.

**x2:** Adjusts the sensitivity up to x2 automatically.

**x4:** Adjusts the sensitivity up to x4 automatically.

**x8:** Adjusts the sensitivity up to x8 automatically.

**x16:** Adjusts the sensitivity up to x16 automatically.

**Default setting:** OFF

---

### Important:

When the sensitivity is incremented, the refresh interval may be longer.

---

### [Backlight compensation (BLC)]

Select "ON" or "OFF" to determine whether or not to compensate backlight.

**ON:** Compensates backlight. (Suitable when the subject has backlight.)

**OFF:** Does not compensate backlight. (Suitable when the subject has light in the front.)

**Default setting:** OFF



## Configure the settings relating to audio [Audio]

Click the [Audio] tab on the "Camera setup" page. (page 15)  
The settings relating to audio can be configured on this page.

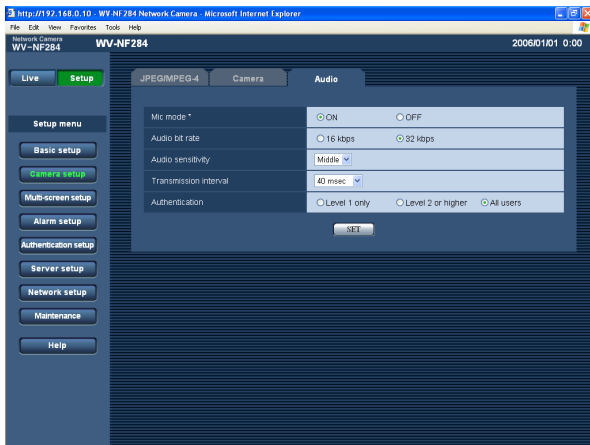

### [Mic mode\*]

Select "ON" or "OFF" to determine whether to turn on or off audio on a PC.

**ON:** Transmits audio from the camera to the PC. Audio can be heard with images on the PC. Images and audio will not be synchronized.

**OFF:** Audio will not be transmitted from the camera to the PC. Therefore, no settings and controls relating audio will be invalidated.

**Default setting:** ON

### [Audio bit rate]

Select "16 kbps" or "32 kbps" for audio bit rate.

**Default setting:** 32 kbps

### [Audio sensitivity]

Select the sensitivity of the built-in microphone of the camera from the following.

Low/Middle/High

**Default setting:** Middle

### [Transmission interval]

Select an interval for audio transmission from the following.

20 msec/40 msec/80 msec/160 msec

**Default setting:** 40 msec

---

### Note:

When a shorter interval is selected, delay time will be shorter. When a longer interval is selected, audio interruption may be diminished even though delay time will be longer.

Select the interval according to the network environment.

---

### [Authentication]

Select an access level for audio transmission from the following. Refer to page 34 for further information about the access level.

Level 1 only/Level 2 or higher/All users

**Default setting:** All users

---

### Note:

Images and audio will not be synchronized.

Therefore, images and audio may not always match.

---

## Configure the multi-screen settings [Multi-screen setup]

The cameras to be used for the multi-screen display can be registered on this page. Refer to page 15 for descriptions of how to display images on a multi-screen.

\* The following cameras are available for the multi-screen display.

WV-NF284, WV-NS202, WV-NP240 series, WV-NP1000 series, WV-NW470S series, WV-NP472, WV-NS320 series

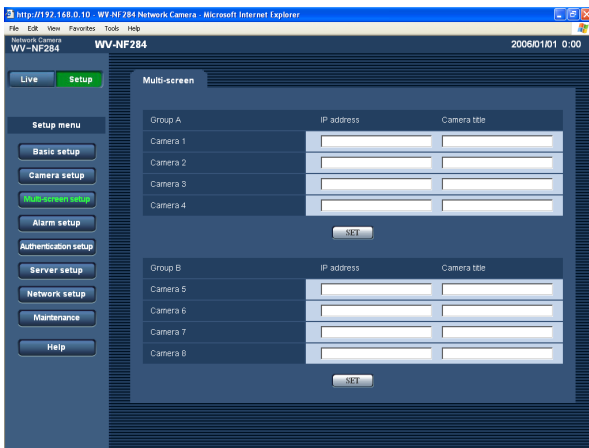

### [IP address]

Enter the IP address or the host name of the camera to be used for the multi-screen. 4 cameras can be registered as a group and up to 2 groups (8 cameras) can be registered.

**When the HTTP port number for the camera had been changed, enter as follows:** (Example:

192.168.0.10:8080)

**Number of characters for the IP address:** 1 - 128 characters

---

### Note:

When using the host name, it is necessary to configure the DNS settings of the PC in use. (☞ page 39)

---

### [Camera title]

The entered camera title will be displayed on a multi-screen.

**Number of characters for the camera title:** 0 - 20 characters

## Configure the alarm settings [Alarm setup]

The settings relating to alarm occurrences such as settings for the alarm action at an alarm occurrence, the alarm occurrence notification, and the VMD area settings can be configured on this page.

The "Alarm setup" page has 3 tabs of the [Alarm] tab, the [VMD area] tab and the [Notification] tab.

### Configure the settings relating to the alarm action [Alarm]

Click the [Alarm] tab on the "Alarm setup" page. (☞ page 15)

#### ■ Alarm setup

The settings relating to the alarm action can be configured on this page. Refer to pages 28 and 29 for further information about the settings relating to the alarm image and the alarm out connector.

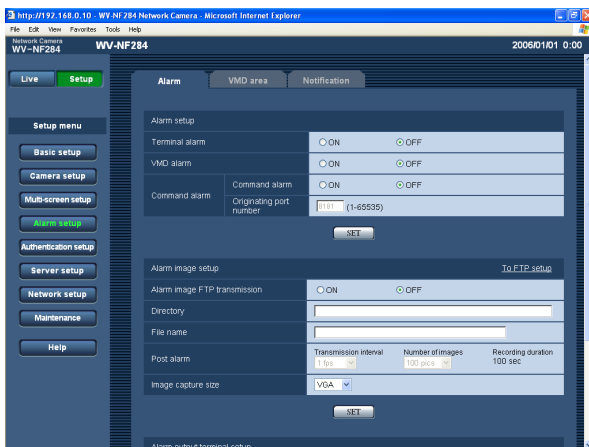

#### [Originating port number]

Select a port number to be used to receive the command alarm.

**Available value:** 1 - 65535

**Default setting:** 8181

#### [Terminal alarm]

Select "ON" or "OFF" to determine whether or not to receive the terminal alarm.

**Default setting:** OFF

#### [VMD alarm]

Select "ON" or "OFF" to determine whether or not to perform the alarm action using the VMD function. Refer to page 30 for descriptions of how to set the VMD areas.

**Default setting:** OFF

#### [Command alarm]

Select "ON" or "OFF" to determine whether or not to receive the command alarm.

The command alarm is the function that notifies of Panasonic alarm protocol from the other cameras. When "ON" is selected, alarm actions will be performed between multiple cameras.

**Default setting:** OFF

## Configure the settings relating to the alarm image

Click the [Alarm] tab on the "Alarm setup" page. (☞ page 15)

### ■ Alarm image setup

The settings relating to the alarm image to be transmitted to the FTP server can be configured on this page. The alarm image will be transmitted to the FTP server. To transmit alarm images to the FTP server, it is necessary to configure the settings in advance. (☞ page 37)

Refer to pages 27 and 29 for further information about the settings relating to the alarm action at an alarm occurrence and the alarm out connector.

#### Important:

Depending on the network line speed or the network traffic, images may not be transmitted at the exact designated interval or period.

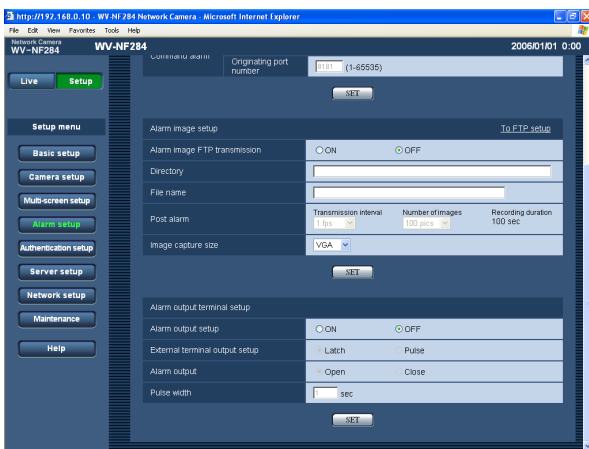

#### [To FTP setup]

When "To FTP setup" is clicked, the [FTP] tab of the "Server setup" page will be displayed. (☞ page 37)

#### [Alarm image FTP transmission]

Select "ON" or "OFF" to determine whether or not to transmit the alarm image to the FTP server.

**Default setting:** OFF

#### [Directory]

Enter the directory name where the alarm images are to be saved.

For example, enter "/ALARM" to designate the directory "ALARM" under the FTP root directory.

**Number of characters for the directory name:** 0 - 256 characters

#### [File name]

Enter the file name used for the alarm image to be transmitted to the FTP server. The file name will be as follows.

["Entered file name" + "Time and date (year/month/day/hour/minute/second)"] + "Serial number"

**Number of characters for the file name:** 1 - 8 characters

#### [Post alarm]

##### • Transmission interval

Select a transmission interval for the alarm image FTP transmission from the following.

0.1 fps/0.2 fps/0.33 fps/0.5 fps/1 fps

**Default setting:** 1 fps

##### • Number of images

Select the number of images to be transmitted from the following.

10 pics/20 pics/ 30 pics/50 pics/100 pics/  
200 pics/300 pics/500 pics/1000 pics/2000 pics/  
3000 pics/5000 pics

**Default setting:** 100 pics

##### • Recording duration

Approximate time to be taken to save the set "number of images" with the set "transmission interval" will be displayed.

#### [Image capture size]

Select "QVGA" or "VGA" for the image capture size of images to be transmitted to the FTP server or of an image to be attached to the alarm mail.

**Default setting:** VGA

## Configure the settings relating to the alarm out connector

Click the [Alarm] tab on the "Alarm setup" page. (☞ page 15)

### ■ Alarm output terminal setup

The settings relating to the alarm out connector can be configured on this page. Refer to pages 27 and 28 for further information about the settings relating to the alarm action at an alarm occurrence and the alarm image.

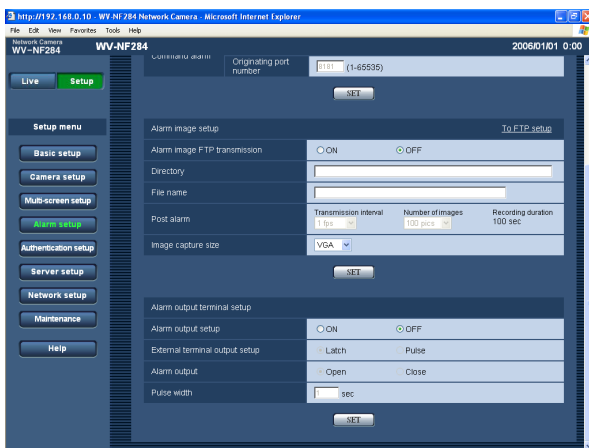

#### [Alarm output setup]

Select "ON" or "OFF" to determine whether or not to output the alarm signals to the alarm out connector when an alarm is detected.

**Default setting:** OFF

#### [External terminal output setup]

Select "Latch" or "Pulse" for the alarm out connector at an alarm occurrence.

**Latch:** When an alarm is detected, alarm output connector will be in the state selected for "Alarm output" until the [Alarm reset] button is clicked.

**Pulse:** When an alarm is detected, alarm output connector will be in the opposite state to the "Alarm output" setting for the period set for "Pulse width".

**Default setting:** Latch

#### [Alarm output]

Select "Open" or "Close" to determine whether to open or close the alarm output connector when output the alarm signals.

**Open:** The alarm out connector will open when output the alarm signals. (Normally close)

**Close:** The alarm out connector will close when output the alarm signals. (Normally open)

**Default setting:** Open

---

#### Note:

When "Open" is selected, the alarm signal will be output for around 20 seconds when the power of the camera is turned on.

---

#### [Pulse width]

When "Pulse" is selected for "Alarm output", select an pulse width.

**Available value:** 1 - 120 sec

**Default setting:** 1 sec

## Set the VMD areas [VMD area]

Click the [VMD area] tab on the "Alarm setup" page. (page 15)

The video motion detection areas can be set on this page.

When a motion is detected in the set area, the alarm action will be performed.

## Set the VMD areas

### Step 1

Set the video motion detection area by dragging the mouse on the screen. When the [All areas] button is clicked, the whole area will become the VMD area, and "1 (White)" will be automatically applied to "Area".

→ The designated area will become the VMD area and the outline will be displayed. When 2 - 4 VMD areas are set, each area will be numbered in order.

The areas will be identified by the respective outline colours.

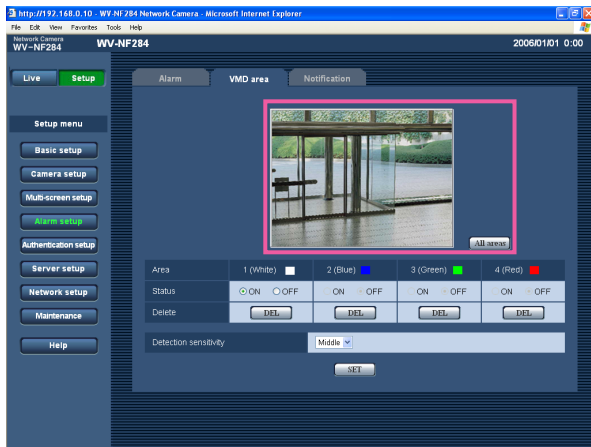

### Step 2

Select "ON" or "OFF" for "Status" of each VMD area. When the [SET] button is clicked after selecting "OFF", the outline will become the broken line and no alarm action will be performed even when a motion is detected in the area.

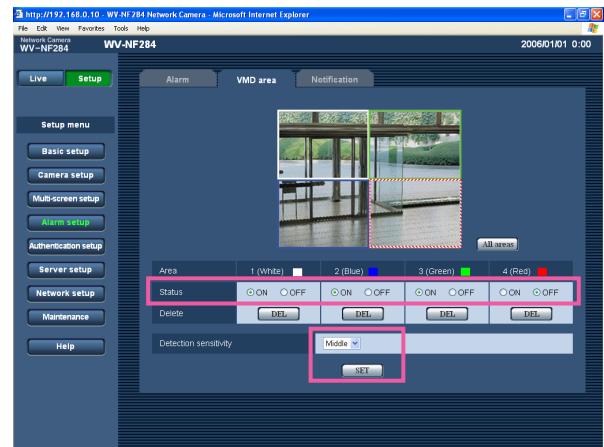

### Step 3

Select the detection sensitivity from the following. The selected detection sensitivity will be applied to all the VMD areas.

High/Middle/Low

**Default setting:** Middle

### Step 4

Click the [SET] button after completing the settings.

### Important:

The setting will not be applied unless the [SET] button is clicked.

## Delete the set VMD area

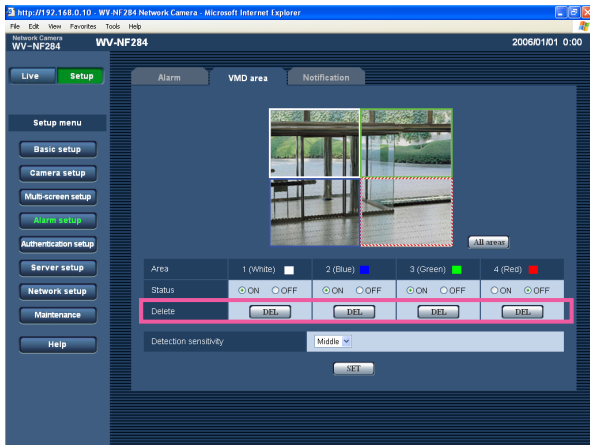

### Step 1

Click the [Delete] button respective to the area to be deleted.

→ The outline of the area will disappear.

### Step 2

Click the [SET] button.

→ The deletion will be completed.

---

### Important:

The deletion will not be completed unless the [SET] button is clicked.

---

## Configure the settings relating to the mail notification [Notification]

Click the [Notification] tab on the "Alarm setup" page. (☞ page 15)

### ■ E-mail notification setup

The settings relating to the alarm mail can be configured on this page. To notify of an alarm occurrence by e-mail, it is necessary to configure the settings of the mail server. (☞ page 36)

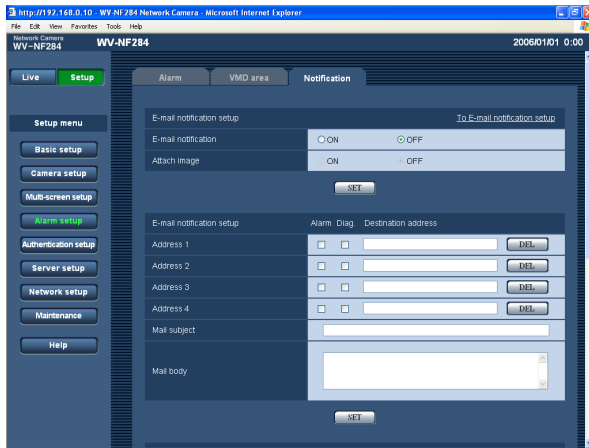

#### [E-mail notification]

Select "ON" or "OFF" to determine whether or not to notify of an alarm occurrence by e-mail at an alarm occurrence.

**Default setting:** OFF

#### [Attach image]

Select "ON" or "OFF" to determine whether or not to attach an image to the mail to be sent.

**Default setting:** OFF

---

#### Note:

The settings for "Image capture size" of the "Alarm image setup" section on the [Alarm] tab (☞ page 28) will be applied to the size of the image to be attached.

---

### ■ E-mail notification setup

#### [Destination address]

Enter the destination mail address. Up to 4 destination addresses can be registered.

To notify by e-mail when an alarm occurred, check the "Alarm" checkbox respective to the desired address.

To provide notification by e-mail when any of the following has occurred, check the "Diag." checkbox respective to the desired address.

When notification of the remaining space of the SD memory card has been provided (☞ page 19)

When the SD memory card has become full/When mounting of the SD memory card failed

To delete the registered address, click the [DEL] button respective to the desired address.

**Number of characters for the destination mail address:** 3 - 128 characters

#### [Mail subject]

Enter the mail subject.

**Number of characters for the mail subject:** 0 - 50 characters

#### [Mail body]

Enter the mail body.

**Number of characters for the mail body:** 0 - 200 characters

---

#### Note:

Notification mail will be sent with the following message. (The message to be sent differs depending on the status of the SD memory card.)

- "The SD memory card is full." (This message will be sent when the SD memory card becomes full.)
  - "The SD memory card cannot be recognized." (This message will be sent when the SD memory card has failed to mount.)
-



## Configure the settings relating to Panasonic alarm protocol

Click the [Notification] tab on the "Alarm setup" page. (☞ page 15)

### ■ Panasonic alarm protocol setup

The settings relating to Panasonic alarm protocol can be configured on this page.

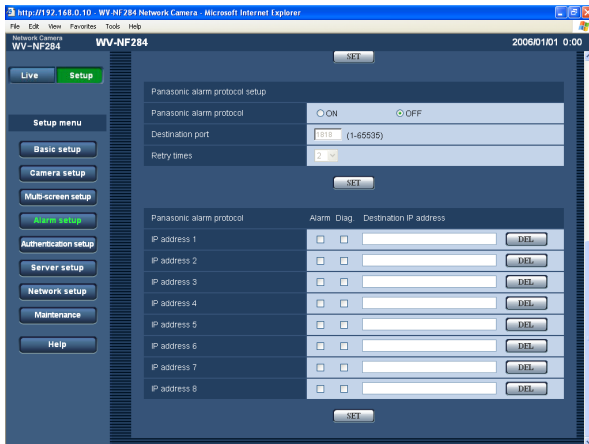

#### [Panasonic alarm protocol]

Select "ON" or "OFF" to determine whether or not to notify of an alarm occurrence by Panasonic alarm protocol when an alarm is detected.

**Default setting:** OFF

#### Note:

When "ON" is selected, the alarm occurrence will be notified to the registered destination IP addresses in order (to IP address 1 first, to IP address 8 last).

#### [Destination port]

Select a destination port of the Panasonic alarm protocol from the following.

**Available value:** 1 - 65535

**Default setting:** 1818

#### [Retry times]

Select a retry time of Panasonic alarm protocol.

**Available value:** 1 - 30

**Default setting:** 2

### ■ Panasonic alarm protocol

#### [Destination IP address]

Enter the destination IP address of the Panasonic alarm protocol from the following. Host name is unavailable for the IP address. Up to 8 destination addresses can be registered.

To notify by Panasonic alarm protocol when an alarm occurred, check the "Alarm" checkbox respective to the desired address.

To provide notification using Panasonic alarm protocol when any of the following has occurred, check the "Diag." checkbox respective to the desired address.

- When notification of the remaining space of the SD memory card has been provided (☞ page 19)
- When the SD memory card has become full
- When mounting of the SD memory card has failed

To delete the registered address, click the [DEL] button respective to the desired address.

#### Important:

Confirm that the destination IP addresses are registered correctly. When a registered IP address does not exist, notification may be delayed.

## Configure the settings relating to the authentication [Authentication setup]

The settings relating to the authentication such as users and PCs restrictions for accessing the camera can be configured on this page.

The "Authentication setup" page has 2 tabs of the [User] tab and the [Host] tab.

### Configure the settings relating to the user authentication [User]

Click the [User] tab on the "Authentication setup" page. (page 15)

The settings relating to the user authentication can be configured on this page. Up to 16 users can be registered.

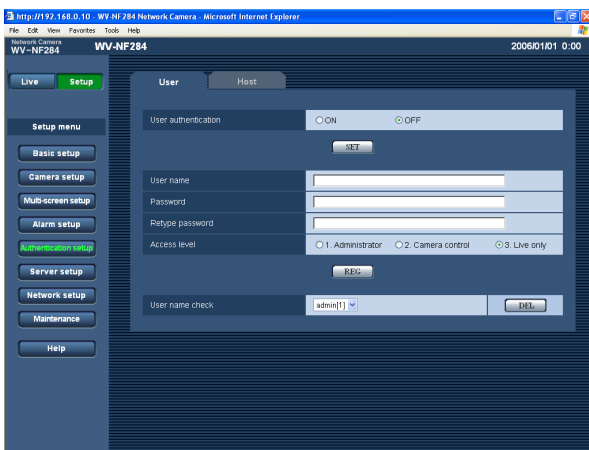

#### [User authentication]

Select "ON" or "OFF" to determine whether or not to authenticate the user.

**Default setting:** OFF

#### [User name]

Enter a user name.

**Number of characters for the user name:** 1 - 32 characters

**Default setting:** (blank)

#### [Password] [Retype password]

Enter the password.

**Number of characters for the password:** 4 - 32 characters

**Default setting:** (blank)

---

#### Note:

When the user name already in use is entered and the [REG] button is clicked, the respective user information will be overwritten.

---

#### [Access level]

Select the access level of the host from the following.

- 1. Administrator:** Allowed all available operations of the camera.
- 2. Camera control:** Allowed to display images from the camera and to control the camera. The camera setting configuration is unavailable.
- 3. Live only:** Only displaying live images is available. The camera setting configuration and camera control are unavailable.

**Default setting:** 3. Live only

---

#### Note:

By clicking [√] of "User name check", the registered user can be selected and the selected user's information can be checked.

The registered user will be displayed with the access level. (Example: admin [1])

To delete the registered user, click the [DEL] button after selecting the user to be deleted.

---

---

#### Important:

If all users whose access level is "1. Administrator" is deleted, it will be impossible to configure the settings.

---

## Configure the settings relating to the host authentication [Host]

Click the [Host] tab on the "Authentication setup" page. (page 15)

The settings to restrict PCs (IP address) to access the camera can be configured on this page.

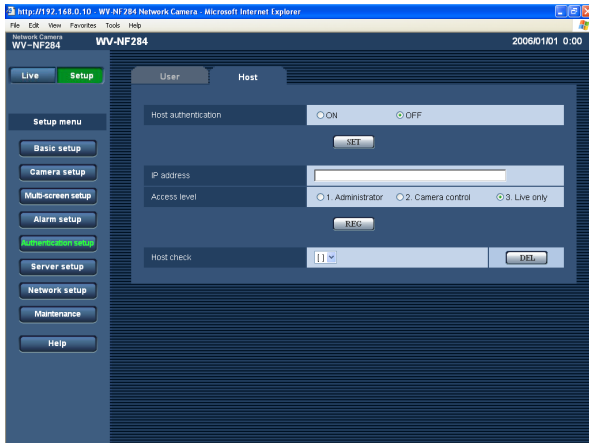

### [Host authentication]

Select "ON" or "OFF" to determine whether or not to authenticate the host.

**Default setting:** OFF

### Important:

Before configuring the host authentication, it is necessary to register IP addresses of the PCs to be allowed to access the camera and determine their access levels. If "ON" is selected for "Host authentication" before registering the hosts (IP addresses), it will be impossible to access the camera.

### [IP address]

Enter the IP address of the PC to be allowed to access the camera.

Host name is unavailable for the IP address.

### Notes:

- When "IP address/subnet mask" is entered, it is possible to restrict PCs in each subnet.  
For example, when "192.168.0.1/24" is entered and "2. Camera control" is selected for the access level, the PCs whose IP address is between "192.168.0.0" - "192.168.0.255" can access the camera with the access level "2. Camera control".
- When the IP address already in use is entered and the [REG] button is clicked, the respective host information will be overwritten.

### [Access level]

Select the access level of the host from the following.

1. Administrator/2. Camera control/3. Live only

Refer to page 34 for further information about the access level.

**Default setting:** 3. Live only

### Note:

By clicking [✓] of "Host check", the registered host can be selected and the selected host's IP address can be checked.

The registered IP address will be displayed with the access level. (Example: 192.168.0.21 [1])

To delete the registered host, click the [DEL] button after selecting the IP address to be deleted.

## Configure the settings of the servers [Server setup]

The settings relating to the mail server and the FTP server can be configured on this page.  
The "Server setup" page has 2 tabs of the [Mail] tab and the [FTP] tab.

### Configure the settings relating to the mail server [Mail]

Click the [Mail] tab on the "Server setup" page. (page 15)

The settings relating to the mail server used to send the alarm mail can be configured on this page.

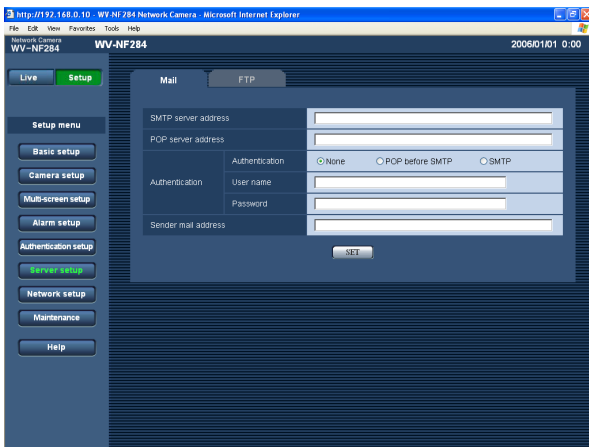

#### [SMTP server address]\*

Enter the IP address or the host name of the SMTP server used to send e-mails.

**Number of characters for the SMTP server address:**

1 - 128 characters

#### [POP server address]\*

When "POP before SMTP" is selected for "Authentication", enter the IP address or the host name of the POP server.

**Number of characters for the POP server address:**

1 - 128 characters

---

#### Important:

When entering the host name for "SMTP server address", it is necessary to configure the DNS settings on the [Network] tab of the "Network setup" page. (page 39)

---

#### [Authentication]

Select the authentication method to send e-mails from the following.

**None:** It is not necessary to clear any authentication to send e-mails.

**POP before SMTP:** It is necessary to clear the POP server authentication first to use the SMTP server to send e-mails.

**SMTP:** It is necessary to clear the SMTP server authentication to send e-mails.

**Default setting:** None

---

#### Note:

When you don't know the authentication method to send e-mails, refer to the network administrator.

---

#### [User name]

Enter the user name to access the server.

**Number of characters for the user name:** 1 - 32 characters

#### [Password]

Enter the password to access the server.

**Number of characters for the password:** 0 - 32 characters

#### [Sender mail address]

Enter the mail address of a sender.

Entered mail address will be displayed in the "From" (sender) line of the sent mails.

**Number of characters for the sender's mail address:**  
3 - 128 characters

## Configure the settings relating to the FTP server [FTP]

Click the [FTP] tab on the "Server setup" page. (☞ page 15)

The settings relating to the FTP server used to transmit the alarm images can be configured on this page.

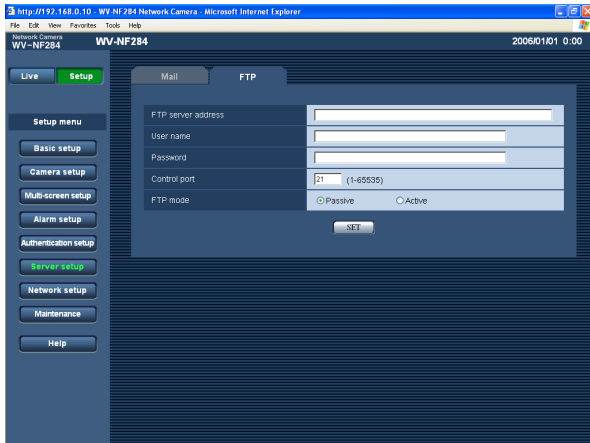

### [Control port]

Enter a control port number to be used for the FTP server.

**Available port number:** 1 - 65535

**Default setting:** 21

### [FTP mode]

Select "Passive" or "Active" for the FTP mode.

Normally, select "Passive". When failed to establish the connection, select "Active".

**Default setting:** Passive

### [FTP server address]

Enter the IP address or the host name of the FTP server.

**Number of characters for the FTP server address:**

1 - 128 characters

---

#### Note:

When entering "localhost" for "FTP server address", alarm images will be sent to the SD memory card. In this case, images will not be sent to the FTP server periodically.

---

#### Important:

When entering the host name for "FTP server address", it is necessary to configure the DNS settings on the [Network] tab of the "Network setup" page. (☞ page 39)

---

### [User name]

Enter the user name (login name) to access the FTP server.

**Number of characters for the user name:** 1 - 32 characters

### [Password]

Enter the password to access the FTP server.

**Number of characters for the password:** 0 - 32 characters

# Configuring the network settings [Network setup]

The network settings and the settings relating to DDNS (Dynamic DNS) and SNMP (Simple Network management Protocol) can be configured on this page.

The "Network setup" page has 4 tabs of the [Network] tab, the [DDNS] tab, the [SNMP] tab and the [FTP] tab.

## Configure the network settings [Network]

Click the [Network] tab on the "Network setup" page. (page 15)

The following information is required to configure the network settings.

Contact the network administrator or your Internet service provider.

- IP address
- Net mask
- Default gateway (when using the gateway server/router)
- HTTP port Number
- Primary DNS, Secondary DNS (when using DNS)

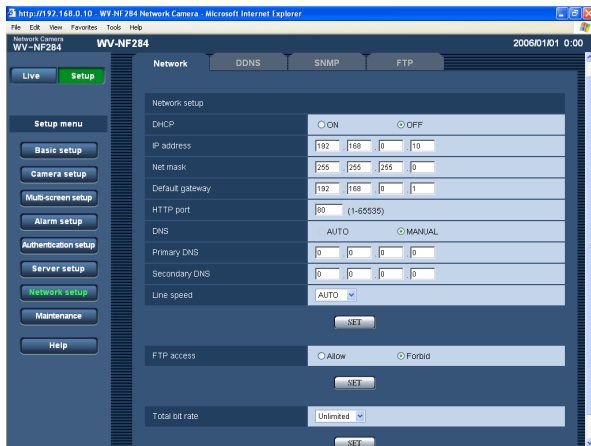

### ■ Network setup

#### [DHCP]

Select "ON" or "OFF" to determine whether or not to use the DHCP function.

Configure the DHCP server not to assign the same IP addresses used for the other network cameras and PCs whose IP address is unique. Refer to the network administrator for the settings of the server.

**Default setting:** OFF

#### [IP address]

When not using the DHCP function, enter the IP address of the camera. Do not enter the IP address already in use (for the PCs and the other network cameras).

**Default setting:** 192.168.0.10

---

#### <Unavailable IP addresses>

- 0.\*.\*
  - \*.\*.\*.0
  - 255.\*.\*
  - \*.\*.\*.255
  - 127.0.0.1
  - Class D address (224.0.0.0 - 239.255.255.255)
  - Class E address (240.0.0.0 - 255.255.255.255)
- \* These IP addresses are unavailable even when using the DHCP function. Refer to the network administrator for the settings of the DHCP server.
- 

#### [Net mask]

When not using the DHCP function, enter the net mask of the camera.

**Default setting:** 255.255.255.0

### [Default gateway]

When not using the DHCP function, enter the default gateway of the camera.

**Default setting:** 192.168.0.1

---

#### <Unavailable IP addresses for the default gateway>

- 0.\*.\*
  - \*.\*.\*0
  - 255.\*.\*
  - \*.\*.\*255
  - 127.0.0.1
  - Class D address (224.0.0.0 - 239.255.255.255)
  - Class E address (240.0.0.0 - 255.255.255.255)
- \* These IP addresses for the default gateway are unavailable even when using the DHCP function. Refer to the network administrator for the settings of the DHCP server.
- 

### [HTTP port]

Assign the port numbers independently.

The following port numbers are unavailable since they are already in use.

**Available port number:** 1 - 65535

**Default setting:** 80

---

#### <Port numbers already in use>

20, 21, 23, 25, 42, 53, 67, 68, 69, 110, 123, 161, 162, 995, 10669, 10670

---

### [DNS]

Select "AUTO" or "MANUAL" to determine whether or not to use the DNS. When "MANUAL" is selected, it is necessary to configure the settings for the DNS.

When using the DHCP function, it is possible to obtain the DNS address automatically by selecting "AUTO".

Refer to the network administrator for further information about the settings.

**Default setting:** MANUAL

### [Primary DNS], [Secondary DNS]

When "MANUAL" is selected for "DNS", enter the IP address of the DNS. Refer to the network administrator about the IP address of the DNS.

### [Line speed]

Select the line speed for data transmission from the followings. It is recommended to use the default setting "AUTO".

**AUTO:** Line speed will be applied automatically.

**100MF:** 100 Mbps full-duplex

**100MH:** 100 Mbps half-duplex

**10MF:** 10 Mbps full-duplex

**10MH:** 10 Mbps half-duplex

**Default setting:** AUTO

### [FTP access]

Select "Allow" or "Forbid" to determine whether to allow or forbid the FTP access.

**Default setting:** Forbid

### [Total bit rate]

Select the total bit rate for data transmission from the followings.

64 kbps/128 kbps/256 kbps/512 kbps/1024 kbps/

2048 kbps/4096 kbps/Unlimited

**Default setting:** Unlimited

---

#### Notes:

- When selecting "64 kbps", select "OFF" for "Mic mode" on the "Audio" tab. (page 25)
  - When "64 kbps" is selected, it is impossible to carry out the live-transmission of JPEG images and the FTP periodic transmission simultaneously.
-

**Notes:**

- The port forwarding function changes a global IP address to a private IP address, and "Static IP masquerade" and "Network Address Translation (NAT)" have this function. This function is to be set in a router.
- To access the camera via the Internet by connecting the camera to a broadband router, it is necessary to assign a respective port number for each camera and address translation by using the port forwarding function. For further information, refer to the operating instructions of the broadband router in use.

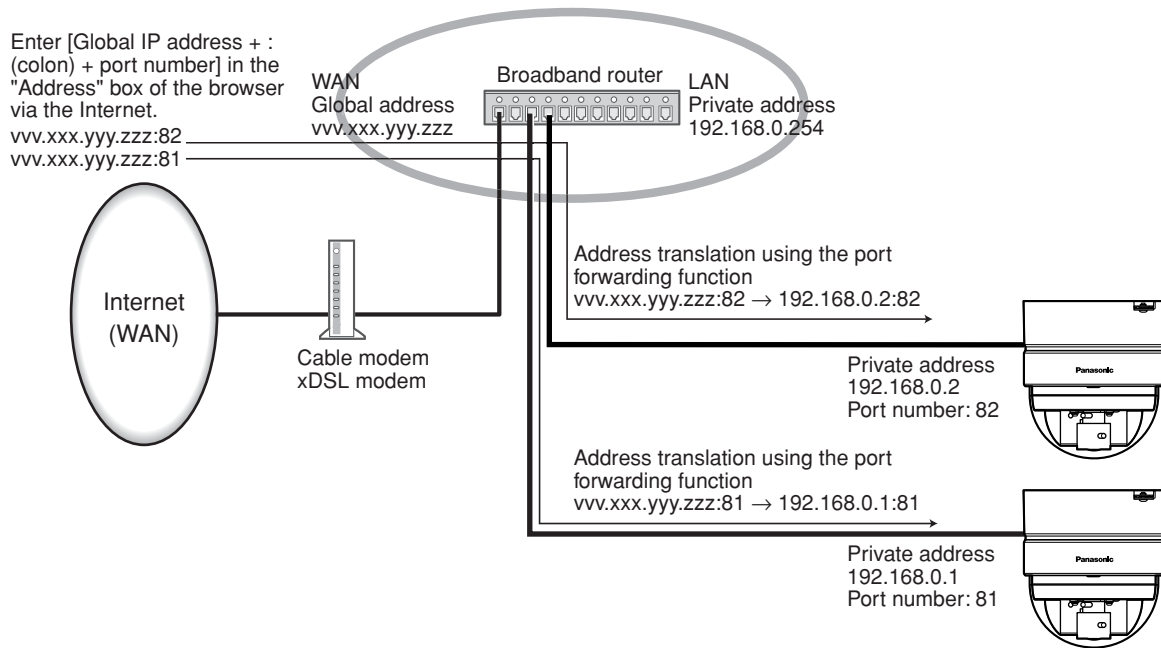



## Configure the settings relating to DDNS [DDNS]

Click the [DDNS] tab on the "Network setup" page. (page 15)

The settings relating to DDNS can be configured on this page.

When accessing the camera via the Internet from the network environment of which the global IP address is obtained using DHCP, the DDNS function is necessary.

When using the DDNS function, it is possible to access with "Host name registered in the DDNS server. nmdns.net". To use the DDNS function, it is necessary to connect to the dedicated DDNS server. Refer to the web site for further information about the DDNS. Refer to the "Readme" file about the web site.

It is necessary to configure the host name, user name and password registered in the DDNS server.

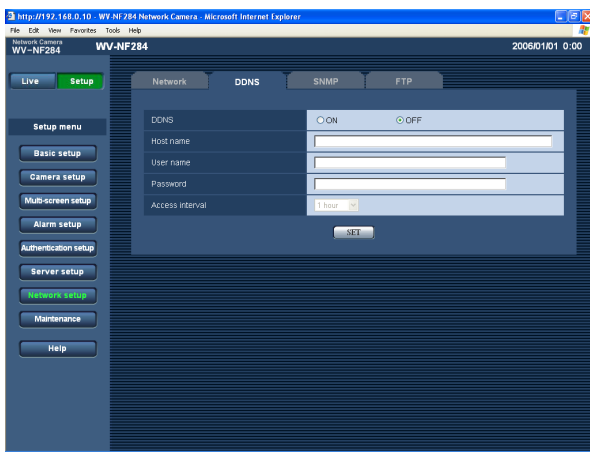

### [Access interval]

Select the interval to access the DDNS server to check the IP address and the host name from the following.

1 min/10 min/30 min/1 hour/6 hours/24 hours

**Default setting:** 1 hour

### [DDNS]

Select "ON" or "OFF" to determine whether or not to use the DDNS function.

**Default setting:** OFF

### [Host name]

Enter the host name to be used.

**Number of characters for the host name:** 1 - 64 characters

### [User name]

Enter the user name (login name) to access the DDNS server.

**Number of characters for the user name:** 1 - 32 characters

### [Password]

Enter the password to access the DDNS server.

**Number of characters for the password:** 0 - 32 characters

## Configure the settings relating to SNMP [SNMP]

Click the [SNMP] tab on the "Network setup" page. (page 15)

The settings relating to SNMP can be configured on this page. It is possible to check the status of the camera by connecting to the SNMP manager. When using the SNMP function, contact the network administrator.

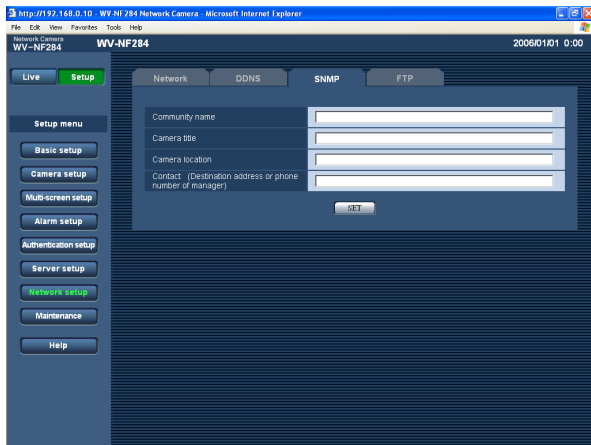

### [Contact (Destination address or phone number of manager)]

Enter the mail address or the phone number of the SNMP manager.

**Number of characters for the destination address or the phone number of manager:** 0 - 255 characters

**Default setting:** (blank)

### [Community name]

Enter the community name to be monitored.

**Number of characters for the community name:**

0 - 32 characters

**Default setting:** (blank)

---

### Important:

When using the SNMP function, it is necessary to enter the community name. When no community name is entered, the SNMP function will not work.

---

### [Camera title]

Enter a camera title to be used to manage the camera with the SNMP function.

**Number of characters for the camera title:** 0 - 32 characters

**Default setting:** (blank)

### [Camera location]

Enter the name of the location where the camera is installed.

**Number of characters for the camera location:** 0 - 32 characters

**Default setting:** (blank)

## Configure the settings relating to the FTP periodic transmission [FTP]

Click the [FTP] tab on the "Network setup" page. (☞ page 15)

### ■ FTP periodic transmission

The settings relating to the periodic transmission of images to an FTP server can be configured on this page. To transmit images to an FTP server periodically, it is necessary to configure the settings of the FTP server in advance. (☞ page 37) Refer to page 44 for descriptions of how to configure schedules of image transmission.

#### Important:

- Depending on the network line speed or the network traffic, images may not be transmitted at the exact designated interval or period.
- When "ON" is selected for both of the alarm image FTP transmission function and the FTP periodic transmission function, the alarm image FTP transmission function will be given priority over the FTP periodic transmission function. For this reason, images may not be transmitted at the exact designated interval or period if alarms occur frequently.

#### Note:

Images failed to transmit by the FTP periodic transmission can be saved automatically on the SD memory card. (☞ page 10)

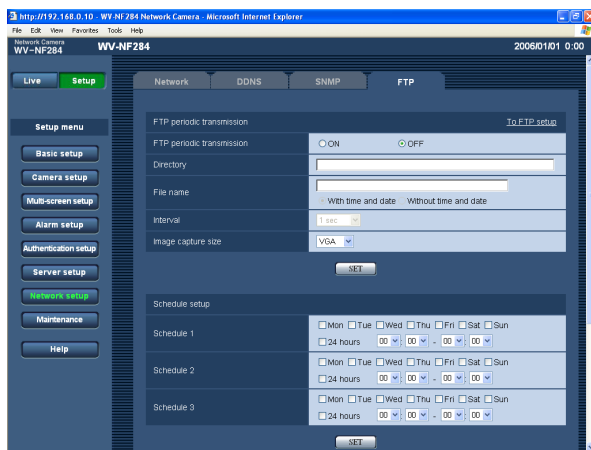

#### [FTP periodic transmission]

Select "ON" or "OFF" to determine whether or not to transmit images using the FTP periodic transmission function. When "ON" is selected, it is necessary to configure the settings of the FTP server. (☞ page 37)

**Default setting:** OFF

#### [Directory]

Enter the directory name where the images are to be saved.

For example, enter "/img" to designate the directory "img" under the FTP root directory.

**Number of characters for the directory name:** 0 - 256 characters

**Default setting:** (blank)

#### [File name]

Enter the file name (name of the image file to be transmitted) and select the naming option from the following.

**With time and date:** File name will be ["Entered file name" + "Time and date (year/month/day/hour/minute/second)" + "00"].

**Without time and date:** File name will be the characters entered for "File name" only. When "Without time and date" is selected, the file will be overwritten each time a file is transmitted newly.

**Number of characters for the file name:** 1 - 32 characters

**Default setting:** (blank)

#### [Interval]

Select the interval for the FTP periodic transmission from the following.

1 sec/2 sec/3 sec/4 sec/5 sec/6 sec/10 sec/15 sec/20 sec/30 sec/1 min/2 min/3 min/4 min/5 min/6 min/10 min/15 min/20 min/30 min/1 hour/1.5 hours/2 hours/3 hours/4 hours/6 hours/12 hours/24 hours

**Default setting:** 1 sec

#### [Image capture size]

Select "QVGA" or "VGA" for the image capture size of the images to be transmitted by the FTP periodic transmission.

**Default setting:** VGA

## Configure the schedule settings of the FTP periodic transmission

Click the [FTP] tab on the "Network setup" page. (☞ page 15)

### ■ Schedule setup

The schedule settings of the FTP periodic transmission can be configured on this page. Refer to page 43 for further information about the settings relating to the FTP periodic transmission.

### How to configure the schedule settings

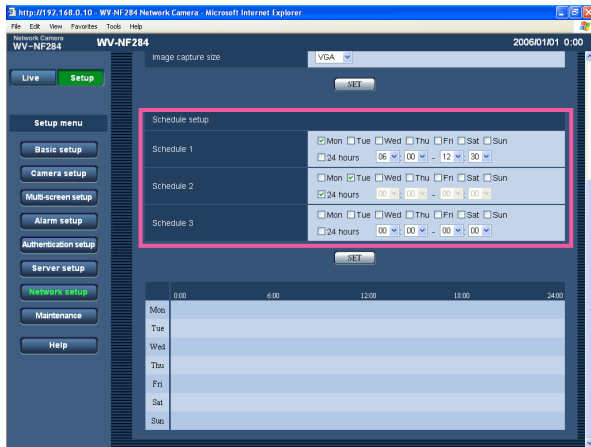

#### Step 1

Check the check box of the desired day of the week.  
→ The selected day of the week will be validated for the schedule.

#### Step 2

To designate time, click [√] and select the desired "hour" and "minute".  
When not designating time, check the checkbox of "24 hours".

#### Step 3

Click the [SET] button after completing the settings.  
→ The result will be displayed at the bottom of the window.

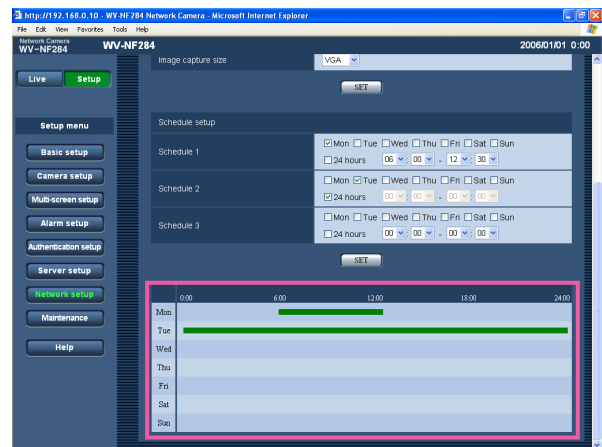

## How to delete the set schedule

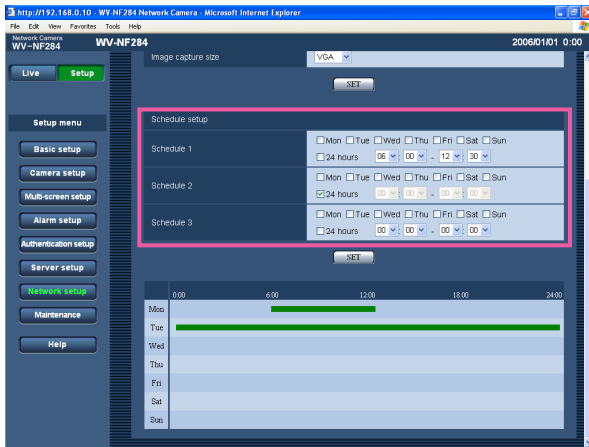

### Step 1

Uncheck the check box of the set day of the week.

### Step 2

Click the [SET] button after completing the settings.  
→ The result will be displayed at the bottom of the window.

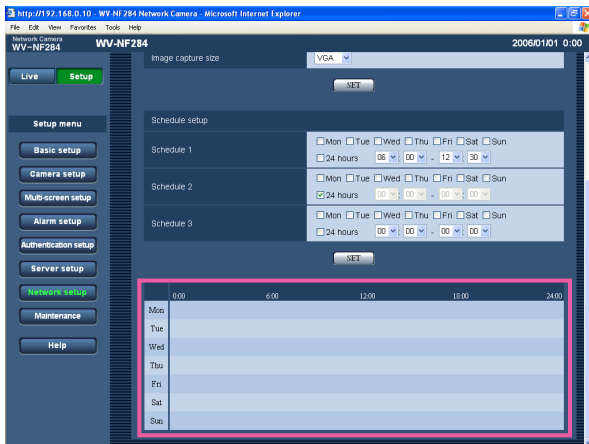

## Maintenance of the camera [Maintenance]

System log check, firmware upgrade, and initialization of the setup menu can be performed on this page. The "Maintenance" page has 3 tabs of the [System log] tab, the [Upgrade] tab and the [Initialization] tab.

### Check the system log [System log]

Click the [System log] tab of the "Maintenance" page. (☞ page 15)

Up to 4 000 system logs can be saved on the SD memory card when the SD memory card is inserted after selecting "Use" for "About the SD memory card" on the [SD memory card] tab (☞ page 19)

When "Not use" is selected for "About the SD memory card", up to 100 system logs can be saved on the built-in memory of the camera.

When the saved system logs have reached the maximum number, the newer logs will overwrite the older system logs. In this case, the oldest log is the first to be overwritten.

The system logs will be displayed in 100 logs each.

When using the SD memory card, the logs will be saved even when the power of the camera is turned off. When not using the SD memory card, the logs will be deleted when the power of the camera is turned off.

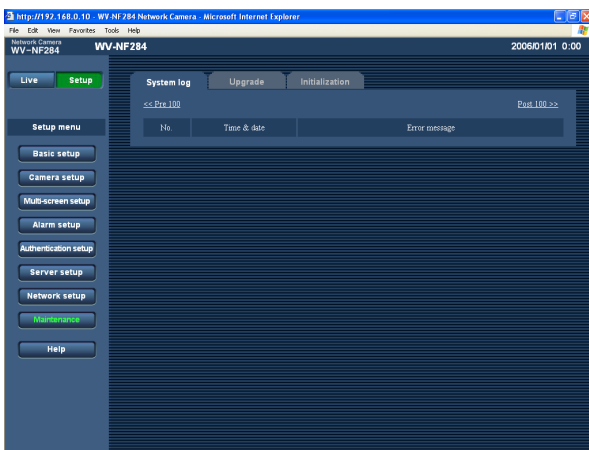

#### [Time & date]

Time and date at the error occurrence will be displayed.

#### [Error message]

The descriptions about the error will be displayed.

Refer to page 49 for further information about the system logs.

## Upgrade the firmware [Upgrade]

Click the [Upgrade] tab of the "Maintenance" page. (page 15)

The current firmware can be checked and upgraded to the latest version on this page. Contact the dealer for further information about the firmware upgrade.

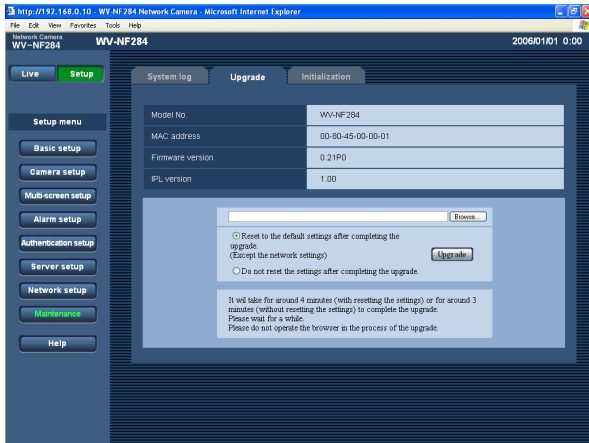

[Model No.], [MAC address], [Firmware version], [IPL version]

Information of each item will be displayed.

## How to upgrade the firmware

### Step 1

Contact the dealer and download the latest firmware onto a PC.

### Important:

A blank (space) cannot be used for the name of the directory where the downloaded firmware to be saved.

### Step 2

Click the [Browse...] button and designate the downloaded firmware.

### Step 3

Click the radio button respective to the desired option to determine whether or not to initialize the settings after the firmware upgrade.

### Note:

Read the "readme" file provided with the firmware first and determine whether or not to initialize the settings after the firmware upgrade.

### Step 4

Click the [Upgrade] button.

→ The confirmation window will be displayed. When "Do not reset the settings after completing the upgrade." was selected, the confirmation window will not be displayed.

### Important:

- Upgrade the firmware using a PC in the same sub-net as of the camera's.
- Follow the instruction's of the dealer when upgrading the firmware.
- Use the designated file (extension:img) for the firmware upgrade.
- The name of the firmware to be used for upgrade should be "nf284\_xxxxx.img".
  - \* ("xxxxx" indicates the version of the firmware.)
- Do not turn the power of the camera off in the process of upgrade.
- Do not operate the web browser (including adjusting the window size) in the process of upgrade.
- The following network settings will not be initialized when upgrade the firmware after selecting "Reset to the default setting after completing the upgrade. (Except the network settings)".  
ON/OFF for DHCP, IP address, net mask, default gateway, HTTP port, line speed, total bit rate, time & date

## Initialize/restart the camera [Initialization]

Click the [Initialization] tab of the "Maintenance" page. (☞ page 15)

Initialization of the setup data and HTML files of the camera and restarting of the camera can be performed on this page.

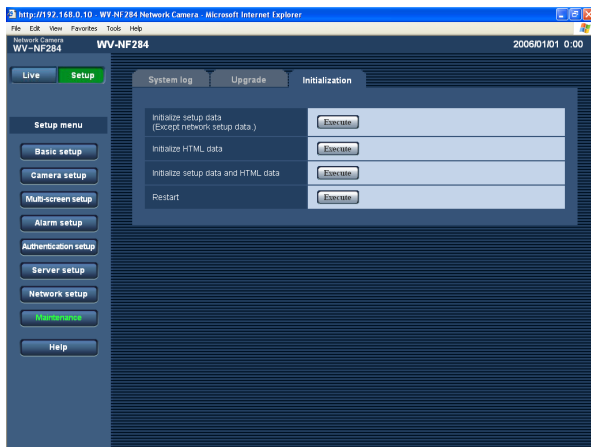

### [Initialize setup data]

Click the [Execute] button to reset the settings to the default. However, the network settings will not be reset. It is impossible to operate the camera for around 1 minute after the initialization.

### [Initialize HTML data]

Click the [Execute] button to reset the HTML files to the default. It is impossible to operate the camera for around 1 minute after the initialization.

### [Initialize setup data and HTML data]

Click the [Execute] button to reset the settings of the camera and the HTML files to the default. However, the network settings will not be reset. It is impossible to operate the camera for around 1 minute after the initialization.

### [Restart]

Click the [Execute] button to restart the camera. The camera will be inoperable for around 1 minute after the restart just as when the power is turned on.

---

#### Notes:

- To initialize the network settings, turn off the power of the camera first. Then, turn on the power of the camera while holding down the [INITIAL SET] button of the camera. Wait around 5 seconds without releasing the [INITIAL SET] button. Wait around 30 seconds after releasing the button. The camera will restart and the settings including the network settings will be initialized.
  - When the notification function is on, notification will be provided to the registered addresses (mail address or IP address) when the SD memory card has failed to mount after the restart or when the inserted SD memory card is locked. (☞ pages 32 and 33)
-



# About the Displayed System Log

## Error indications relating to SMTP

| Category          | Content  | Description  |
|-------------------|--|--|
| POP3 server error | Authentication error                           | Entered user name or password may be incorrect. Check if the mail settings are configured correctly.   |
|                   | Cannot connect to POP3/SMTP server.            | <ul style="list-style-type: none"><li>• The IP address of the server may be incorrect. Check if the IP address of the server is configured correctly.</li><li>• The POP3 server may be down. Ask the network administrator.</li></ul>    |
| SMTP server error | SMTP authentication error                      | Entered user name or password may be incorrect. Check if the mail settings are configured correctly.   |
|                   | Failed to resolve mail server address from DNS | <ul style="list-style-type: none"><li>• The designated IP address of the DNS server may be incorrect. Check if the DNS settings are configured correctly.</li><li>• The DNS server may be down. Ask the network administrator.</li></ul> |
|                   | Cannot connect to SMTP server.                 | <ul style="list-style-type: none"><li>• The IP address of the server may be incorrect. Check if the IP address of the server is configured correctly.</li><li>• The SMTP server may be down. Ask the network administrator.</li></ul>    |
| Internal error    | Other error                                    | An error occurred in the mail function. Check if the mail settings are configured correctly.   |

## Error indications relating to FTP

| Category         | Content                               | Description   |
|------------------|---------------------------------------|---|
| FTP server error | Connection error to DNS server        | The FTP server or DNS server may be down.   |
|                  | Cannot connect to FTP server.         |   |
| Connection error | File transfer error                   | <ul style="list-style-type: none"><li>• The FTP server settings may be incorrect.</li></ul>                     |
|                  | Passive mode error                    | <ul style="list-style-type: none"><li>• The settings relating to the indicated item may be incorrect.</li></ul> |
|                  | Log out failed                        |   |
|                  | Directory change failed               |   |
|                  | User name and password isn't correct. |   |
| Internal error   | Other error                           | The FTP server settings may be incorrect.   |

## Error indications relating to DDNS

| Category         | Content                               | Description  |
|------------------|---------------------------------------|--|
| Connection error | Cannot connect to DDNS server.        | <ul style="list-style-type: none"><li>• The designated IP address of the DDNS may be incorrect. Check if the DDNS settings are configured correctly.</li><li>• The DDNS server may be down. Ask the network administrator.</li></ul> |
|                  | User name and password isn't correct. | Entered user name or password may be incorrect. Check if the DDNS settings are configured correctly.   |
|                  | IP address updated failed.            | IP address update error occurred in the DDNS server. Ask the network administrator.  |
| Internal error   | Other error                           | An error occurred in the DDNS function. Check if the DDNS settings are configured correctly.   |

## Error indications relating to NTP

| Category  | Content                       | Description  |
|---|-------------------------------|--|
| Connection error                                  | Cannot connect to NTP server. | <ul style="list-style-type: none"><li>• The IP address of the server may be incorrect. Check if the IP address of the server is configured correctly.</li><li>• The NTP server may be down. Ask the network administrator.</li></ul>     |
| Internal error                                    | Other error                   | <ul style="list-style-type: none"><li>• The designated IP address of the NTP server may be incorrect. Check if the DNS settings are configured correctly.</li><li>• The DNS server may be down. Ask the network administrator.</li></ul> |
| Time adjustment synchronizing with NTP succeeded. | Succeeded in the update.      | Time correction succeeded.   |



| Symptom                                  | Cause/solution   | Reference pages           |
|--|--|---------------------------|
| <p>Cannot access from the browser.</p>   | <ul style="list-style-type: none"> <li>• Is the same IP address provided to other devices?<br/>Are there contradictions between the address and the network subnet to be accessed?<br/>&lt;When the camera and the PC are connected in the same subnet&gt;<br/>Are the IP addresses of the camera and the PC set in a common subnet? Or is "Use Proxy Server" for the settings of the browser checked?<br/>When accessing the camera in the same subnet, it is recommended to enter the address of the camera in the "Don't Use Proxy For These Addresses" box.<br/>&lt;When the camera and the PC are connected in the different subnet&gt;<br/>Is the IP address of the default gateway set for the camera correct?</li> </ul> | <p>–</p>                  |
|  | <ul style="list-style-type: none"> <li>• Is the power of the camera on?<br/>Check if the power of the camera is turned on.</li> </ul>  | <p>Installation Guide</p> |
| <p>No image is displayed.</p>            | <ul style="list-style-type: none"> <li>• Is the viewer software installed on a PC?<br/>Install the viewer software on a PC.</li> </ul>   | <p>Installation Guide</p> |
|  | <ul style="list-style-type: none"> <li>• Is the version of DirectX 9.0c or later?<br/>Check the version of DirectX as follows.<br/>1. Select "Run..." from the start menu of Windows®.<br/>2. Enter "dxdiag" in the displayed dialog box and click the [OK] button.<br/><br/>If the version of DirectX is older than 9.0c, upgrade it.</li> </ul>  | <p>–</p>                  |
| <p>The image is not being refreshed.</p> | <ul style="list-style-type: none"> <li>• Depending on the version of your browser, there might be difficulties refreshing the picture and operating the camera.<br/>It is recommended to use Internet Explorer 6.0 SP2.</li> </ul>   | <p>Installation Guide</p> |
|  | <ul style="list-style-type: none"> <li>• Depending on the traffic of the network or the concentration of access to the camera, there might be difficulties displaying the camera picture. Click the reload button of the browser to request the camera picture to be refreshed.</li> </ul>   | <p>–</p>                  |

| Symptom   | Cause/solution  | Reference pages    |
|---|---|--------------------|
| Images are displayed blurry.  | <ul style="list-style-type: none"> <li>• Aren't there dusts or dirt on the dome cover?<br/>Check if there are dust or dirt on the dome cover.</li> </ul>  | –                  |
|   | <ul style="list-style-type: none"> <li>• Is the focus adjusted correctly?<br/>Check if the focus is adjusted correctly.</li> </ul>  | Installation Guide |
| Images cannot be saved on the SD memory card.                               | <ul style="list-style-type: none"> <li>• Is the SD memory card inserted correctly?<br/>Check if the SD memory card is inserted correctly.</li> </ul>  | Installation Guide |
|   | <ul style="list-style-type: none"> <li>• Is the SD memory card formatted?<br/>Format the SD memory card.</li> </ul>   | 19                 |
|   | <ul style="list-style-type: none"> <li>• Isn't the write protect switch set to "LOCK"?<br/>When the write protect switch is set to "LOCK", available size/total size indication of the SD memory card will be "*****KB/*****KB".</li> </ul>                                   | –                  |
|   | <ul style="list-style-type: none"> <li>• Isn't the SD memory card out of order?<br/>There are limited times to overwrite on an SD memory card. When frequently overwritten, it may be at the end of product life. It is recommended to replace the SD memory card.</li> </ul> | –                  |
| Unnecessary title bar is displayed when displaying images on a full screen. | <ul style="list-style-type: none"> <li>• Open the "Security" tab of "Internet options..." under "Tools" on the menu bar of Internet Explorer. Then, add the IP address of the camera to "Trusted sites".</li> </ul>   | –                  |
| No image is displayed on a full screen.                                     | <ul style="list-style-type: none"> <li>• Wasn't the [Esc] key pressed before images are displayed?<br/>Close the browser window by pressing the [Alt] key and [F4] key simultaneously, etc.</li> </ul>  | 7                  |

## Symptom

When displaying MPEG-4 images on two browser windows or more, images from two cameras or more are displayed in sequence on a single browser window.

## Cause/solution

- This may occur due to the display adapter and driver combination.

When this occurred, update the driver of the display adapter to the latest version first.

If updating the driver does not solve the problem, adjust the hardware acceleration as follows.

The following are descriptions for when Microsoft XP Professional SP2 is installed on the PC in use.

- (1) Right-click on the desktop and select "Properties" from the displayed pop-up menu.
- (2) Select "Settings" from "Display Properties", and then click the [Advanced] button.
- (3) Click the [Troubleshoot] tab and disable the DirectDraw acceleration by adjusting the level of "Hardware acceleration".

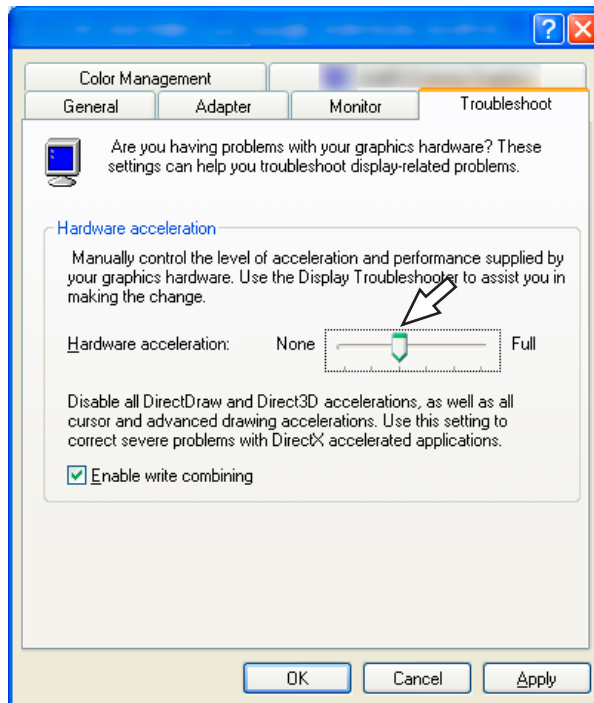

## Reference pages

## When using a PC on which Windows® XP Service Pack2 (SP2) is installed

The following may occur during operation when using a PC on which Windows XP Service Pack2 (SP2) is installed. Follow the instructions below when the following occurred. By performing the following solutions, other applications and the security level may not be affected.

The "Information Bar" expressed in the following symptom and solutions will be displayed just below the address bar only when there is information to communicate.

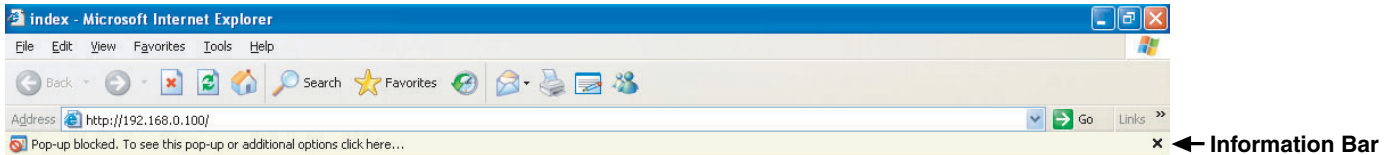

| Symptom   | Solutions  | Reference pages |
|---|--|-----------------|
| The following message is displayed on the information bar.<br>"Pop-up blocked. To see this pop-up or additional options, click here..."   | <ul style="list-style-type: none"> <li>Click the information bar and select "Always Allow Pop-ups from This Site...". The dialog window saying "Allow pop-ups from this site?" will be displayed. Click the [Yes] button.</li> </ul>   | -               |
| The following message is displayed on the information bar. "This site might require the following Active X control: 'nwc3setup.exe' from 'Matsushita Electric Industrial Co., Ltd'. Click here to install..." | <ul style="list-style-type: none"> <li>Click the information bar and select "Install Active X Control". The "Security Warning" window will be displayed. Click the [Install] button on the displayed "Security Warning" window.</li> </ul>   | -               |
| Unnecessary status bar or scroll bar is displayed on the pop-up window.   | <ul style="list-style-type: none"> <li>Click "Internet Options" on the Tools menu of Internet Explorer, and then click the [Security] tab. Then, click the [Custom Level...] button to open the "Security Setting" window. Under "Miscellaneous", select "Enable" for "Allow script-initiated windows without size or position constraints". Click the [OK] button. The "Warning" window will be displayed. Click the [Yes] button.</li> </ul> | -               |
| Images are not displayed or refreshed smoothly.   | <ul style="list-style-type: none"> <li>Delete temporary internet files as follows.               <ol style="list-style-type: none"> <li>Select "Internet Options..." from "Tools" on the menu bar of Internet Explorer®. The "Internet Options" window will be displayed.</li> <li>Click the [Delete Files...] button in the "Temporary Internet files" section on the [General] tab.</li> </ol> </li> </ul>                                   | -               |

**Matsushita Electric Industrial Co., Ltd.**

Osaka, Japan

<http://panasonic.net>