



INSTRUCTION MANUAL



**SIMRAD GC80/85
COMPACT**

Gyro Compass

20221511D

English

Document revisions

Rev	Date	Written by	Checked by	Approved by
A	19.12.03	<i>J.P.</i>	<i>V.P.</i>	<i>V.P.</i>
B	17.02.05	<i>J.P.</i>	<i>Jan Magnus Eik</i>	<i>R. Schrey</i>
C	05.12.05	<i>J.P.</i>	<i>Jan Magnus Eik</i>	<i>R. Schrey</i>
D	09.05.07	<i>J.P.</i>	<i>Jan Magnus Eik</i>	<i>R. Schrey</i>

Document history

Rev. A	First issue.
Rev. B	Updated for new software release (Master compass: V.1.03, Control unit: V.1.04).
Rev. C	New procedure for how to adjust true heading, updated dimensions for remote panel, other minor updates to text throughout the manual.
Rev.D	Text and illustration updates.

About this manual

This manual is intended as a reference guide for installing, operating and maintaining Simrad GC80 and GC85 Compact Gyro compasses.

The manual assumes that the operator is a qualified ship officer, or is under supervision of a qualified person.

In this manual, references to buttons on the operator panels are written in boldface, but in a different text style (e.g. **SET** button, **DISP** button, **GYRO** button).

Important text that requires special attention from the reader is emphasized as follows:

Note! *Used to draw the reader's attention to a comment or some important information.*

Caution *Used for warning the reader that a risk of damage to the equipment exists if care is not exercised.*

WARNING **Used when it is necessary to warn personnel that a risk of injury or death exists if care is not exercised.**

This manual is divided in the following sections:

1. System overview

An overview of the GC80/GC85 Compact gyro system and it's components.

2. User interface

Overview of GC80 Compact Control unit and the user interface.

3. Operation

Main operating procedures for using the GC80/GC85 Compact Gyro compass.

4. Maintenance

Simple maintenance procedures that should be performed by the system operator, together with a complete procedure for how to replace the sensitive element and fuses.

5. Installation

Mechanical installation, cable connection, and software configuration for the GC80/GC85 Compact gyro system.

6. Advanced settings

A description of parameters that can be entered or changed in the Extension menu.

7. Technical specifications

Specifications for the system and for all separate units in the GC80/GC85 Compact gyro system.

8. Drawings

Outline drawings and wiring diagrams for the GC80/GC85 Compact gyro system.

9. Spare part list

List of all standard and optional units that are used in the GC80 and GC85 Compact gyro systems.

10. Terminal layout

List of all terminal pins and terminal labelling with details on pcb's in the GC80 Control unit.

11. Dip switch settings

Drawings and references of jumpers and dip switches for the different printed circuits boards in the Control unit.

12. Alarm messages and corrective actions

A description of how system errors are indicated, and corrective actions that can be performed by the operator.

Contents

1	SYSTEM OVERVIEW	1
1.1	Introduction.....	2
1.2	Precaution in use.....	3
1.3	System components.....	4
1.4	Bearing repeaters	4
2	USER INTERFACE	5
2.1	GC80 Compact Control unit	6
3	OPERATION	9
3.1	System Start-up and Shut-down.....	10
	Start-Up	10
	Turning the Gyro compass OFF.....	11
3.2	Selecting active compass	12
3.3	Adjusting dimming level	12
3.4	Displaying present settings	13
	Displaying settings <u>with no</u> external sensor connected.....	13
	Displaying settings <u>with</u> external sensor connected	14
3.5	Confirming present settings	16
	True bearing.....	16
	Latitude	16
	Speed.....	17
3.6	Pendulum function	19
3.7	Alarm messages.....	20
	Acknowledging an alarm	21
4	MAINTENANCE	23
4.1	General.....	24
4.2	Precautions.....	24
4.3	Cleaning the operator panels and the cabinet surface	24
4.4	Checking the connectors.....	24
4.5	Checking mechanical installation.....	24
4.6	Preventive maintenance intervals.....	25
4.7	Replacing the Sensitive element	25
	Mechanical installation	25

	Verifying the element's tilt angle	29
	Parameter updates	30
	Balancing the Horizontal ring	31
4.8	Replacing the Fuses	32
	Master Compass.....	32
	Compact Control unit	32
	Power Supply Unit (Option)	34
5	INSTALLATION.....	35
5.1	Unpacking and handling	36
5.2	Mechanical installation	36
	Control unit	37
	Power supply unit (Option)	39
	Master compass	40
5.3	Cabling	41
5.4	Grounding the units	42
5.5	Dip-switch and jumper settings	42
	Activating the control unit for GC80 or GC85 system	43
	Activating an external heading sensor	44
	Activating the pendulum function	44
5.6	Installing the Sensitive element	45
	Verifying the element's tilt angle	47
5.7	System start-up and software configuration	49
	System Start-up	49
	Configuring the gyro system	50
	Setting the Latitude input source	52
	Setting the Speed input source	53
5.8	Balancing the Horizontal ring.....	54
	Adjusting True heading	54
6	ADVANCED SETTINGS	57
6.1	General.....	58
6.2	Using the Extension menu	58
6.3	The Extension menu overview	59
7	TECHNICAL SPECIFICATION	65
7.1	Accuracy	66
7.2	General specification	66

7.3	Input specification	67
7.4	Output specification	68
7.5	Physical Dimensions.....	69
	GC80 Master Compass	69
	GC80 Compact Control Unit	69
	GC80 Power Supply unit (option)	69
7.6	Power	69
	GC80/85 Master Compass	69
	GC80 Compact Control Unit	70
	GC80 Power Supply unit (option)	70
7.7	Environmental Specification	70
	GC80/85 Master Compass	70
	GC80 Compact Control unit	70
8	DRAWINGS	71
8.1	Drawings included	72
9	SPARE PART LIST	79
9.1	GC80 Compact Gyro system.....	80
9.2	GC85 Compact Gyro system.....	80
9.3	GC80/GC85 Optional equipment	81
10	TERMINAL LAYOUT	83
10.1	ITERM board	84
	TB1	84
	TB2	85
	TB3	86
10.2	IOPT board	87
	TB3	87
	TB4	87
11	DIP SWITCH SETTINGS	89
11.1	Compact control unit.....	90
	ICIF board.....	91
	IOPT board.....	94
	ITERM board.....	96
12	ALARM MESSAGES AND CORRECTIVE ACTIONS.....	97
12.1	The alarm system.....	98

12.2	Acknowledging an alarm.....	99
12.3	Fault finding	100
	Main power failure.....	100
	Internal power failure in Control unit.....	101
	Inverter failure	101
	Zero cross failure	101
	System communication failure	102
	GPS communication or data failure	102
	Internal communication failure.....	103
	External bearing sensor failure	103
	LOG (serial) communication or data failure	103
	Repeater failure	104
	Failure when powering ON the gyro compass	104
12.4	Complete alarm code list	105

1 SYSTEM OVERVIEW

This section provides an overview of GC80 and GC85 Compact Gyro compasses and their components.

1.1 Introduction

GC80 and GC85 Compact Gyro compasses have been designated for any size of vessels to enhance the navigation capabilities and reliability. The gyro compasses eliminate the inconvenience and limitations of magnetic compasses, and provide a variety of electrical outputs to supply accurate and consistent heading information to other navigational equipment.

- A GC80 Compact gyro is designed for vessels with speed up to 30 knots. The system complies with IMO A.424 (11) and Wheel Mark Specifications.
- A GC85 Compact gyro system is suitable for high speed vessels with speed up to 70 knots. It complies with IMO A.821 (19) HSC.

GC80 and GC85 Compact gyro systems have different sensitive elements, but use the same GC80 Compact Control unit. The systems are identified with divergent dip switch settings in Master compass and in the Control unit.

Note!

A GC80 or GC85 system is identified by the labelling on top of the Master compass' case as shown on the figure below. The labelling on the control unit is identical for both gyro systems.

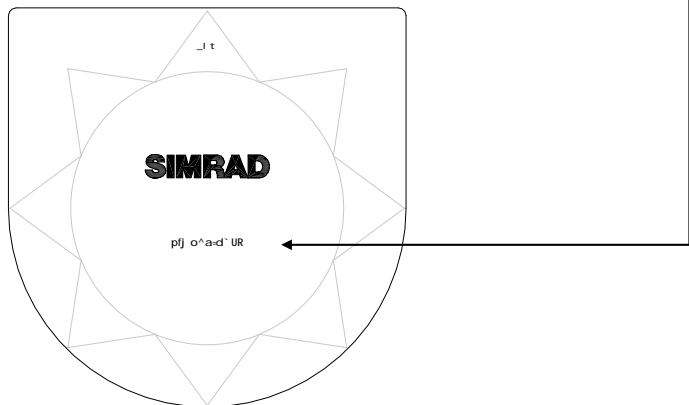

1.2 Precaution in use

The GC80/GC85 Compact Gyro compass displays and outputs bearing information. Although the system continually checks for faults while the system is running, failures or malfunctions may occur.

Any errors in input information will generate an alarm. These errors may also cause large jumps in the output bearing from the gyro compass. If this happens, any external equipment depending on the bearing output from GC80/85 should be operated manually or switched to other bearing sensors.

To assure long time safe operation, the following precautions should be taken:

- Assure that the operator is familiar with the use of the gyro compass
- Perform daily check to maintain normal system operation. Refer *MAINTENANCE*, page 23 onwards
- If any unusual behavior is observed during daily inspection, the cause should be found and corrected. If necessary, the local Simrad dealer should be contacted
- If any alarm is generated, verify the reason for the alarm

1.3 System components

A GC80/GC85 Compact Gyro compass includes the following units:

- Master Compass with Sensitive Element
- Compact Control unit
- Power Supply unit (Option)

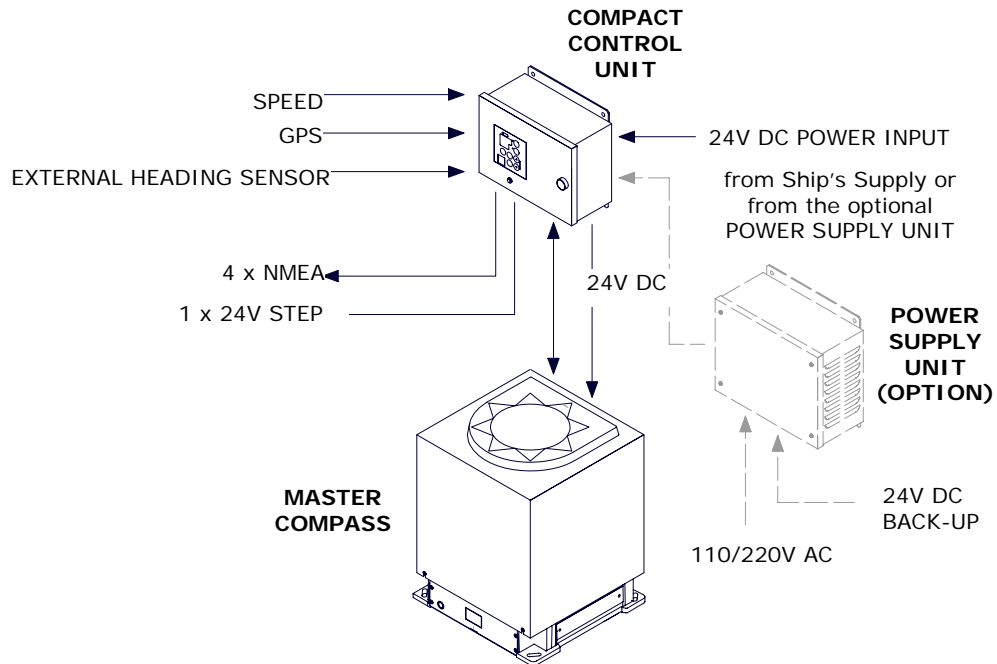

Note! For details, refer *TECHNICAL SPECIFICATION*, page 65.

1.4 Bearing repeaters

GC80 and GC85 outputs step and serial signals used for repeaters. Even when the gyro compass is supplied by the emergency power supply, the connected repeaters will be driven by the repeater backup function included in GC80/GC85.

The following serial signal may be selected:

- Lo speed: IEC61162-1 ed.2, close in comparison with NMEA0183 version 2.30 (4800 baud)
- High speed: IEC61162-2, based upon NMEA0183 version 2.30 (4800 and 38400 baud possible)

Note! A proprietary Tokimec serial signal may also be available, but this is normally not used.

These signals may be set separately for each circuit. For connection of repeaters, refer to wiring diagrams, page 72 onwards.

2 USER INTERFACE

This section gives an overview of the GC80 Compact Control unit and the user interface.

2.1 GC80 Compact Control unit

The Control unit includes the control panel for the gyro compass.

A flush mount kit (part number 27101757) may be ordered from Simrad for remote installation of the control panel. Refer *Flush mounting the control panel*, page 37.

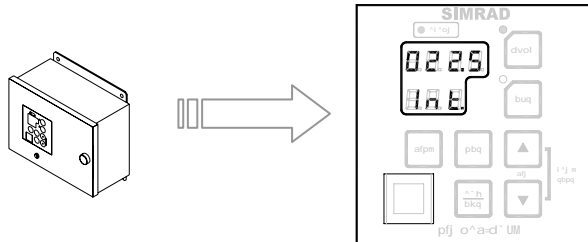

POWER Button



Used for switching the gyro system ON. The button will be lit to indicate that power is applied to the system. Refer *System Start-up and Shut-down*, page 10.

Display

The LCD displays data in two rows: the upper row shows data and the lower row shows active mode.

- The Data indicator consists of four 7-segments red LEDs. The indicator is used for displaying the vessel's bearing, latitude and speed. Refer *Displaying present settings*, page 13.
The Data indicator is also used for displaying alarm codes as described from page 19 onwards.
- The Mode indicator consists of three 7-segments green LEDs. The Mode indicator displays codes used for identifying input type for bearing, latitude and speed.

GYRO Button



Used for selecting the gyro compass as the active heading reference source. The status lamp is lit to indicate that the gyro system is active.

Refer *Selecting active compass*, page 12.

EXT Button



Used for selecting the external heading source as the heading reference. The status lamp will be lit to indicate that the external heading reference source is active.

Refer *Selecting active compass*, page 12.

DISP Button



Used for displaying data on the LCD. Refer *Displaying present settings*, page 13.

SET Button



Used for changing data and input sources. Refer *System start-up and software configuration*, page 49 onwards.

ACK/ENT Button



Used for confirming a change in data and input sources. Refer *System start-up and software configuration*, page 49 onwards.

The button is also used for acknowledging an alarm as described in *Acknowledging an alarm*, page 21.

Arrow Buttons

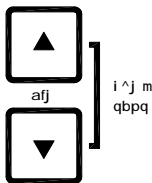

Used for increasing or decreasing a parameter value. Refer *System start-up and software configuration*, page 49 onwards

Also used for lamp test and for setting the display illumination as described in page 12.

Alarm Indicator



Used for indicating an alarm situation. Refer *Alarm messages*, page 20.

**THIS PAGE INTENTIONALLY LEFT
BLANK**

3 OPERATION

This section describes the main operating procedure used when operating the GC80/GC85 Compact Gyro compass.

3.1 System Start-up and Shut-down

A GC80/GC85 Compact gyro system is usually left with power on. If the system has to be shut down and restarted, the procedures in the following sections should be followed.

Start-Up

Caution

Before the gyrocompass is turned into normal operation, it has to be configured according to the description in System start-up and software configuration, page 49 onwards.



Turn ON the gyro system by pressing the **POWER** button on the Control panel. The following start-up sequence will be run:

- Control unit type (GC80 Std, or GC85 HSc), SW version for Control unit and for Master compass is displayed in rapid succession. Examples of display text are shown below:

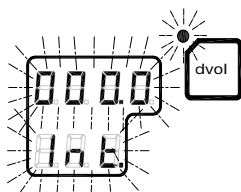
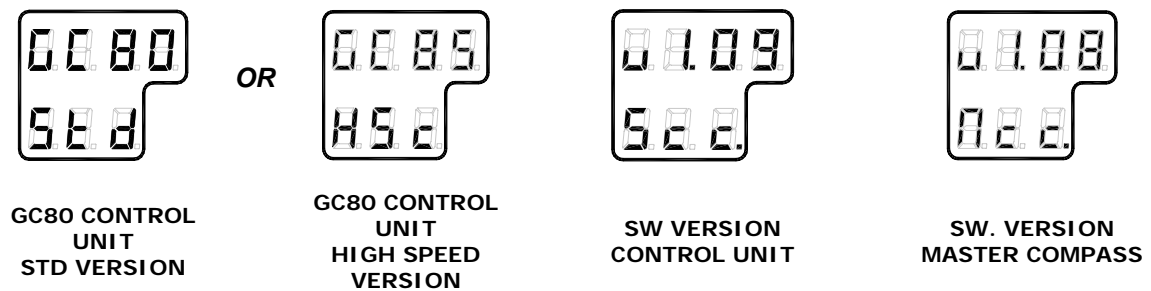

- If the rotor was not completely stopped when the **POWER** button was pressed, a rotor break function will be activated to stop the rotor.

Active rotor break is indicated with flashing display.

- When the turning stops, the sensitive element starts rising horizontally and the compass rotates 360° clockwise. The display shows decreasing bearing as the compass is turning.

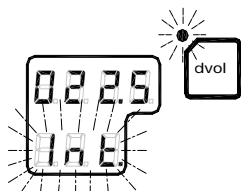

- When the compass has rotated 360°, start bearing is indicated with flashing text in the display. The start bearing will be the same as active bearing when the compass was turned OFF.

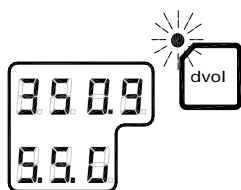

- 5 The indicated start bearing is accepted by pressing the **ACK/ENT** button, or increased/decreased by using the arrow buttons and then pressing the **ACK/ENT** button. If no action is taken within 3 minutes, the start-up process will continue with the indicated start bearing. The bearing indication stops flashing when the start bearing is accepted, while the lamp remains flashing.

- 6 The rotor will now start rotating, and reaches full speed after maximum 30 minutes.

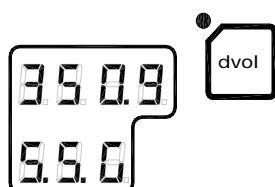

- 7 When the rotor has reached full speed, the compass starts the north seeking function. The display will now change to show the compass' actual heading, and from now on bearing output will be available.

The lamp near the **GYRO** button change from flashing to steady light.

The GC80/GC85 will be settled within 3 hours when started with a deviation angle less than 5°. With a larger deviation angle, the compass will be settled within 4 hours.

Turning the Gyro compass OFF

- 1 Press the **POWER** button on the Control panel. The light in the **POWER** button will be switched off.
- 2 Repress the **POWER** button to activate the rotor break function. The light in the **POWER** button will be lit again.

Active rotor break is indicated by:

- flashing display
- a soft clicking sound heard from the gyrocompass

The rotor break function will be active for maximum 4 minutes.

Caution

It is very important that the rotor break is activated to stop the rotor rotation to prevent any possible damage by ship's movement!



- 3 Press the **POWER** button again to shut down the gyrocompass when both the data and the dot in the display change from flashing to steady light.

The light in the **POWER** button will now be turned OFF.

3.2 Selecting active compass

If an external heading sensor is connected to GC80/GC85, it is possible to switch between gyro and external heading sensor as active steering sensor.

The gyro system will normally be used with the gyro compass selected as active compass. An external heading sensor should only be used as active compass when the gyro compass not is working properly.

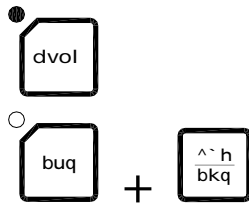

By pressing the **GYRO** or the **EXT** and the **ACK/ENT** buttons simultaneously, the GC80/GC85 will toggle between using the gyrocompass or an external sensor as active sensor.

When the active sensor is changed, an audible alarm will sound three times.

Active compass is identified with light in the button's indicator lamp, and with active compass type in the LCD as shown in the figures below.

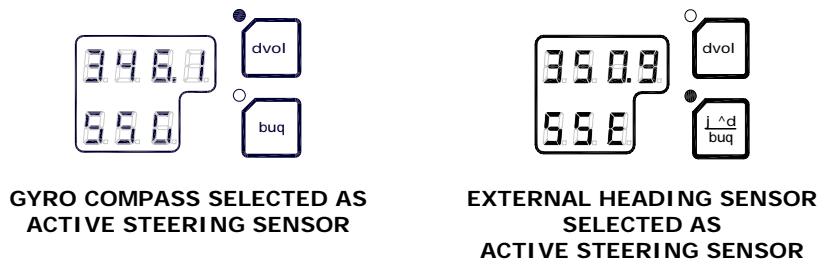

GYRO COMPASS SELECTED AS ACTIVE STEERING SENSOR

EXTERNAL HEADING SENSOR SELECTED AS ACTIVE STEERING SENSOR

WARNING

Changing active compass may result in large change of true bearing. No changes should therefore be made when the system is in operation.

3.3 Adjusting dimming level



The display illumination and the light intensity in the indicator lamps can be increased or decreased in 5 steps by pressing the arrow buttons.

When the illumination is set to lowest level, a faint light is still present in the display, Alarm indicator, status lamp and Power button.

Panel lamps and display segments may be tested by pressing both arrow buttons simultaneously. All lamps and display segments will be lit, and a short audible alarm will be activated.

3.4 Displaying present settings

When pressing the **DISP** button on the GC80 Control unit, the system will loop through a display sequence showing present settings for the system.

The sequence will be depend on whether an external compass is connected or not. When an external compass is connected, the readout will depend on active compass.



The following sections; *Displaying settings with no external sensor connected* and *Displaying settings with external sensor connected*, show examples of how the present settings are presented by pressing the **DISP** button.

The display will be used as follows:

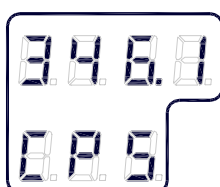





← - The first row in the display will show the value



← - The second row displays code used for identification

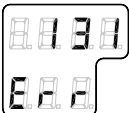

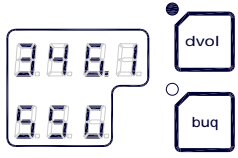



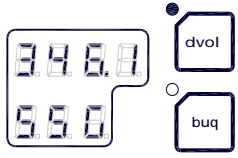
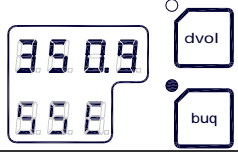

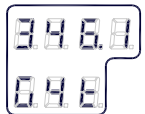

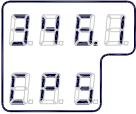
Displaying settings with no external sensor connected

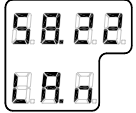
Display state	Display	Description
Normal operation	The display shows '348.1' on the top line and '550' on the bottom line. To the right of the display are two icons: 'dvol' with a dot and 'buq' with a circle.	<ul style="list-style-type: none"> - True output bearing - Active compass
1 st press on DISP button	The display shows '348.1' on the top line and '0.2.5' on the bottom line.	<ul style="list-style-type: none"> - Gyro compass bearing without correction - Active speed input source indication (GPS, Manual, Log or Serial Log)
2 nd press on DISP button	The display shows '58.22' on the top line and '0.2.5' on the bottom line.	<ul style="list-style-type: none"> - Latitude - Latitude indication: North (LA.n) or South (LA.s)
3 rd press on DISP button	The display shows '005.0' on the top line and '4.5.8' on the bottom line.	<ul style="list-style-type: none"> - Vessel speed - Speed input indication (GPS, Manual, Log or Serial Log)

Display state	Display	Description
 4 th press on DISP button		<ul style="list-style-type: none"> - Rate of turn in °/min - Rate of turn indication
 5 th press on DISP button		<ul style="list-style-type: none"> - Error codes (up to 4) - Error indication
 6 th press on DISP button Normal operation		<ul style="list-style-type: none"> - True output bearing - Active compass

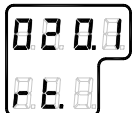
Displaying settings with external sensor connected

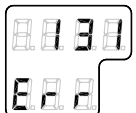
Display state	Display	Description
Normal operation	 or 	<ul style="list-style-type: none"> - True output bearing - Active compass <p>The compass indication equals the sensor selected as active compass (gyro or external)</p>
 1 st press on DISP button	 or 	<ul style="list-style-type: none"> - Bearing - Passive compass

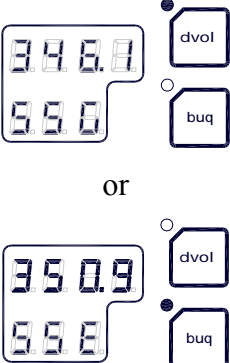
Display state	Display	Description
 2 nd press on DISP button		<ul style="list-style-type: none"> - Gyro compass bearing without correction - Active speed input source indication (GPS, Manual, Log or Serial Log)
 3 rd press on DISP button		<ul style="list-style-type: none"> - Latitude - Latitude indication: North (LA.n) or South (LA.s)
 4 th press on DISP button		<ul style="list-style-type: none"> - Vessel speed - Speed input indication (GPS, Manual, Log or Serial Log)
 5 th press on DISP button		<ul style="list-style-type: none"> - Rate of turn in °/min - Rate of turn indication
 6 th press on DISP button		<ul style="list-style-type: none"> - Error codes (up to 4) - Error indication
 7 th press on DISP button Normal operation		<ul style="list-style-type: none"> - True output bearing - Active compass

3.5 Confirming present settings

After the GC80 is configured according to the *System start-up and software configuration*, described in page 49 onwards, it should not be necessary to adjust any settings when operating the gyro compass.

However, if an error is reported in any of the input sources, it may be necessary to switch to a different input source.

True bearing

Make sure that the gyro compass is selected as active compass. Refer *Selecting active compass*, page 12.

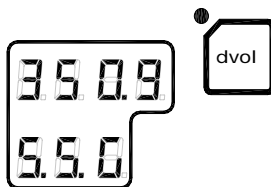

Confirm that the gyro compass's displayed true bearing is according to a known target or astronomical observation.

If there is any difference, adjust the bearing according to *Adjusting True heading*, page 54.

Latitude

Press the **DISP** button until the vessel's latitude is displayed.

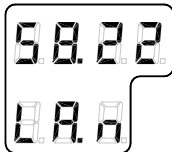

The displayed latitude value is calculated based on the vessel's true bearing and the vessel's actual speed. Refer setting the latitude input source and speed input source, page 52 onwards.

- If GPS is selected as latitude input source, the latitude obtained from the GPS is displayed on the LCD. Confirm that the displayed latitude is the same as indicated on the GPS indicator.
- If GYRO (manual setting of latitude) is selected as latitude input source and other than MANUAL selected as the vessel's speed input source, the latitude will be automatically updated. In this case, the indicated latitude should be confirmed every 4th hour when the vessel is in harbor. If there is any significant difference between the displayed value and the vessel's actual latitude, the value should be adjusted according to *Setting the Latitude input source*, page 52.

Note!

When *GYRO* is selected as latitude input source and *MANUAL* is selected as the speed input source, the indicated latitude value will not be updated and hence an error may build up.

Speed

The GC80/GC85 gyro compass calculates bearing based on the speed and latitude information that is input to the gyro as speed source. Any error in speed input will therefore cause incorrect true bearing from the gyro compass.

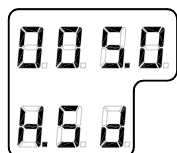

Press the **DISP** button until the vessel's speed information is displayed.

Confirm in 4 hours intervals that the displayed speed is the same as the vessel's actual speed.

Any discrepancy between displayed speed and actual speed is corrected as described in *Setting the Latitude input source*, page 53.

Speed error correction

All gyro compasses will generate a heading error caused by the vessel speed and earth rotation. GC80/GC85 calculates this error based on latitude and speed input information, and corrects automatically the bearing signal output. If no speed information is available, the gyro compass will output a heading error either westwards or eastwards depending on the vessel's course.

If speed information is unavailable, the figure on next page may be used for manually calculating the heading error.

In this figure, the following values are used as example:

- Latitude: 40°
- Vessel speed: 16 knots
- Vessel heading: 30°

The heading error is found by:

- 1 Drawing a line between the latitude and the vessel heading (shown with gray line on the figure)
- 2 Drawing a straight line (broken line in the figure) between the vessel speed and the point where the latitude/heading line intersects with the solid black line in the figure.

In the example above, the figure shows a speed error of appr. 1.1°, and the true bearing should then be $30^\circ - 1.1^\circ = 28.9^\circ$.

Note!

*When the course is within 270° - 0° - 90°, true heading is found by subtracting the speed error from the compass heading.
If the course is within 90° - 180° - 270°, true heading is found by adding the speed error to compass heading.*

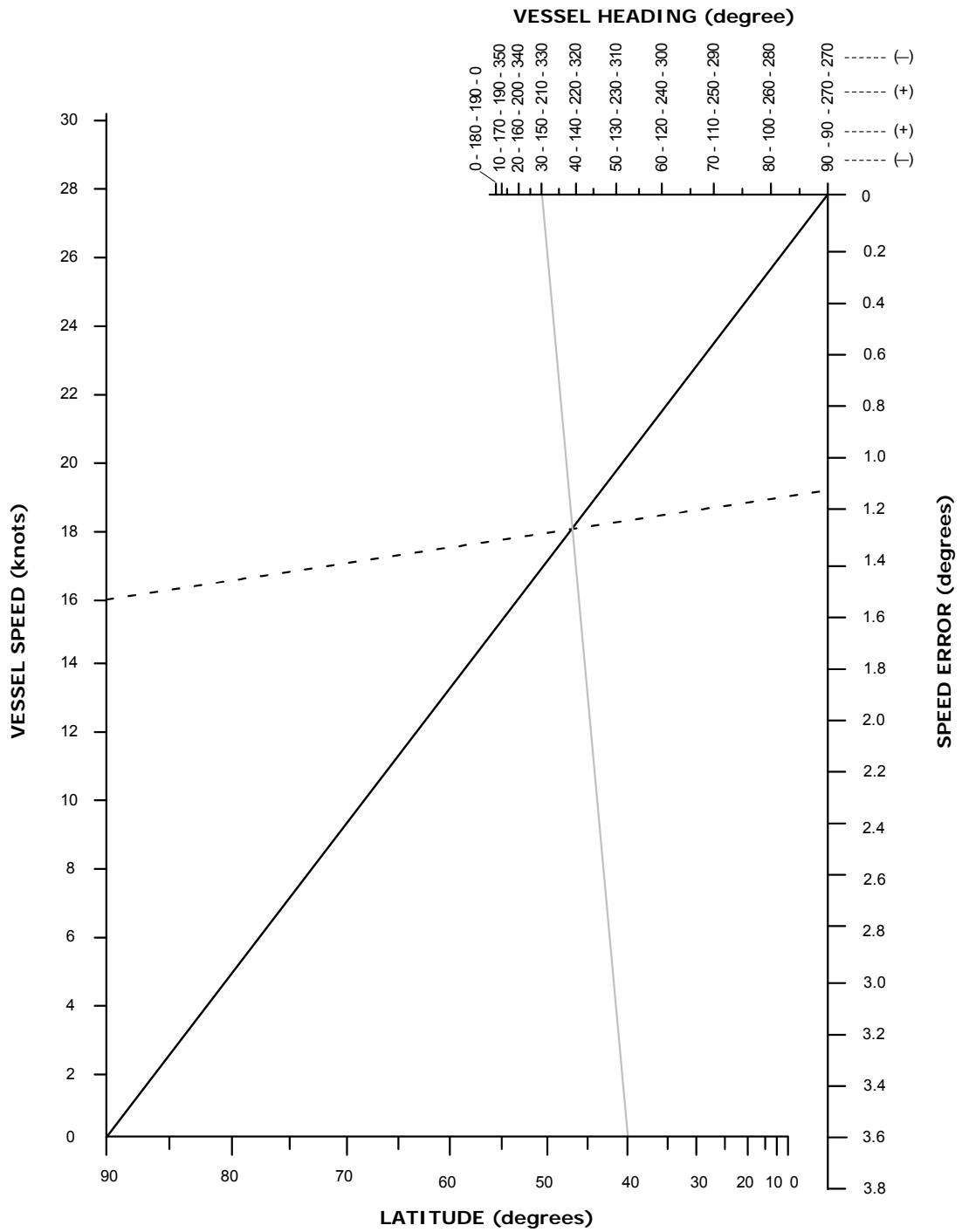

3.6 Pendulum function

GC80/85 software includes a pendulum function that enables the heading to be changed by 180°.

The heading change is activated by closing a potential free contact connected between TB1, pin 25 and 26 in GC80/85 control unit.

Note!

*To enable the function, S2-4 on the ICIF board has to be set to ON. Refer **DIP switch settings on ICIF board**, page 91 onwards.*

When the switch is set to activate the function, the following functions are obtained:

- The compass heading and repeaters change by 180° from the heading
- An acoustic alarm sounds 5 times
- The dots in the indicator field in the display starts flashing. These will remain flashing for as long as the pendulum function is active.

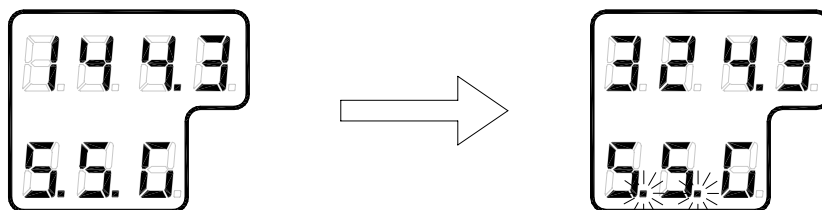

Normal compass operation is resumed by opening the closed potential free contact. The function is indicated by the same acoustic alarm, and the flashing dots returns to fixed illuminated dots.

3.7 Alarm messages

The GC80/GC85 system will continually check for faults while the system is running.

If a fault occurs, an alarm code will be displayed in the LCD, the Alarm lamp will be flashing, and an audible alarm will be activated.

Up to 4 alarm codes may be displayed in the LCD to indicate that several alarm situations are present. The last activated alarm will be displayed on the right side of the display. The figure shows that alarm with code 1, 3 and 2 were generated in that order.

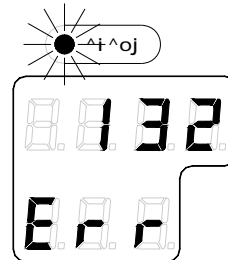

If more than 4 alarms are active, this will be indicated with a dot behind the last number as shown on the figure below. Further alarm codes may then be displayed by pressing the “arrow up” button.

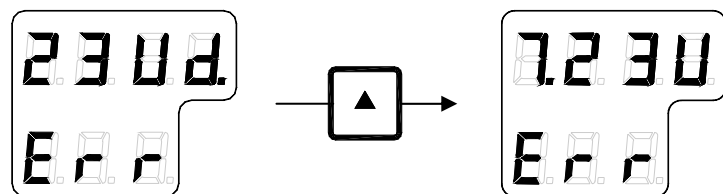

The example shows that alarm code 2, 3, U, d and 7 were activated.

Caution

When an alarm is generated, bearing information from the GC80/GC85 may not be present or may have large error. Any equipment using bearing information from the gyro compass should therefore immediately be operated according to the equipment’s emergency operating procedure.

Acknowledging an alarm



An alarm is acknowledged by pressing the **ACK/ENT** button.

- The audible alarm will be silenced
- If the alarm situation has disappeared, the alarm lamp will be switched off, and the alarm code will be removed from the LCD
- If the alarm situation continues, the alarm lamp will switch from flashing to steady light. The LCD will return to show true bearing with flashing numbers to indicate that the bearing may have large errors

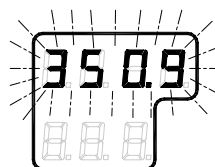

An alarm code for an active error may be recalled by pressing the **DISP** button until the alarm display is shown. It is possible to recall any alarm code in the LCD for as long as the alarm situation is present.

The *Complete alarm code list* section, page 105, has a complete list of alarm codes.

**THIS PAGE INTENTIONALLY LEFT
BLANK**

4 MAINTENANCE

This section holds descriptions for maintenance procedures that should be performed by the system operator.

The section also includes a detailed description for how to replace the sensitive element and the fuses.

4.1 General

All units in the GC80 system are designed for optimum safety and reliability. However, a limited amount of preventive maintenance should be performed to verify safe operation and durability.

If any strange motion, smell, sound or heat is generated from any unit, a Simrad dealer shall be contacted.

4.2 Precautions

Touching internal parts may cause electric shock if power is connected to the system, even if the **POWER** button is turned OFF. Do not touch any terminal board or power supply unit when maintaining and checking the system. If necessary, disconnect the power cable from the Control unit.

Electrostatic charges may damage components on the circuit boards inside the units. Always wear a correctly connected earthing strap when opening the units.

4.3 Cleaning the operator panels and the cabinet surface

Use a vacuum cleaner with a soft brush to avoid damage to the buttons and the panel. If required, clean the buttons and panel with a non-abrasive cloth moistened with mild soap solution.

4.4 Checking the connectors

The connectors should be checked by visual inspection only. Push the connector plugs into the connector. If the connector plugs are equipped with a lock, ensure that this is in correct position.

4.5 Checking mechanical installation

Vibration and shock may cause mechanical parts to loosen. All fastening screws should therefore regularly be checked and eventually tightened.

4.6 Preventive maintenance intervals

Local evaluations should be made to determine site-specific maintenance intervals.

ACTION	INTERVAL RECOMMENDED
Confirm that the value of each repeater synchronizes with the displayed true bearing on the Operator panel.	Daily
Confirm that the displayed latitude and speed is according to the vessel's actual latitude and speed.	Daily
Check connectors	Every six month
Tighten fastening screws	Every six month
Clean panels and cabinet	Once a year or as required
Clean slip rings and brushes. Apply lightly "27102128 gyro slip ring lubrication oil".	Every second year

4.7 Replacing the Sensitive element

Caution *The Sensitive element should only be replaced by authorized Simrad personnel.*

Note! *A special tool is required when installing the Sensitive element. This tool is optional and must be ordered from Simrad (part no. 44174449).*

Mechanical installation

Caution *Use extreme caution when handling the Sensitive element! Do not tilt the element. It is filled with oil and the top includes a ventilation opening.*

- 1 Ensure that the power is disconnected from the Control unit.
- 2 Remove the four screws securing the compass case, and lift the case carefully upwards and away.

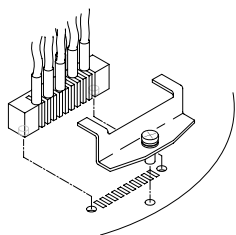

3 Loosen the screw on the plug-holder on the Sensitive element, and disconnect the plug.

4 Remove the four screws securing the Sensitive element. Tilt the Horizontal ring to the side where the plug is located, and carefully remove the element from the compass.

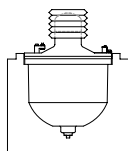
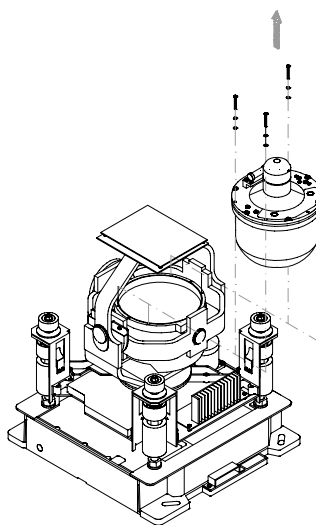

5 Place the defective Sensitive element in its original package, and put the rubber tube on top of the element.

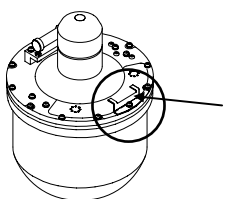

6 Fasten the screw on the plug holder on the defective Sensitive element.

7 Lift the new element carefully from its package, and remove the rubber tube on top of the element.

Note!

The package and the rubber tube should be kept for re-use if the Sensitive element has to be sent to factory for service!

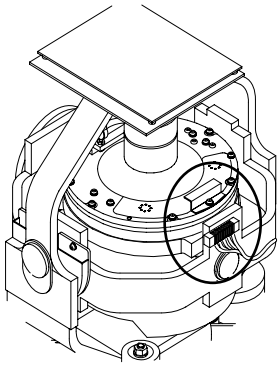

8 Tilt the Horizontal ring to the side where the plug is located, and carefully put the sensitive element into the ring.

- The socket on the Sensitive element should be located right above the plug attached to the Horizontal ring.

9 Position the Sensitive element on the Horizontal ring by putting the assembly jigs into the holes as indicated on the figure below. Observe the rings on the jigs to ensure proper positioning. Insert and fasten the two screws in the other holes.

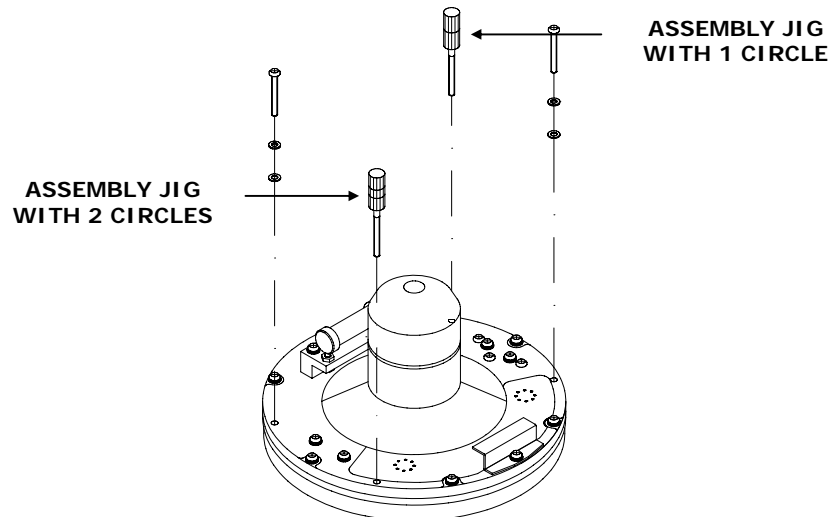

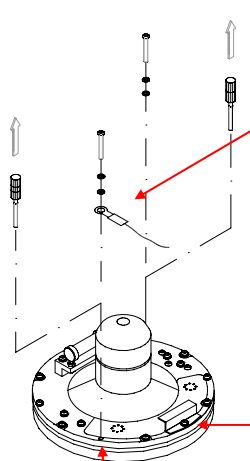
- 
- 10** Replace the assembly jigs with the two remaining screws after placing the ground wire as shown on the figure.
- 11** Loosen the screw on the plug holder on the Sensitive element, and lift the holder 2-3 mm upwards.
- 12** Connect the plug to the connectors on the Sensitive element's pcb according to the labelling on the pcb and on the wires. Make sure that the pin guides on the plug are properly entered, and that the wires are not twisted.
- 13** Firmly tighten the screw on the holder.

Ground wire connection

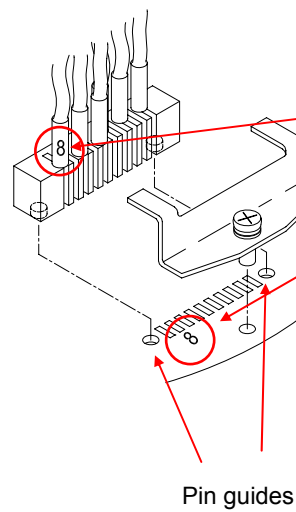

Verifying the element's tilt angle

- 1 Tilt the Sensitive element by hand towards the level tool on the Horizontal ring and keep it tilted for approximately 1 minute. Remove the pressure and observe that the tilt angle remains at:
 - GC80: 15° to 19°
 - GC85: 18° to 22°

The tilt angle is indicated on the figures below.

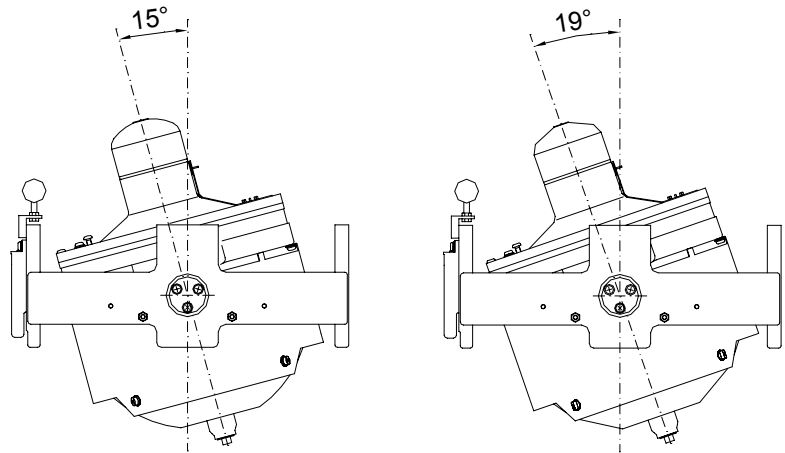

Max and min tilt angle for GC80 std system

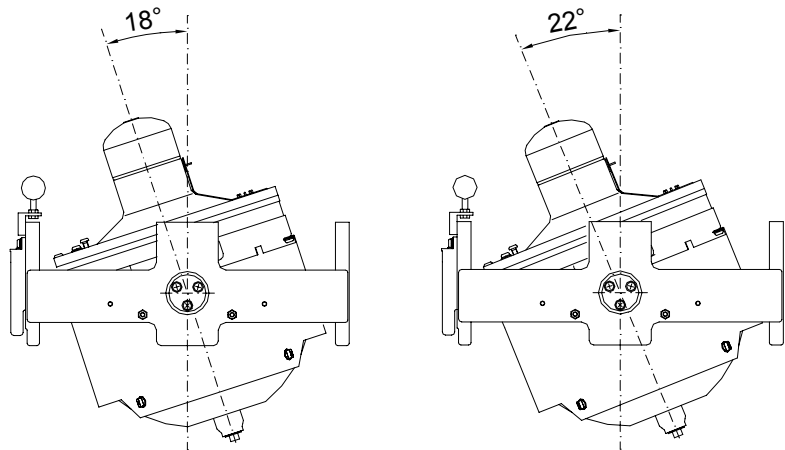

Max and min tilt angle for GC85 High Speed system

Note!

The tilt angle shown above is correct for cold condition. The angle may change when the element has reached normal operational temperature!

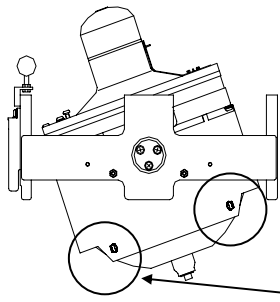

- 2 If the tilt angle is incorrect, weight disks must be adjusted by moving weights from one side to the other. After adjustments, wait for 2 minutes for the oil to set before the tilt angle verification is repeated.

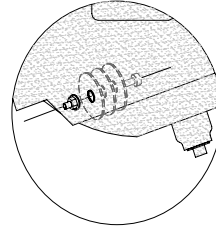

Caution

The sensitive element must have equal number of weight disks on both weight points on the tilting side (north and south side)!

- 3 Carefully rotate the Horizontal ring at least one complete rotation. Verify that all movable parts will rotate without making mechanical or electrical contact with any item or component.

Parameter updates

When a sensitive element is replaced, parameters for the new element have to be loaded into the GC80 Control unit before the gyro compass is started. This is done from the Extension menu as described below.

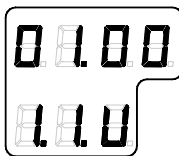
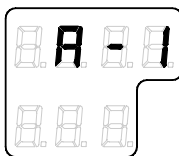

- 1 Enter the Extension menu by pressing and holding the **SET** button and the **ACK/ENT** buttons simultaneously for appr. 3 seconds.
Main category **A-1** will be displayed.
- 2 Press the **SET** button to enter the sub-category loop. Sub-category **1.1.U** and its parameter values will be displayed.
- 3 Use the arrow buttons to increase or decrease the parameter value until the value is according to the table supplied with the new sensitive element.
- 4 Confirm the entry by pressing the **ACK/ENT** button. The display will return to sub-category **1.1.U**, and the data will be transferred to the gyro immediately.
- 5 Press the **DISP** button again to select sub-category **1.6.t**, and use the arrow buttons to increase or decrease the parameter value until the value corresponds with the parameter for the new sensitive element. Confirm the entry by pressing the **ACK/ENT** button.

- 6 Exit the sub-category by pressing the **SET** button, and then exit the Extension main category by pressing and holding the **SET** and **ACK/ENT** buttons simultaneously for appr. 3 seconds.

For more information about the Extension menu, see *ADVANCED SETTINGS*, page 57 onwards.

Balancing the Horizontal ring

After the Sensitive element has been replaced, the gyro compass should be started as described on page 10.

When the compass has been running continuously for at least 2 hours, the horizontal ring should be adjusted.

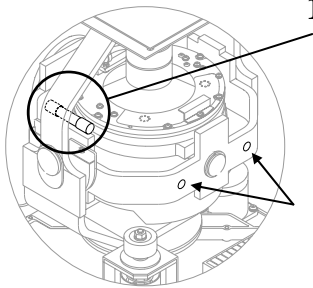

- 1 Locate the reference level tool on the horizontal ring, and check that the level bubble is within +/-10 minutes from the center. Each division equals 2 minutes.

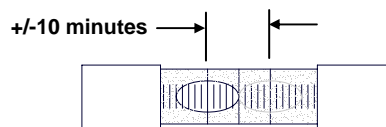

- 2 If the level bubble not is within this limit, add or remove weights from the horizontal ring until it is level.

Note!

It is important that the total number of weights on the horizontal ring is as few as possible.

- 3 Let the compass run for at least 20 minutes before the level is rechecked and eventually confirmed.

WARNING

If the horizontal ring is tilted more than +/- 10', a bearing error may be generated!

4.8 Replacing the Fuses

WARNING

Before a fuse is replaced, disconnect the respective power for the damaged fuse.

Use the procedures described in the following pages when replacing the fuses.

Master Compass

Fuse F1 is located inside the fuse holder in the front of the Master compass.

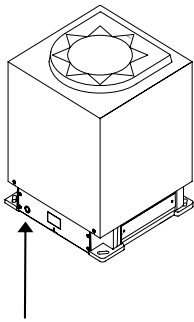

F1 (12A)

1. Open the fuse holder by pressing and turning the fuse holder edge counter-clockwise with a screw driver.
2. Replace fuse F1, and close the holder by turning it clockwise.

Compact Control unit

For location of the fuses, refer to the drawing on next page.

FUSE NO	CAPACITY	TB-NO	SIGNAL	DESCRIPTION
F1	1A	TB1-33	1R24+	Power supply for ch.1 serial repeater
F2		TB1-38	2R24+	Power supply for ch.2 serial repeater
F3		TB1-43	3R24+	Power supply for ch.3 serial repeater
F4		TB1-48	4R24+	Power supply for ch.4 serial repeater
F5		TB1-21	ST15	Power supply for ch.1 step motor repeater
F6	10A	TB3-1	24M+	Main power supply (standard type) Master compass power supply (with Power supply unit)
F7	3.15A	TB3-3	24B+	Power supply for ICIF and IOPT board (with Power supply unit)
F8	6.3A	TB2-1	24R+	Power supply for repeaters (with Power supply unit)
F9	10A	TB3-5	24BT+	Emergency power supply (standard type)

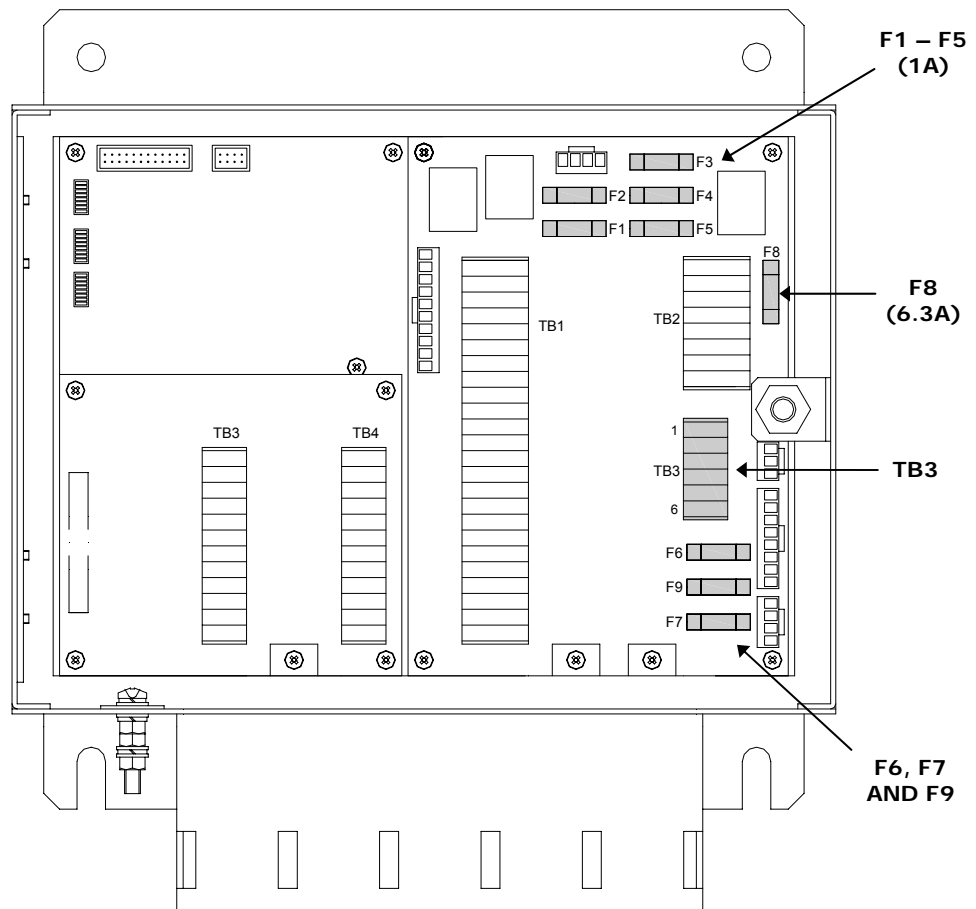

WARNING

Make sure that power is disconnected from pin 1-4 on TB3 before any fuse is replaced!

Note!

The fuses in the Compact Control unit are open glass type and may be damaged if handles with force.

- 1** Pull the damaged fuse up from the holder.
- 2** Re-install a new fuse by carefully pushing it into the holder. When correctly located, it should be fixed 1-2mm above and parallel with the mounting level.

Power Supply Unit (Option)

FUSE NO	CAPACITY	TB-NO	SIGNAL	DESCRIPTION
F201	6.3A	TB201	2AC1/2	Main power supply
F202	20A	TB201	2B+/-	Emergency power supply

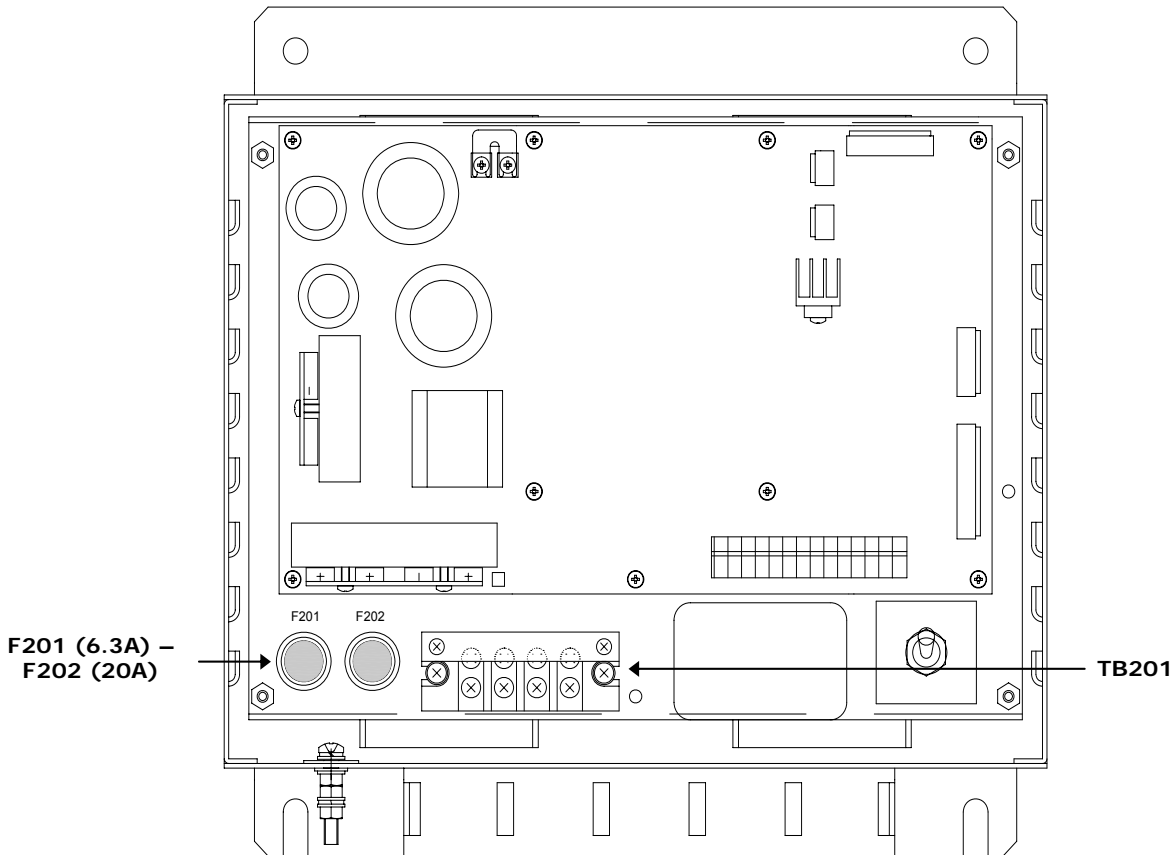

Caution

Make sure that power is disconnected from TB201 before any fuses are replaced.

The fuses in the Power Supply unit are located inside a fuse holder.

- 1 Open the fuse holder by pressing and turning the fuse holder edge counter-clockwise with a screw driver.
- 2 Replace fuse F201 and F202, and close the holder by turning it clockwise.

5 INSTALLATION

This section is a reference guide for correctly installing and configuring the GC80/85 Gyro Compasses.

5.1 Unpacking and handling

A GC80/85 Gyro compass consists of the following units:

- Master compass
- Sensitive element
- Control unit
- Power Supply unit (Option)
- Spare part kit
- Documentation

The sensitive element is shipped from the factory packed separately in a carton box to protect it from excessive shock and vibration. The final assembly of the sensitive element into the Master compass have to be done when the Master compass is mounted onboard the vessel. Refer page 44.

Note!

It is strongly recommended to keep the packing material for the Sensitive element. This original packing should be used if the element is sent to the factory for overhaul or repair.

Care should be taken when unpacking and handling the equipment. A visual inspection should be made to see that the equipment has not been damaged during shipment and that all components and parts are included.

5.2 Mechanical installation

The units included in the GC80/GC85 system should be mounted with special regard to the units' environmental protection, temperature range and cable length. Refer Technical specifications, page 65 onwards.

Note!

A special tool (part no. 44174449) is required when installing the Sensitive element. This tool is included in the gyro package, and the sensitive element should not be installed without using this tool.

Control unit

The Control unit is bulkhead mounted by using 4 bolts as shown in the illustration.

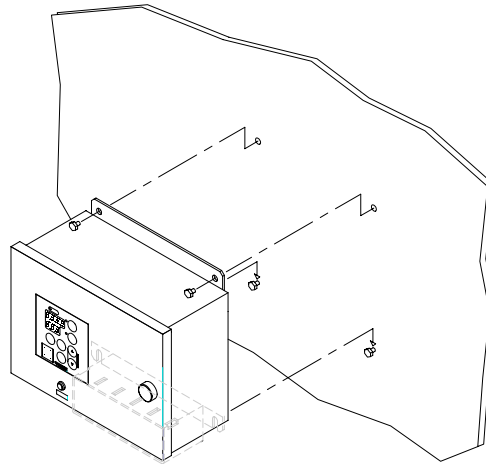

Flush mounting the control panel

The control panel may be removed from the Control unit and mounted in a remote location by using the optional flush mounting kit (part number 27101757).

The flush mounting kit includes:

- 1 flush mounting panel
- 4 corners
- 4 mounting screws
- 1 blind cover

In addition to this kit, an optional control panel cable must be ordered. The cable is available in three different lengths:

- 5m (part no. 44170736)
- 10m (part no. 44170744)
- 15m (part no. 44170751).

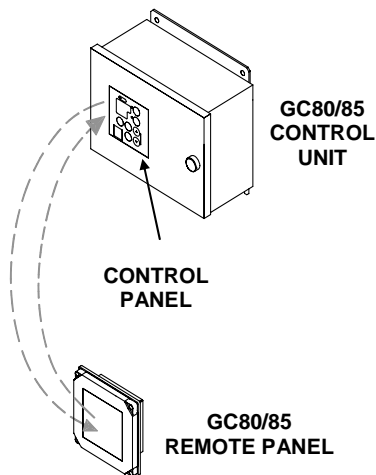

Use the following procedure when mounting the remote control panel:

- 1** Open the control unit, and remove the wiring strips holding the control panel's cable.
- 2** Disconnect the cable's grounding wires (labelled FG) from the control panel and from the PWB_ICIF board in the Control unit.
- 3** Disconnect the plugs and remove the control panel's cable.

- 4** Loosen the 4 nuts holding the control panel, and remove the panel. These nuts are to be re-used when fastening the control panel to the flush mounting panel.
- 5** Insert the control panel in the flush-mounting kit from the front side as shown on the figure. Fasten the panel with the 4 nuts.

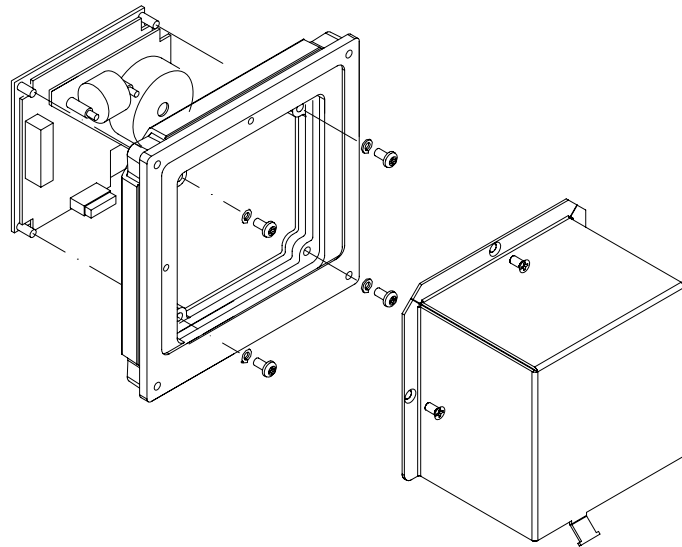

- 6** Insert the plug on the optional control panel cable, and connect the grounding wire.
- 7** Mount the cover on the back side.
- 8** Fasten the cable to the cover by a wire strip.
- 9** Slide the control panel cable through the cable inlet, insert the plug in PWB_ICIF board and connect the grounding wire. Secure the cable to the control unit by a wire strip.
- 10** Insert the blind cover in the Control unit by using the 4 bolts included in the kit.

Power supply unit (Option)

Refer mounting description for the Control unit above.

Dimensional drawings for the optional Power supply unit are found on page 75.

Jumper settings in Compact Control unit

When the optional Power supply unit is included in the GC80/85 compact gyro system, jumper settings in the GC80/85 Control unit have to be modified as follows:

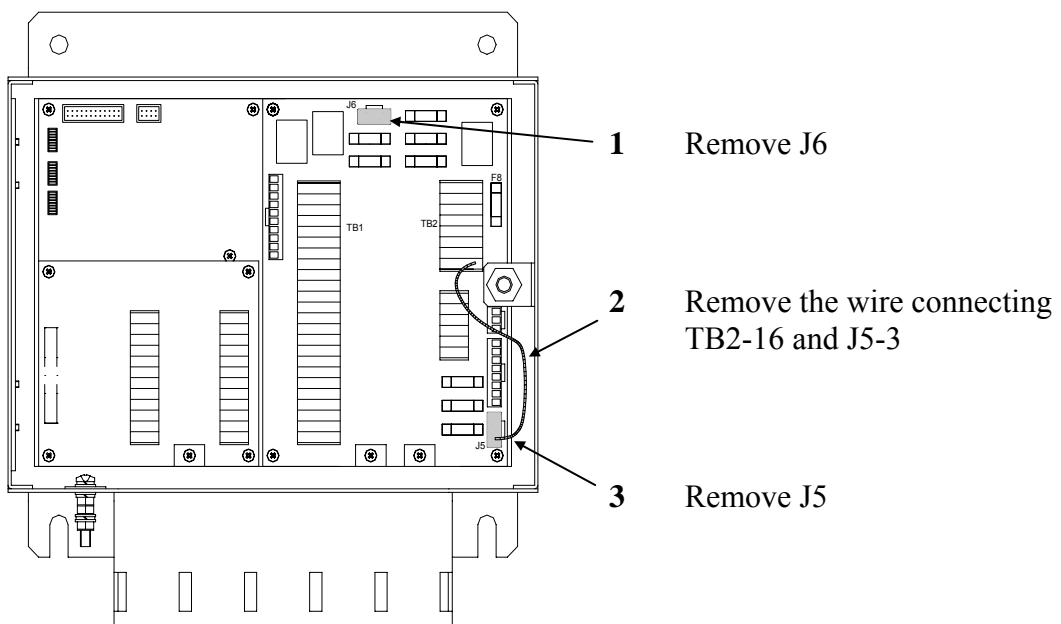

Master compass

Select a mounting location where the deck is horizontally, flat and with little vibration, and where the pitch/roll motion is as small as possible.

It is also important to select a mounting location with sufficient space for installation and service. Refer dimensional drawing, page 74.

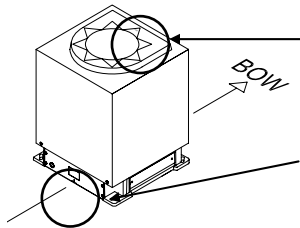

- 1 Locate the compass on or parallel to the vessel's horizontal centerline, with the bow indication on the top of the case pointing towards the vessel's bow.

Use the datum line in the front and back to of the compass to line up the unit.

- It is possible to compensate for a small mounting offset by using the heading offset feature as described in *Adjusting True heading*, page 54.

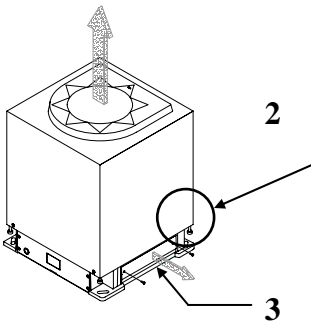

- 2 Remove the four screws holding the compass case, and lift the case carefully upwards and away.

- 3 Remove the cable inlet cover.

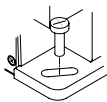

- 4 Fasten the compass to the deck with four bolts. The bolts should be located in the center of the trails for later to be able to adjust the compass direction when the heading is tuned in. Refer *Adjusting True heading*, page 54.

- 5 Remove strips and foam rubber from the chock absorbers, together with all strips used for securing moving parts during transportation.

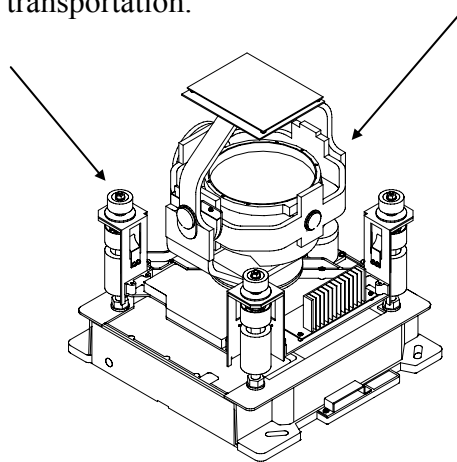

Note!

The foam rubber should be kept for re-use if the Master compass has to be sent to factory for service!

5.3 Cabling

Note!

No cables are included when the gyro system is delivered from factory.

The wiring diagram on page 72 onwards includes cable specification for all cables that have to be used.

Caution

If the optional Power Supply unit is included in the system, jumper settings have to be modified as described in page 39.

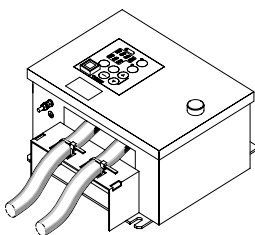

Connect power and signal cables according to the wiring diagram on page 72 onwards.

To avoid that vibration should cause the cables to loose connection, the cables could be fastened to the fixing device by using wire straps as illustrated on the figure.

5.4 Grounding the units

All units in the GC80/GC85 system should have a proper ground connection from the unit's ground terminal.

The wires should be as short as possible and have a cross section of at least AWG13 (2.5mm²).

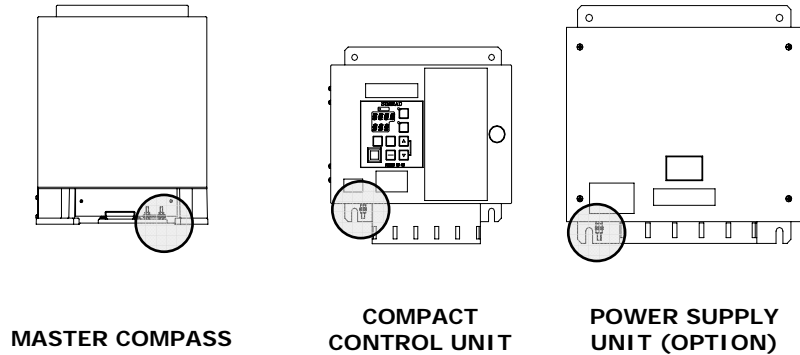

5.5 Dip-switch and jumper settings

GC80 and GC85 gyro systems include several dip switches and jumpers. With the exception of two switches on the ICIF board in the Control unit, no switches have to be set when installing the system. These two switches are set to configure the Control unit to match type of gyro system (GC80 or GC85), and to activate an external heading sensor.

Note!

These dip switch settings are read when the system is started. Any changes when the system is running will therefore not take affect before the system is restarted.

For a complete list of dip switch settings, refer to ***DIP SWITCH SETTINGS***, page 89.

Activating the control unit for GC80 or GC85 system

When the gyro system is shipped from factory, all dip switches in the Control unit are set as for a standard GC80 system.

Before the system is started, the switch settings described below have to be changed to match a GC85 system.

Dip switch no.2 on S1 on the ICIF board identifies the gyro as a GC80 or GC85 system.

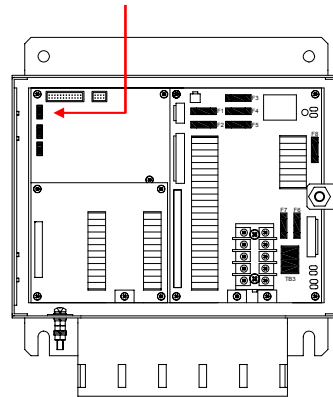

GC80 system	GC85 system
<p>OFF</p> <p>1</p> <p>S1</p> <p>8</p>	<p>1</p> <p>ON</p> <p>S1</p> <p>8</p>

All outputs are selectable for 1, 5, 10 or 50Hz.

Refer dip switch settings on page 91 and jumper settings on page 93.

Note!

A GC85 system is recommended to be set for 50Hz output!

Activating an external heading sensor

If an external heading sensor is connected to the GC80/GC85, dip switch no.5 on S1 on the ICIF board has to be set to enable the external heading sensor.

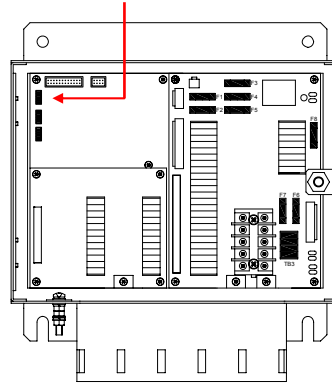

No external sensor	Active external sensor
<p>1 8 OFF S1</p>	<p>1 8 ON S1</p>

Activating the pendulum function

If an external switch is connected to GC80/85 to operate the pendulum function, dip switch no.4 on S2 on the ICIF board has to be set to activate the pendulum function.

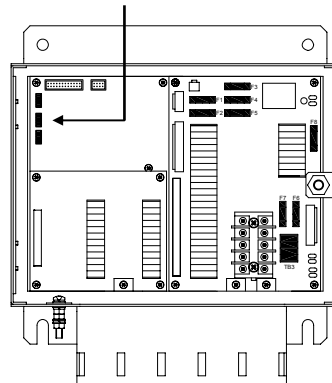

Pendulum function disabled	Pendulum switch enabled
<p>1 8 OFF S2</p>	<p>1 8 ON S2</p>

5.6 Installing the Sensitive element

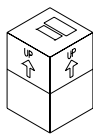

The Sensitive element is shipped from the factory packed separately, and the element has to be installed in the Master compass according to the description below.

Note!

A special tool (part no. 44174449) is required when installing the Sensitive element. This tool is included in the gyro package, and the sensitive element should not be installed without using this tool.

Caution

Use extreme caution when handling the Sensitive element! Do not tilt the element. It is filled with oil and the top includes a ventilation opening.

- 1 Make sure that the master compass is installed and cables connect according to the description on page 40 onwards.

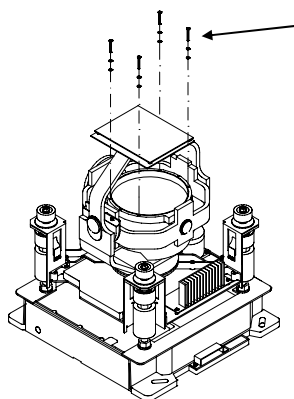

- 2 Remove the four screws on the Horizontal ring.
- 3 Lift the sensitive element carefully from its package, and remove the rubber tube on top of the element.

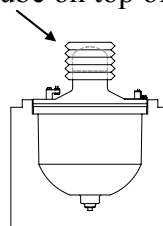

Note!

The package and the rubber tube should be kept for re-use if the Sensitive element has to be sent to factory for service!

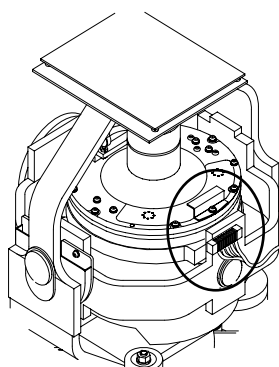

- 4 Tilt the Horizontal ring to the side where the plug is located, and carefully put the sensitive element into the ring.
 - The socket on the Sensitive element should be located right above the plug attached to the Horizontal ring.

- 5** Position the Sensitive element on the Horizontal ring by putting the assembly jigs into the holes as indicated on the figure below. Observe the labelling and the diameter on the jigs. Fasten two screws in the other two holes.

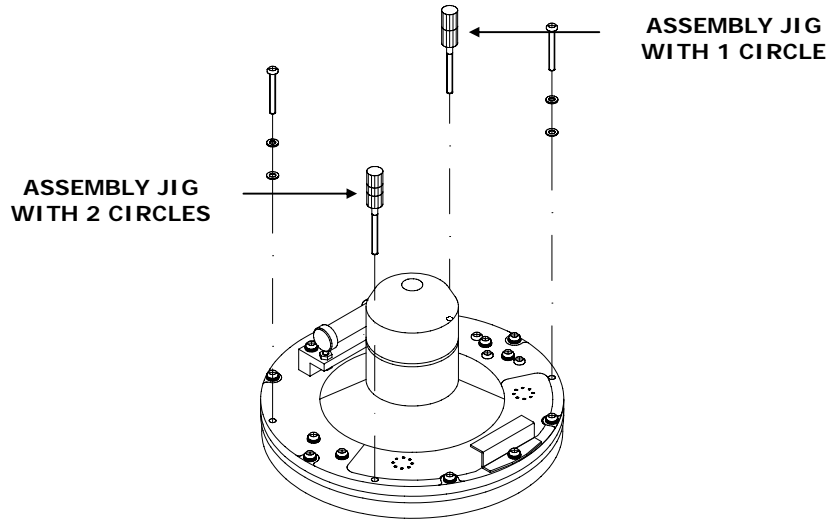

- 6** Replace the assembly jigs with the two remaining screws. Locate the ground wire on one of the screws as shown on the figure.

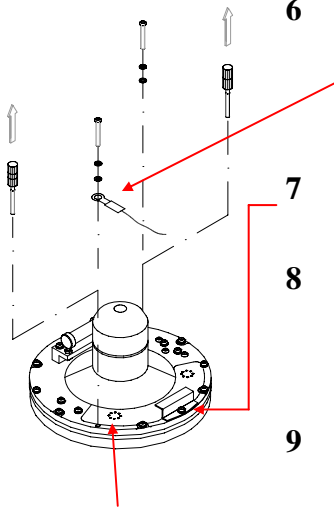

Ground wire connection

- 7** Loosen the screw on the plug holder on the Sensitive element, and lift the holder 2-3 mm upwards.
- 8** Connect the plug to the connectors on the Sensitive element's pcb according to the labelling on the pcb and on the wires. Make sure that the pin guides on the plug are properly entered, and that the wires not are twisted.
- 9** Firmly tighten the screw on the holder.

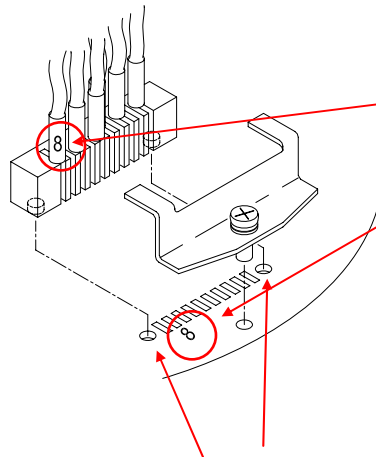

Pin guides

Verifying the element's tilt angle

- 1 Tilt the Sensitive element by hand towards the level tool on the Horizontal ring and keep it tilted for approximately 1 minute. Remove the pressure and observe that the tilt angle remains at:
 - GC80: 15° to 19°
 - GC85: 18° to 22°

The tilt angle is indicated on the figures below.

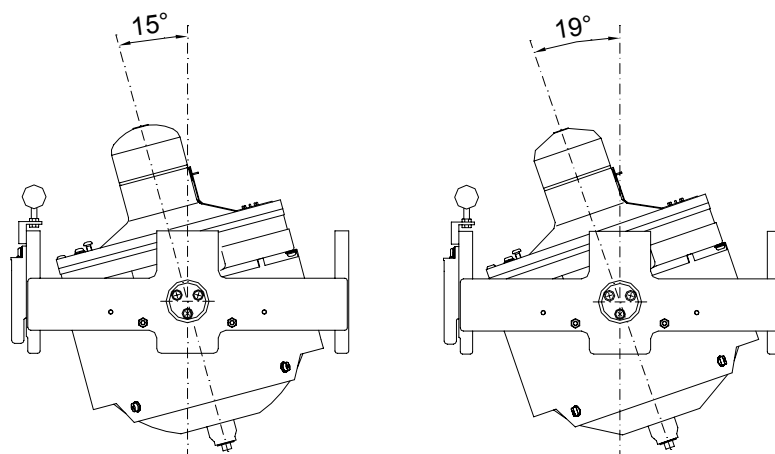

Max and min tilt angle for GC80 std system

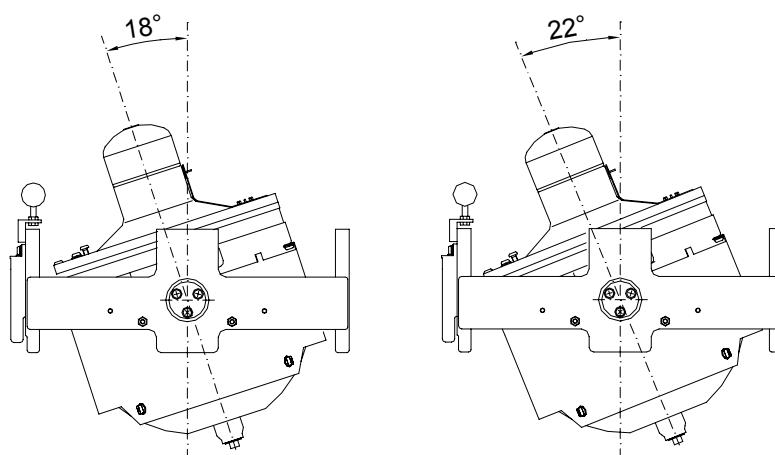

Max and min tilt angle for GC85 High Speed system

Note!

The tilt angle shown above is correct for cold condition. The angle may change when the element has reached normal operational temperature!

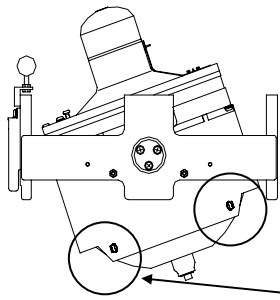

- 2 If the tilt angle is incorrect, weight disks must be adjusted by moving weights from one side to the other. After adjustments, wait for 2 minutes for the oil to set before the tilt angle verification is repeated.

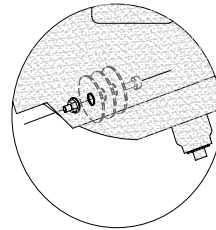

Caution

The sensitive element must have equal number of weight disks on both weight points on the tilting side (north and south side)!

- 3 Carefully rotate the Horizontal ring at least one complete rotation. Verify that all movable parts will turn around without making any contact with mechanical or electrical components.

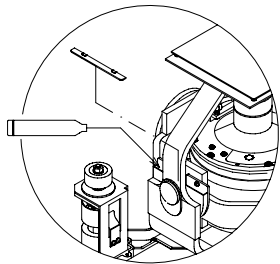

- 4 Lift the lid from the damper oil case, and fill the container with the supplied damper oil. The oil has high viscosity, and care should be taken when pouring the damper oil into the container to avoid spill. Reinstall the lid on the damper oil case.

Any oil spilled on the outside should be cleaned.

5.7 System start-up and software configuration

When all GC80 units are installed and the cables connected according to the procedures described in previous chapters, the system is ready for the first time start-up procedure.

System Start-up



Turn ON the gyro system by pressing the **POWER** button on the Control panel. The following start-up sequence will take place:

- Control unit type (GC80 Std, or GC85 HSc), SW version for Control unit and for Master compass is displayed in rapid succession. Examples of display text are shown below:

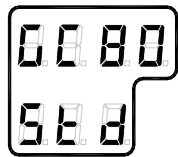

GC80 CONTROL UNIT
STD VERSION

OR

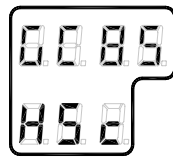

GC80 CONTROL UNIT
HIGH SPEED
VERSION

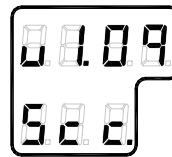

SW VERSION
CONTROL UNIT

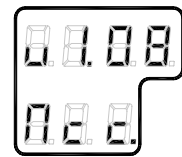

SW. VERSION
MASTER COMPASS

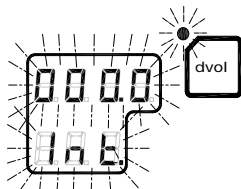

- The sensitive element starts rising horizontally, and the compass turns 360° clockwise. The display shows decreasing bearing as the compass is turning.

- If the gyro has been turned ON and OFF again, but rotor still rotating when the **POWER** button was pressed for new start, a rotor break function will be activated to completely stop the rotor.

- Active rotor break is indicated with flashing display.

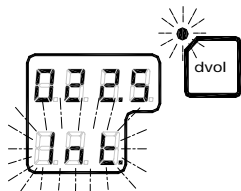

- When the rotor rotation is stopped, start bearing is indicated with flashing text in the display. The start bearing will be the same as active bearing when the compass was turned OFF.

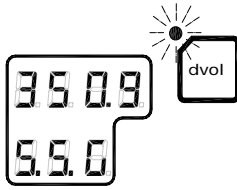

- 6 The indicated start bearing is accepted by pressing the **ACK/ENT** button, or increased/decreased by using the arrow buttons and then pressing the **ACK/ENT** button. If no action is taken within 3 minutes, the start-up process will continue with the indicated start bearing. The bearing indication stops flashing when the start bearing is accepted, while the lamp remains flashing. The rotor starts spinning, and reaches full speed after maximum 30 minutes.

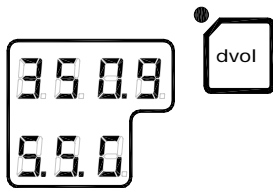

- 7 When the rotor has reached full speed, the compass starts the north seeking function. The display will now change to show the compass' actual heading, and from now on bearing output will be available. The lamp next to the **GYRO** button changes from flashing to steady light.

The GC80/GC85 will be settled within 3 hours when started with a deviation angle less than 5°. With a larger deviation angle, the compass will be settled within 4 hours.

Configuring the gyro system

Each Sensitive element is tuned to its Master compass before it is shipped from the factory. This tuning is reflected in a set of parameters specific for this gyro compass. These parameters are included in the sensitive element's package, and they have to be entered into the Control unit as part of the gyro compass' installation procedure.

Parameters used for time settings should also be entered. These parameters are essential when monitoring the occurrence of alarms.

The parameters are loaded into the Control unit from the Extension menu as described below.

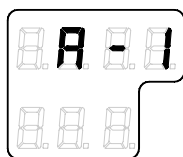

- 1 Enter the Extension menu by pressing and holding the **SET** button and the **ACK/ENT** buttons simultaneously for appr. 3 seconds.

Main category **A-1** will be displayed.

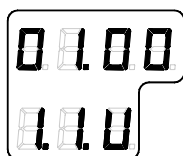

- 2 Press the **SET** button to enter the sub-category loop. Sub-category **1.1.U** and its parameter values will be displayed.

- 3 Use the arrow buttons to increase or decrease the parameter value until the value is according to value in the table included with the sensitive element.

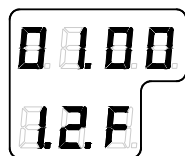

- 4 Confirm the entry by pressing the **ACK/ENT** button. The display will return to sub-category **1.1.U**, and the data will be transferred to the gyro immediately.
- 5 Press the **DISP** button again to select sub-category **1.2.F**, and use the arrow buttons to increase or decrease the parameter value until the value corresponds with the parameter for the new sensitive element. Confirm the entry by pressing the **ACK/ENT** button.
- 6 Repeat step 5 for sub-category **1.3.S**, **1.4.u**, **1.5.L** and **1.6.t**.

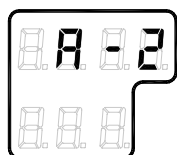

- 7 Press the **SET** button again to return to main category **A1**, and then press the **DISP** button to go to **A2** main category.
- 8 Press the **SET** button, and enter values for **2.1.o** and **2.3.h** as described above.
- 9 While still in **A2** main category, enter values for **2.5.y** (Year), **2.6.N** (Month and Day), **2.7.t** (Hour and Minute) and **2.8.d** (total days of operation. This value should be reset after installation).

Note!

All time parameters should preferably be in CET (Central European Time) or eventually in local time.

- 10 Exit the sub-category by pressing the **SET** button, and then exit the Extension main category by pressing and holding the **SET** and **ACK/ENT** buttons simultaneously for appr. 3 seconds.

For more information about the Extension menu, see **ADVANCED SETTINGS**, page 57 onwards.

Setting the Latitude input source

When the system is configured as described in *Configuring the gyro system* page 50 onwards, the latitude input source can be changed as described below.

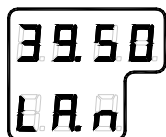

- 1 Press the **DISP** button until the display shows latitude value.

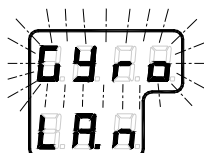

- 2 Press **SET** button once, and the upper line in the display starts flashing.

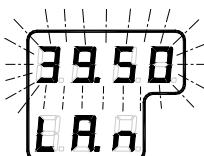

- 3 Use the arrow buttons for selecting **Gyro** or **GPS** as the latitude input source, and confirm the entry with the **ACK/ENT** button.

- If **Gyro** is selected, the display will change to flashing numbers
- If **GPS** is selected, the display will show the latitude value read from the GPS

- 4 When **Gyro** is selected and the numbers are flashing, press the arrow buttons for increasing/decreasing the latitude value, and confirm the entry with the **ACK/ENT** button.

- This entered latitude value will now be used, together with speed and bearing information, for calculating the vessel's current latitude.

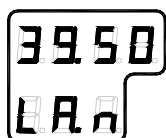

- 5 The display will return to show latitude value without flashing.

Setting the Speed input source

When the system is configured as described in *Configuring the gyro system* page 50 onwards, the speed input source can be changed as described below.

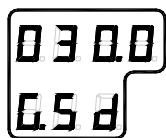

- 1 Press the **DISP** button until the display shows speed value and speed input source.

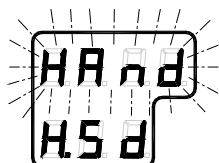

- 2 Press **SET** button once, and the upper line in the display starts flashing.

- 3 Use the arrow buttons for toggling between available speed input sources:

Manual

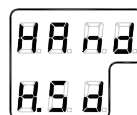

GPS

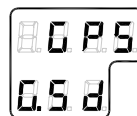

LOG (pulse)

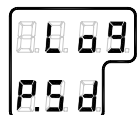

LOG (serial)

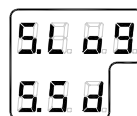

- 4 Select active speed input source, and confirm the selection by pressing the **ACK/ENT** button.

- 5 If Manual input source is selected, the display will change to show flashing numerical values.



- 6 Use the arrow buttons for entering the speed value, and confirm the input by the **ACK/ENT** button.



- 7 The display will return to shown speed value and speed input source without flashing.

5.8 Balancing the Horizontal ring

After the compass has been running continuously for at least 2 hours, the horizontal ring should be adjusted.

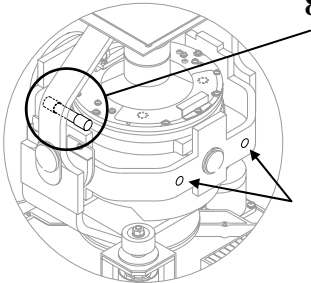

- 8** Locate the reference level tool on the horizontal ring, and check that the level bubble is within ± 10 minutes from the center. Each division equals 2 minutes.

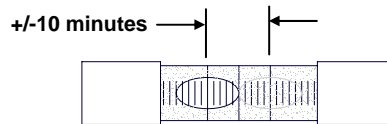

- 9** If the level bubble not is within this limit, add or remove weights from the horizontal ring until it is leveled.

Note!

It is important that the total number of weights on the horizontal ring is as few as possible.

- 10** Let the compass run for at least 20 minutes before the level is rechecked and eventually confirmed.

Caution

If the horizontal ring is tilted more than $\pm 10'$, a bearing error will be generated.

Adjusting True heading

After the GC80/85 is settled, the gyrocompass has to be calibrated against an external reference, e.g.:

- a known target
- astronomical observation
- the heading of the pier or quay the vessel is moored to
- two fixed points on the chart that the vessel is sailing between

The observation period for the heading difference should be as long as possible.

If there is any difference between the gyro bearing and the confirmed external reference that not can be corrected by adjusting the mechanical location of the master compass, an offset value may be inserted in the GC80. This value is entered by using the Extension menu as follows:

- 1** Activate the Extension menu by pressing and holding the **SET** button and the **ACK/ENT** buttons simultaneously for at least 3 seconds.
- Main category **A-1** will be displayed.

- 2 Press the **DISP** button once to display main category **A-2**.
- 3 Press the **SET** button to enter the sub-category **2.1.o**.
- 4 Use the arrow buttons to increase or decrease the offset parameter value.

Note!

To correct for $+1.5^\circ$, press the Arrow Up button until the display shows 1.5° .

To correct for -1.5° , press the Arrow Down button until the display shows 358.5° !

- 5 Confirm the new value by pressing the **ACK/ENT** button, or reject the changes by pressing the **SET** button. The display will return to sub-category **2.1.o**.
- 6 Exit the Extension menu by pressing and holding the **SET** and **ACK/ENT** buttons simultaneously for at least 3 seconds.

For further information about the Extension menu, refer *Using the Extension menu*, page 58 onwards.

**THIS PAGE INTENTIONALLY LEFT
BLANK**

6 ADVANCED SETTINGS

This section gives an overview of the Extension menu, how to enter the menu and how to change parameter values.

6.1 General

The Extension menu holds internal parameters and communication parameters required to achieve the best possible heading accuracy on the GC80/GC85 Gyro compass.

The Extension menu is grouped in 8 main categories, named A-1 through A-8. Each of these main categories has again several sub-categories where parameter values may be set.

All values in the Extension menu are stored in the nonvolatile memory of the compass.

6.2 Using the Extension menu

Caution

The Extension menu should not be entered by unauthorized personnel. Incorrect parameters may result in irregular operation of the GC80/GC85 gyro compass!

The extension menu can be entered when any display is shown in the LCD.

- 1** Activate the menu by pressing and holding the **SET** button and the **ACK/ENT** buttons simultaneously for at least 3 seconds.
 - Main category **A-1** will be displayed.
- 2** Page through the main categories to the selected category by pressing the **DISP** button. Pressing the **DISP** and **ACK/ENT** buttons simultaneously will display the main category loop in reversed order.
- 3** Press the **SET** button to enter the sub-category loop, and use the **DISP** button to select sub-category that holds the parameter to be changed.
- 4** Use the arrow buttons to increase or decrease the parameter value.
- 5** Confirm the new value by pressing the **ACK/ENT** button, or reject the changes by pressing the **SET** button. The display will return to selected sub-category.
- 6** Exit the Extension menu by pressing and holding the **SET** and **ACK/ENT** buttons simultaneously for at least 3 seconds.

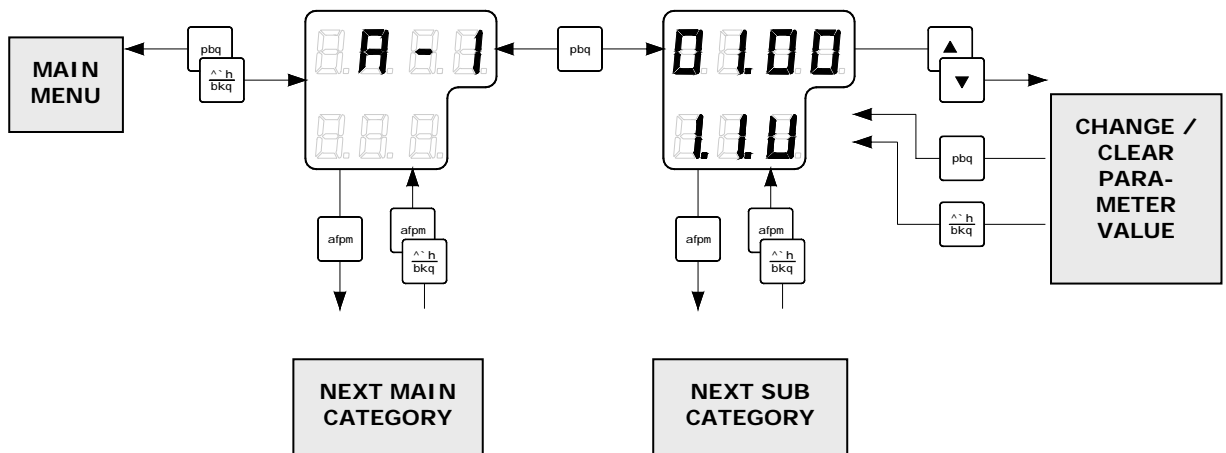

6.3 The Extension menu overview

Main Category	Sub Category	Parameter/description	Default value	Range
A-1	1.1.U	Damping gain Determines the damping (damping operation in north-seeking motion = half cycle attenuation) and actually represents a coefficient (ratio) to the standard value stored in the software.	1.00	0.00 – 2.00
	1.2.F	Bearing servo gain Determines the gain of the bearing servo loop where phi Φ signal (deviation signal around rotor's vertical axis) is calculated, drives the azimuth step motor and has the sensitive element follow to the gyro-sphere vertical axis (around azimuth axis) rotation. Presents a coefficient (ratio) to the standard value stored in software.	1.00	0.00 – 2.00
	1.3.S	Horizontal servo gain Determines the gain of the horizontal servo loop where theta θ signal (rotor tilting angle signal) is calculated, drives the horizontal DST and has the sensitive element follow to the gyro sphere tilting angle (rotor tilting angle). Present a coefficient (ration) to the standard value stored in software.	1.00	0.00 – 2.00
	1.4.u	Leveling servo gain Leveling motion (sensitive element erection motion) calculates X signal (equivalent inclination angle) which is output from the sensitive element and relative inclination angle signal from HRZC board, controls to have the sensitive element keep horizontal. The value determines this control loop gain. Presents a coefficient (ratio) to the standard value stored in the software.	1.00	0.00 – 2.00

Main Category	Sub Category	Parameter/description	Default value	Range
A-1 cont.	1.5.L	(ϕ) Phi offset (°) Offset value (°) around the vertical axis of gyro sphere (rotor axis) and the sensitive element.	0.00	-3.00 – 3.00
	1.6.t	(θ) Theta offset (°) Offset value (°) around the horizontal axis of gyro sphere (rotor axis) and the sensitive element.	0.00	-3.00 – 3.00
	1.7.G	X signal pickup gain (v/°) Distance of the sensitive element share and the rotor axis direction. Inclination angle around horizontal axis is obtained equivalently by monitoring this signal. For example, when north side of the rotor axis rises, the sensitive element follows to rise its north side, then gyro sphere suspended by the suspension wire moves to south side. X signal represents this amount of movement (v/°). This parameter is only used for GC85.	2.32	0.00 – 5.00
	1.8.c	Ks/H Suspension wire twist torque. Fixed value.	1.477	1.000 – 2.000
	1.9.r	Maximum rate of turn (°/sec) Maximum rate of turn in the turn rates which the bearing servo system followed up to this moment (°/sec). <u>NOTE:</u> The maximum is measured after 3 hours from system start. <u>NOTE:</u> Reset this data certainly after completion of installation!	0.00	-
	1.A.F	Maximum deviation of bearing servo (°) Maximum deviation value in the bearing servo loop that occurred up to this moment (°). <u>NOTE:</u> The maximum is measured after 3 hours from system start. <u>NOTE:</u> Reset this data certainly after completion of installation!	0.00	-
	1.b.S	Maximum deviation of horizontal servo (°) Maximum deviation value in the horizontal servo loop that occurred up to this moment (°). <u>NOTE:</u> The maximum is measured after 3 hours from system start. <u>NOTE:</u> Reset this data certainly after completion of installation!	0.00	-

ADVANCED SETTINGS

Main Category	Sub Category	Parameter/description	Default value	Range
A-2	2.1.o	<p>Bearing offset A (°)</p> <p>Offset value included in the “master bearing” and used for correction of fixed error (°). If the master compass not can be mounted parallel to the vessel’s fore-aft line, this parameter is used to compensate for a small mounting error.</p>	0.0	0.0 – 359.9
	2.2.O	<p>Bearing offset B (°)</p> <p>Value for general bearing error correction to enter to master compass bearing. It is used to correct the bearing if the bearing for some reason deviates from correct heading.</p> <p>This value is cleared when it passes the zero-cross pin or when power is switched OFF.</p>	0.0	0.0 – 359.9
	2.3.h	<p>Zero-cross bearing (°)</p> <p>Absolute bearing set for MCU board when zero-cross pin was passed during start-up sequence (last azimuth operation) and normal running operation.</p> <p>Zero-cross bearing can be set in this menu, but is normally set up by measuring position (angle) of the zero-cross pin in the master compass by the test mode A.</p>	345.3	0.0 – 359.9
	2.4.E	<p>Zero-cross error allowance (°)</p> <p>Zero-cross alarm limit. The compass will generate a zero cross alarm when the difference between the zero-cross bearing and the relative bearing exceeds this zero cross value.</p> <p>This value should be set every time the zero-cross pin is detected.</p>	2.0	0.0 – 5.0
	2.5.y	<p>Year</p> <p>Used for setting current year.</p>	-	2000 - 2099
	2.6.N	<p>Month and Day</p> <p>Used for setting current month and date.</p>	-	-
	2.7.t	<p>Hour and Minute</p> <p>Used for setting current hour and minute.</p>	-	-
	2.8.d	<p>Total days of operation</p> <p>This value should be reset after the installation is completed.</p>	-	-

Main Category	Sub Category	Parameter/description	Default value	Range
A-2 cont.	2.9.G	Display/setting of GPS connection The following abbreviations are used: bE: GPS connected Non: No GPS connected <i>NOTE: When this value is set to "Non", GPS can not be selected as the vessel's input for speed and latitude.</i>	-	bE or Non
	2.A.L	Display/setting of LOG connection The following abbreviations are used: bE: with Log (contact) Non: No Log (contact) <i>NOTE: When this value is set to "Non", LOG can not be selected as the vessel's speed input.</i>	-	bE or Non
	2.b.S	Display/setting of LOG (serial) connection The following abbreviations are used: bE: with Log (serial) Non: No Log (serial) <i>NOTE: When this value is set to "Non", SLOG can not be selected as the vessel's speed input.</i>	-	bE or Non
	2.c.t	Display/setting of GPS performance index data check The following abbreviations are used: bE: Check performance index Non: Not check performance index	-	bE or Non
	2.d.o	Analogue signal output offset for ROT (°) Offset value for analogue signal output of Rate Of Turn. Entered value is +/-5% of maximum output ROT.	0.00	0.0 – 16 ¹
	2.e.F	Filter time constant for rate of turn (sec)	2.00	0.5 – 10.0
	2.F.G	Analog output gain for rate of turn	1.00	0.90 – 1.00
A-3	3.1.E	Alarm (error)	-	-
	3.2.n	Occurred number of zero-cross error	-	-
	3.3.H	Maximum zero-cross error	-	-
	3.4.y	Occurred year of zero-cross error	-	-
	3.5.N	Occurred month/day of zero-cross error	-	-
	3.6.t	Occurred hour/minute of zero-cross error	-	-
	3.7.n	Occurred number of encoder error	-	-
3.8.r	Occurred number of reset with WATCH DOC TIMER	-	-	

¹ The maximum value is 5% of the maximum analog output for rate of turn.(32 deg./min: 1.6deg./min., 130deg./min: 6.5deg./min., 320deg./min: 16.0deg./min.)

ADVANCED SETTINGS

Main Category	Sub Category	Parameter/description	Default value	Range
A-4	4.1.C	GPS serial data character length	8	8 or 7
	4.2.P	GPS serial data parity bit	Non	Non, Even, Odd
	4.3.S	GPS serial data stop bits	1	1 or 2
A-5	5.1.C	LOG serial data character length	8	8 or 7
	5.2.P	LOG serial data parity bit	Non	Non, Even, Odd
	5.3.S	LOG serial data stop bits	1	1 or 2
A-6	6.1.C	External sensor (standard) serial data character length	8	8 or 7
	6.2.P	External sensor (standard) serial data parity bit	Non	Non, Even, Odd
	6.3.S	External sensor (standard) serial data stop bits	1	1 or 2
A-7	7.1.t	Master compass type	Std	Std or Hsc
	7.2.u	SCC software version number	-	-
	7.3.u	MCC software version number	-	-
A-8	8.1.t	For confirmation of extension menu	-	-
	8.2.S	Filter of speed error correction	On	On or Off

**THIS PAGE INTENTIONALLY LEFT
BLANK**

7 TECHNICAL SPECIFICATION

This section lists all specifications for GC80/85 gyro compass.

7.1 Accuracy

Settling time:	within 3 hours (if startup heading is within +/-5° of actual heading)
Settle point error:	less than ±0.1°
RMS value of the difference:	less than 0.1°
Repeatability of settle point error:	less than ±0.1°
Roll and pitch error:	less than ±0.4°
Static error:	less than ±0.1°
Settle point error under general conditions:	less than ±0.4°

Note!

Accuracy at equator. For other latitudes, accuracy to be multiplied by $(1/\text{COS } f)$, where $f = \text{Latitude}$.*

7.2 General specification

Follow-up speed:	> 75°/sec
Gimbal freedom	for both roll and pitch: ±45°
Range of speed correction:	0-50 knots (GC80) / latitude (0° - +70°) 0-70 knots (GC85) / latitude (0° - +70°)
Main power supply:	24V DC or Option: 100/110/115/200V AC, 50/60Hz
Power supply for alarm and back-up:	24V DC, 70W
Voltage fluctuation:	AC ±10% DC -20% - +30%
Frequency variation:	±5%
Power consumption:	Start: within 140VA Ordinary: within 70VA Repeater: within 17VA
Repeater type:	24V DC – 6 step/°
Number of step repeater connections:	1
Number of NMEA connections:	4
Repeater back-up circuits:	1+4
Pendulum function:	refer page 19

7.3 Input specification

Serial input signal (GPS)

Circuits:..... 1
 Electrical:..... RS422/MNEA0183/Current loop
 Baud rate:..... 4800 bps
 Data bits:..... 8 bits
 Parity:..... None
 Stop bits:..... 1
 Freq.:..... 1 – 5Hz
 Input format:
 \$--GGA, x, xxxx.xx, N, xx.x, E, x, ~*hh<CR><LF>
 \$--GLL, xxxx.xx, N, xxxx.xx, E, *hh<CR><LF>
 \$--VTG, xx, T, xx, M, xx.x, N, xx, K*hh<CR><LF>

Serial input signal (External heading)

Circuits:..... 1
 Electrical:..... RS422/NMEA0183
 Baud rate:..... 4800/38400 bps
 Data bits:..... 8 bits
 Parity:..... None
 Stop bits:..... 1
 Freq.:..... 1 - 50Hz/20 – 50Hz
 Input format:
 \$--HDT, xxx.x*hh<CR><LF>
 \$--HDG, xxx.x*hh<CR><LF>

Serial input signal (LOG)

Circuits:..... 1
 Electrical:..... RS422/NMEA0183
 Baud rate:..... 4800 bps
 Data bits:..... 8 bits
 Parity:..... None
 Stop bits:..... 1
 Transmit freq.:..... 1 - 50Hz
 Input format:
 \$--VBW, x.x, x.x, A, ~*hh<CR><LF>

PULSE signal (LOG)

Circuits:..... 1
 Electrical:..... 200/400 p.p.n.m., dry contact

7.4 Output specification

Serial output signal 1

When Gyro
is selected

Circuits:.....4
 Electrical:.....RS422/485
 Baud rate:
 GC80:.....4800/38400 bps
 GC85.....38400 bps

Note!

*Baud Rate for GC85, refer Jumper settings on ICIF board,
 output serial signal selection, page 93.*

Data bits:.....8 bits
 Parity:.....None
 Stop bits:.....1
 Transmit freq.:
 GC80.....1, 5, 10, 50Hz
 GC85.....1, 5, 10, 50Hz

Output format:

Data no.1

\$ HEHDT, xxx.x, T*hh<CR><LF>

Data no.2

\$ HEROT, -xxx.xx, A*hh<CR><LF>

Data no.3

\$ PCICM, HEALM, xxxx.x, xx*hh<CR><LF>

Serial output signal 2 *1

When
External
heading
sensor is
selected

Circuits:.....4
 Electrical:.....RS422/485
 Baud rate:
 GC80:.....4800 bps
 GC85.....38400 bps
 Data bits:.....8 bits
 Parity:.....None
 Stop bits:.....1
 Transmit freq.:
 GC80.....1, 5, 10, 50Hz
 GC85.....1, 5, 10, 50Hz

Output format:

Data no.1

\$ HEHDT, xxx.x, T*hh<CR><LF>

Data no.2

\$ PTICM, --xxxx.x, xx*hh<CR><LF>

STEP signal	
Circuits:.....	4
Electrical:.....	24V DC – 6 step/°
Alarm output	
Potential free.....	NO/NC
Running contact	
Potential free.....	NO/NC

Refer Jumper settings on ICIF board, page 91.

7.5 Physical Dimensions

GC80 Master Compass

Height:	438 mm (17.2")
Width:	340 mm (13.4")
Depth:	340 mm (13.4")
Weight:	23 kg (51lbs)

GC80 Compact Control Unit

Height:	252 mm (9.9")
Width:	278 mm (10.9")
Depth:	126 mm (5.0")
Weight.....	7 kg (15 lbs)

GC80 Power Supply unit (option)

Height:	290 mm (11.4")
Width:	307 mm (12.1")
Depth:	140 mm (5.5")
Weight.....	8 kg (18 lbs)

7.6 Power

GC80/85 Master Compass

Voltage input:	Supplied from Control unit
----------------------	----------------------------

GC80 Compact Control Unit

Voltage input: 24V DC
Backup voltage: 24V DC
Power consumption, including Master compass:
 Starting:..... 3.3A at 24V DC
 Running:..... 2.6A at 24V DC

GC80 Power Supply unit (option)

Voltage input: 110/220 V AC $\pm 10\%$
Frequency: 50/60 Hz $\pm 5\%$
Backup voltage: 24V DC -20%, +30%

7.7 Environmental Specification

GC80/85 Master Compass

Enclosure material: Aluminum
Color: Black
Temperature range:
 Operating: -10 - 50°C (14 - 122°F)
 Storage: -25 – 70°C (-13 – 158°F)
Angular freedom of gimbal: $\pm 45^\circ$ for roll and pitch

GC80 Compact Control unit

Enclosure material: Aluminum
Environmental protection: IP22
Color: Black
Temperature range:
 Operating: -10 - 50°C (14 - 122°F)
 Storage: -25 – 70°C (-13 – 158°F)
Number of repeater ports: 1

8 DRAWINGS

This section contains outline drawings showing mechanical dimensions of the different GC80/GC85 units, together with wiring diagrams for the gyro system.

8.1 Drawings included

The following mechanical drawings are enclosed:

Name	Drw. no	Rev.
GC80 Compact Control unit, dimensions	N3-710178	A
GC80/85 Master Compass, dimensions	N3-710179	A
GC80/GC85 Power Supply unit, dimensions	N3-710180	A
GC80/85 Remote panel, dimensions	D4-710208	B

To scale drawings are available upon request.

The following wiring diagrams are enclosed:

Name	Drw. no	Rev.
GC80/85 Gyro Compass, Compact system. Wiring diagram	N3-710181	C
GC80/85 Gyro Compass, Compact system with Power supply unit. Wiring diagram	N3-710182	C

Note!

The original signed drawings are recorded at Simrad Egersund.

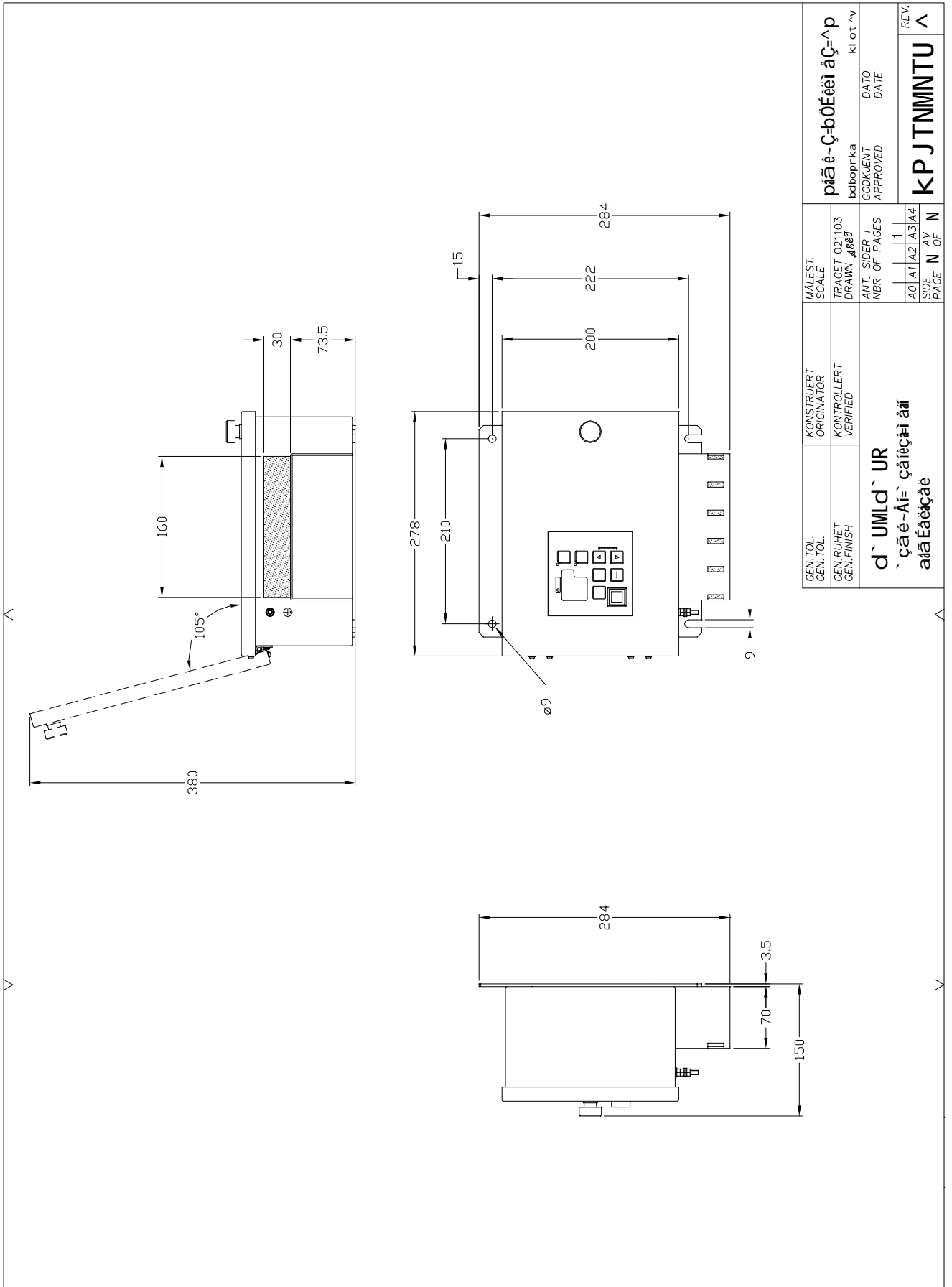

GEN.TOL. GEN.TOL. GEN.FINISH	KONSTRUIERT ORIGINATOR	MALEST. SCALE	piã è-Ç-bòÈèi aç-^p kl ot ^p	
d` UMLd` UR , çã è-Ái= çã èçã èi áã iã ãã Èã èçã è	KONTROLLERT VERIFIED	TRACET 021103 DRAWN 4889	bdtoprka	
		ANT. SIDER J NBR OF PAGES	GODKJENT APPROVED	
		A0 A1 A2 A3 A4	DATE	
		SIDE N OF	DATE	
		PAGE N OF	DATE	
			REV.	
			KPJTMMNTU ^	

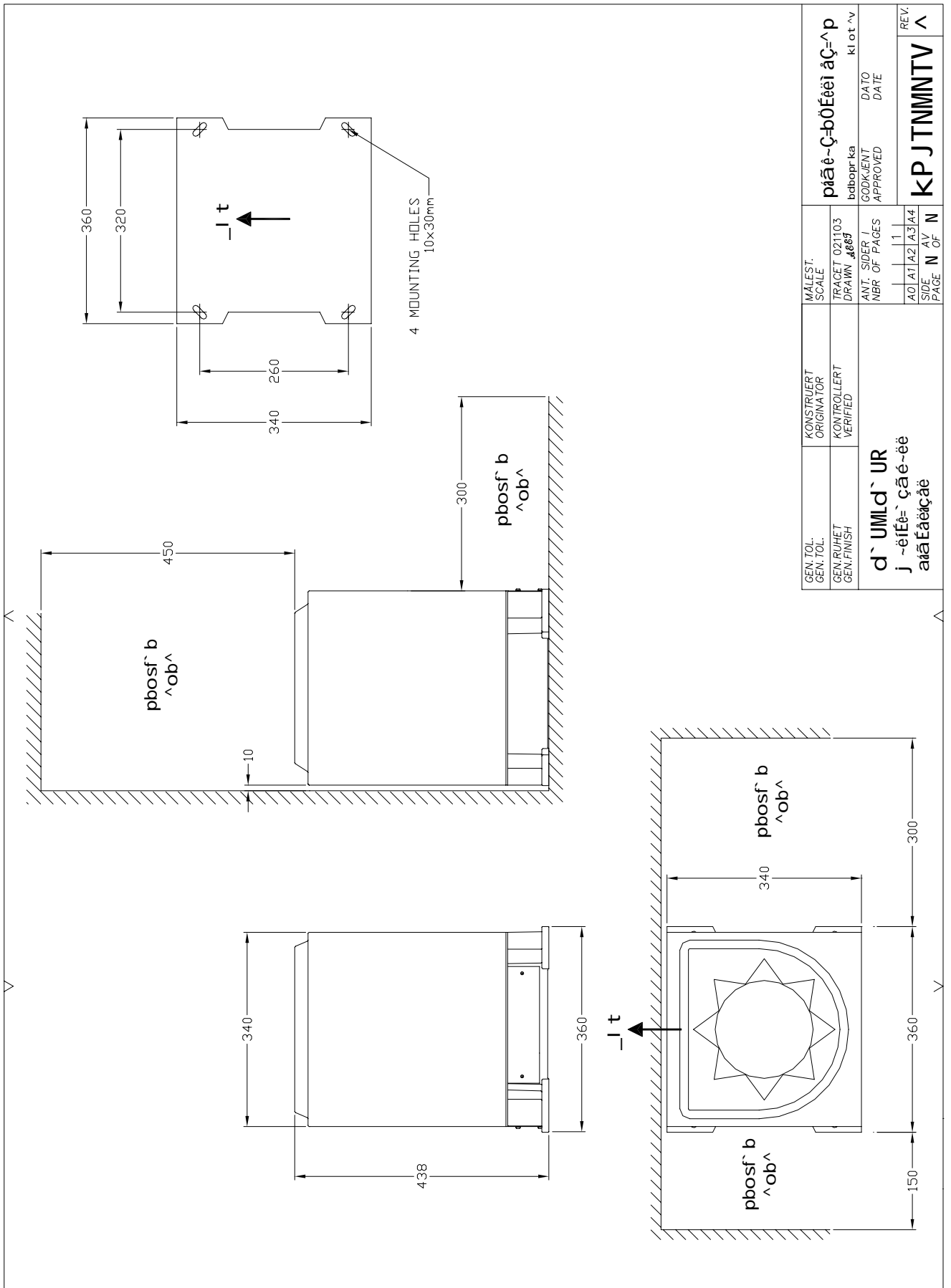

GEN. TOL. GEN. TOL. GEN. FINISH	KONSTRUIERT ORIGINALTOR KONTROLLERT VERIFIED	MALEST. SCALE TRACET 021103 DRAWN 4869	piãê-Ç-bôÉéèi aç-^ p bdboopr ka kl ot ^v
d` UMLd` UR J -ëîÉè- Çãé-èè aiãÉäèçäè	ANT. SIDER J GODKJENT APPROVED	DATE	DATO DATE
		1 1	
		A0 A1 A2 A3 A4 SIDE N OF PAGE N OF	REV. KPJTMMNTV ^

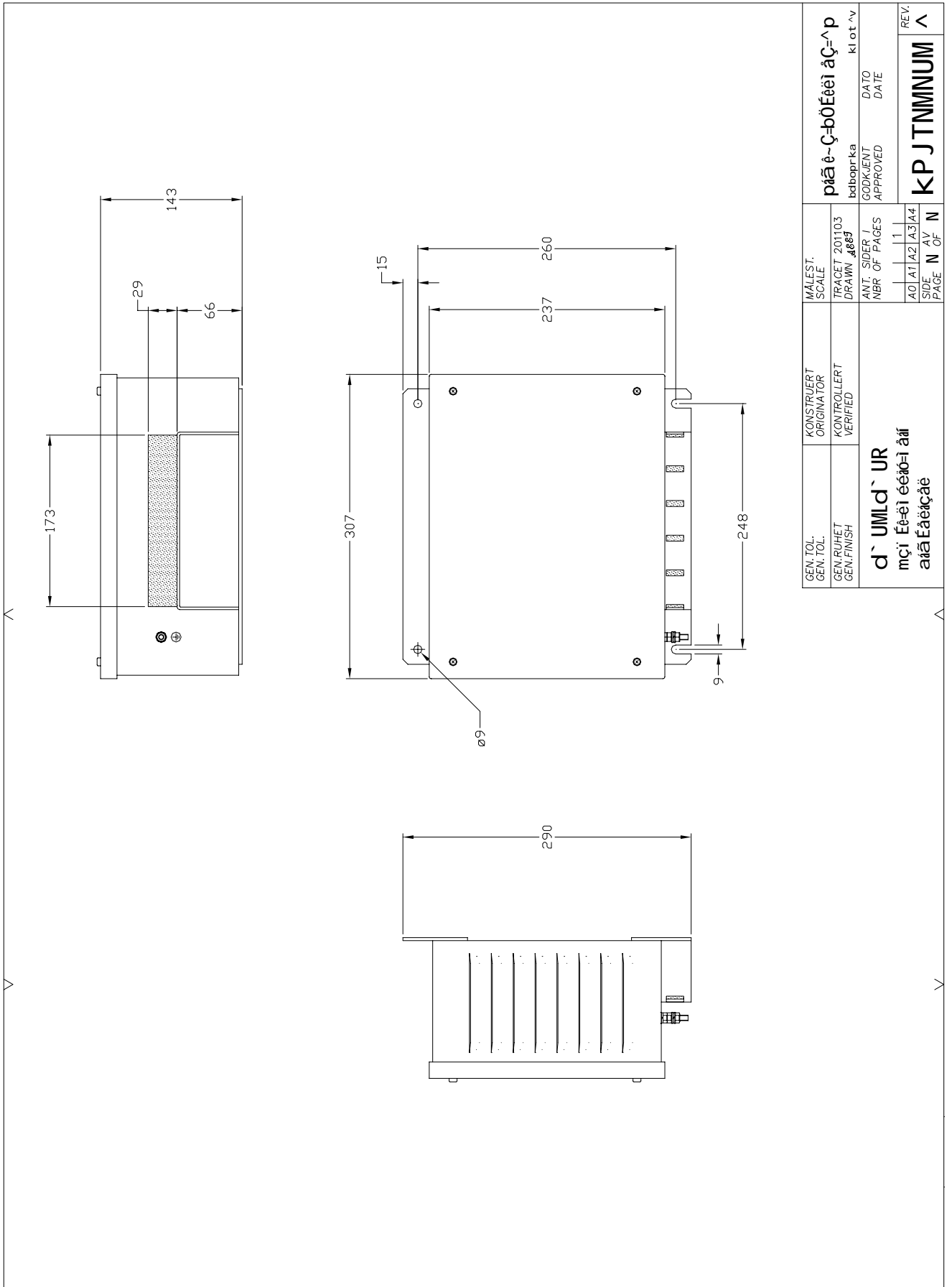

GEN.TOL. GEN.TOL. GEN.FINISH	KONSTRUIERT ORIGINATOR KONTROLLERT VERIFIED	MALEST. SCALE TRACET, 201103 DRAWN, 4889	piã è~Ç-bòÉèèi àÇ-^ p kl ot ^v
d` UMLd` UR mçì Èè-èi ééàò-i àif aiãÉäéçäè	ANT. SIDER J NBR OF PAGES	1 1 A0 A1 A2 A3 A4	bdtoprka GODKJENT APPROVED DATE
			REV. K P J T M N N U M ^

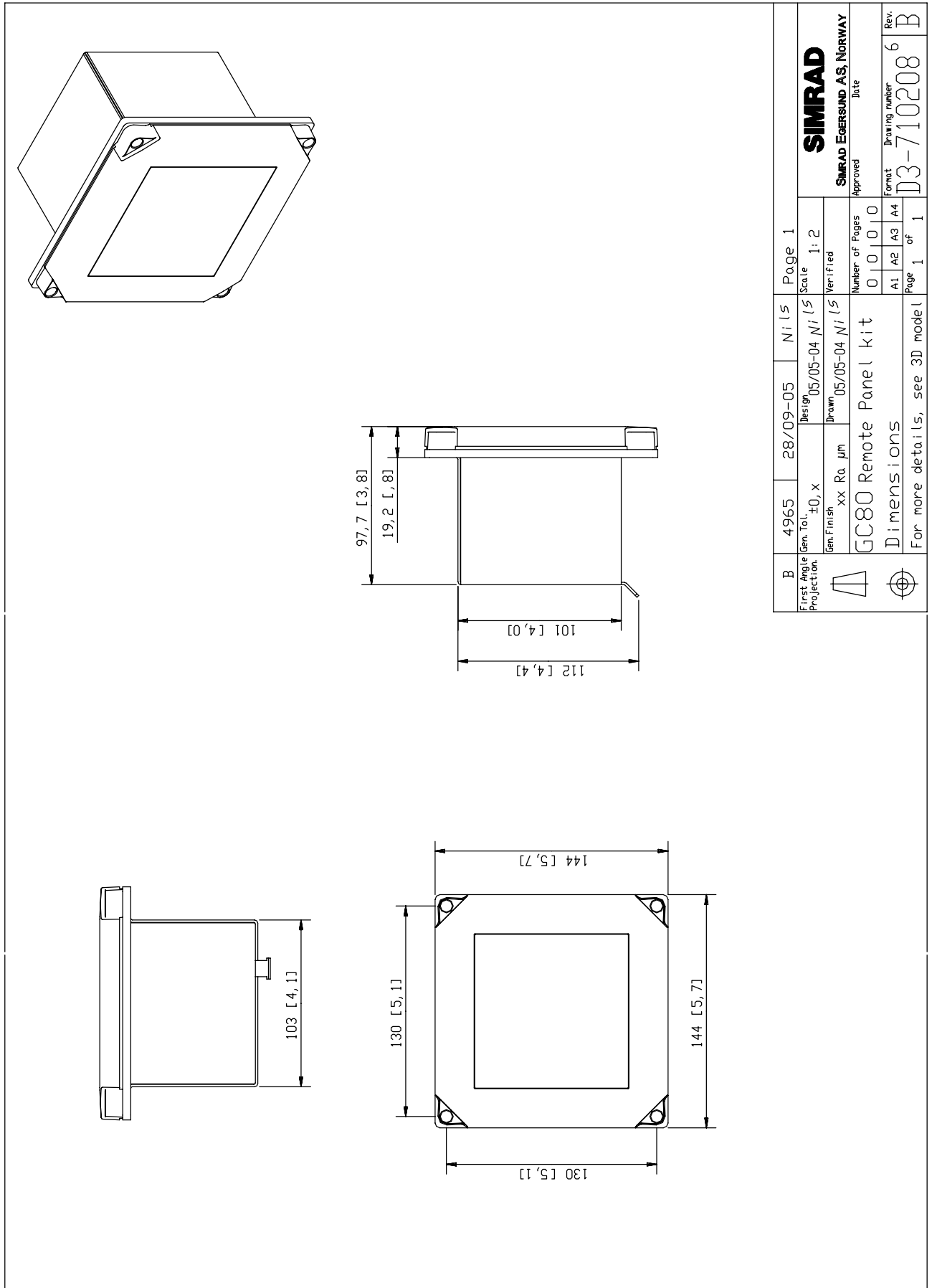

B	4965	28/09-05	Ni/LS	Page 1
	Gen. Tol. ±0, x	Design 05/05-04 Ni/LS	Scale 1:2	
First Angle Projection	Gen. Finish xx Ra μm	Drawn 05/05-04 Ni/LS	Verified	
	GC80 Remote Panel kit		Number of Pages 0 0 0 0	
	Dimensions		A1 A2 A3 A4	
For more details, see 3D model				Page 1 of 1
			Approved	
			SIMRAD SIMRAD EBERSUND AS, NORWAY Date	
			Format	D3-710208 ⁶
			Drawing number	Rev.
				B

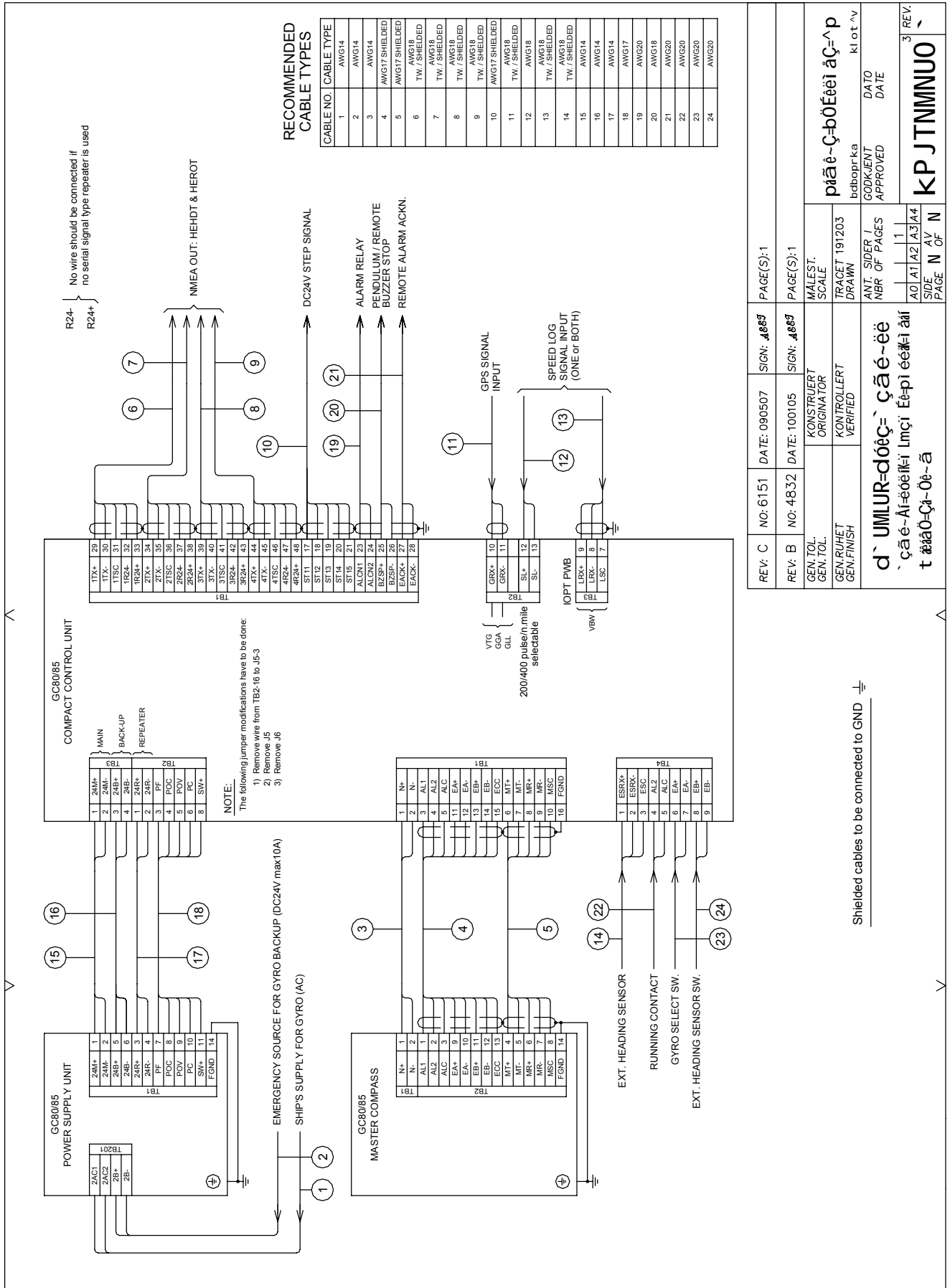



REV: C	NO: 6151	DATE: 090507	SIGN: <i>[Signature]</i>	PAGE(S): 1
REV: B	NO: 4832	DATE: 100105	SIGN: <i>[Signature]</i>	PAGE(S): 1
GEN. TOL. GEN. TOL.	KONSTRUKTÖR ORIGINATOR		MALEST. SCALE	TRACET 191203 DRAWN
GEN. RUHET GEN. FINISH	KONTROLLER VERIFIED		ANT. SIDER I NBR OF PAGES	DATE DATE
d' UMLUR=döğç- çâé-èè çâé-AI-éóéñi Lmç'i Éé-pi ééñi ñi t ñâO-Çâ-Öé-â			pãê-ç-bôéèi àç-^p baboprka Klot. n. GODKJENT APPROVED	3 REV. K P J T M N U O

Shielded cables to be connected to GND

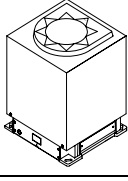

9 SPARE PART LIST

This section includes part numbers for all standard and optional units that may be included in a GC80 and GC85 gyro system.

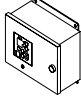

9.1 GC80 Compact Gyro system

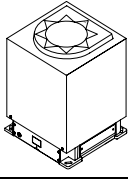
PART NO		DESCRIPTION
27101674		GC80 Master compass
44174027		GC80 Sensitive element
27101690		GC80 Compact Control unit
20221511		GC80/GC85 Compact gyro compass Instruction manual
44174449		Special tool required when installing the Sensitive element

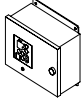
9.2 GC85 Compact Gyro system

PART NO		DESCRIPTION
27101682		GC85 Master compass
44170728		GC85 Sensitive element
27101690		GC80 Compact Control unit
20221511		GC80/GC85 Compact gyro compass Instruction manual
44174449		Special tool required when installing the Sensitive element

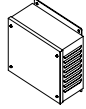
9.3 GC80/GC85 Optional equipment

PART NO		DESCRIPTION
27101724		GC80/GC85 Power supply unit
27101757		GC80 Flush mounting kit in Simrad design for remote installation of operating panel
44170736		GC80 Extension cable 5 meter for remote installation of operating panel normally mounted in Control unit
44170744		GC80 Extension cable 10 meter for remote installation of operating panel normally mounted in Control unit
44170751		GC80 Extension cable 15 meter for remote installation of operating panel normally mounted in Control unit

**THIS PAGE INTENTIONALLY LEFT
BLANK**

10 TERMINAL LAYOUT

This section includes tables which list all terminal pins and terminal labelling on pcbs in the GC80 Control unit. The tables include detailed description for each terminal.

10.1 ITERM board

TB1

PIN NO	NAME	DETAILS
1	N+	Master compass power supply (24V DC)
2	N-	Master compass power supply (24V DC common)
3	AL1	Master compass inverter alarm (over current)
4	AL2	Master compass inverter alarm (over voltage)
5	ALC	Master compass inverter alarm (common)
6	MT+	Control unit – master compass serial signal
7	MT-	
8	MR+	Master compass – control unit serial signal
9	MR-	
10	MSC	Serial signal common
11	ECA+	Master compass encoder signal (A phase)
12	ECA-	
13	ECB+	Master compass encoder signal (B phase)
14	ECB-	
15	ECC	Master compass encoder signal (common)
16	FGND	Earth
17	ST11	Step signal (open drain signal)
18	ST12	
19	ST13	
20	ST14	Step signal (24V DC common)
21	ST15	Step signal (24V DC)
22		Not used
23	ALCN+	Alarm contact signal output
24	ALCN-	
25	BZSP+	Buzzer stop signal input
26	BZSP-	
27	EACK+	External acknowledge signal input
28	EACK-	
29	1TX+	Serial signal output
30	1TX-	
31	1TSC	Serial signal common
32	1R24-	Serial repeater power supply (24V DC common)
33	1R24+	Serial repeater power supply (24V DC)

PIN NO	NAME	DETAILS
34	2TX+	Serial signal output
35	2TX-	
36	2TSC	Serial signal common
37	2R24-	Serial repeater power supply (24V DC common)
38	2R24+	Serial repeater power supply (24V DC)
39	3TX+	Serial signal output
40	3TX-	
41	3TSC	Serial signal common
42	3R24-	Serial repeater power supply (24V DC common)
43	3R24+	Serial repeater power supply (24V DC)
44	4TX+	Serial signal output
45	4TX-	
46	4TSC	Serial signal common
47	4R24-	Serial repeater power supply (24V DC common)
48	4R24+	Serial repeater power supply (24V DC)

TB2

When used with Simrad Power supply unit (OPTION):

PIN NO	NAME	DETAILS
1	24R+	Power unit 24R input
2	24R-	Power unit 24RC input
3	PF	Power unit alarm input
4	POC	
5	POV	
6	PC	
7	SWV	Not used
8	SW+	Power unit switch signal
9	SW-	Not used
10	GRX+	GPS serial signal input
11	GRX-	
12	SL+	LOG contact signal input
13	SL-	
14	FGND	Earth
15		Not used
16		

TB3

When used with 24V DC main:

PIN NO	NAME	DETAILS
1	24M+	External power supply input
2	24M-	
3	24B+	Not used
4	24B-	
5	24BT+	Battery backup
6	24BT-	

When used with non Simrad Power supply unit:

PIN NO	NAME	DETAILS
1	24M+	External power supply input
2	24M-	
3	24B+	
4	24B-	
5	24BT+	Battery backup
6	24BT-	

10.2 IOPT board

TB3

PIN NO	NAME	DETAILS
1	ESSC	Not connected
2	ESTX-	
3	ESTX+	
4	PRSC	
5	PRRX-	
6	PRRX+	
7	LSC	Log serial signal input common
8	LRX-	Log serial signal input (NMEA)
9	LRX+	
10	TKSC	Not connected
11	TKTX-	
12	TKTX+	

TB4

PIN NO	NAME	DETAILS
1	ESRX+	External sensor serial signal input
2	ESRX-	
3	ESC	External sensor serial signal common
4	RNCN1	Running contact signal output
5	RNCN2	
6	GCCN+	Gyro select signal input (External switch)
7	GCCN-	
8	ECCN+	External sensor select signal input (External switch)
9	ECCN-	
10	SEL1	Not used
11	SEL2	
12	SELC	

**THIS PAGE INTENTIONALLY LEFT
BLANK**

11 DIP SWITCH SETTINGS

This section includes drawings for the different printed circuits boards in the Control unit that include jumpers and dip switches.

11.1 Compact control unit

Three different boards in the Compact control unit have jumpers and/or dip switches that may be used for configuring the GC80/85 system.

Only a few of these jumpers/dip switches are used in installation and pre-running procedure for the gyro compass. Refer ***Jumper settings in Compact Control unit***, page 39, and ***Dip-switch and jumper settings***, page 42.

The following pages includes drawings showing location of jumpers and/or dip switches, together with a short description for the different settings.

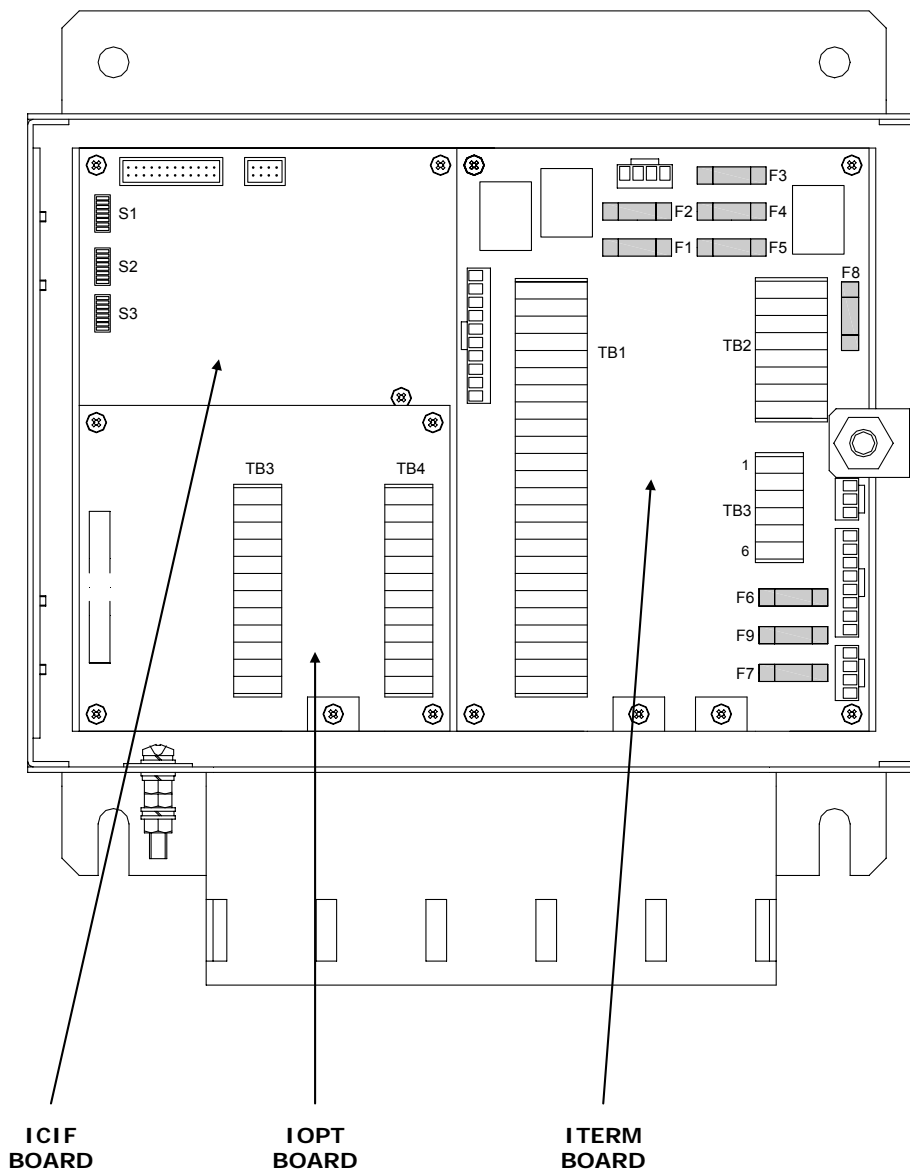

ICIF board

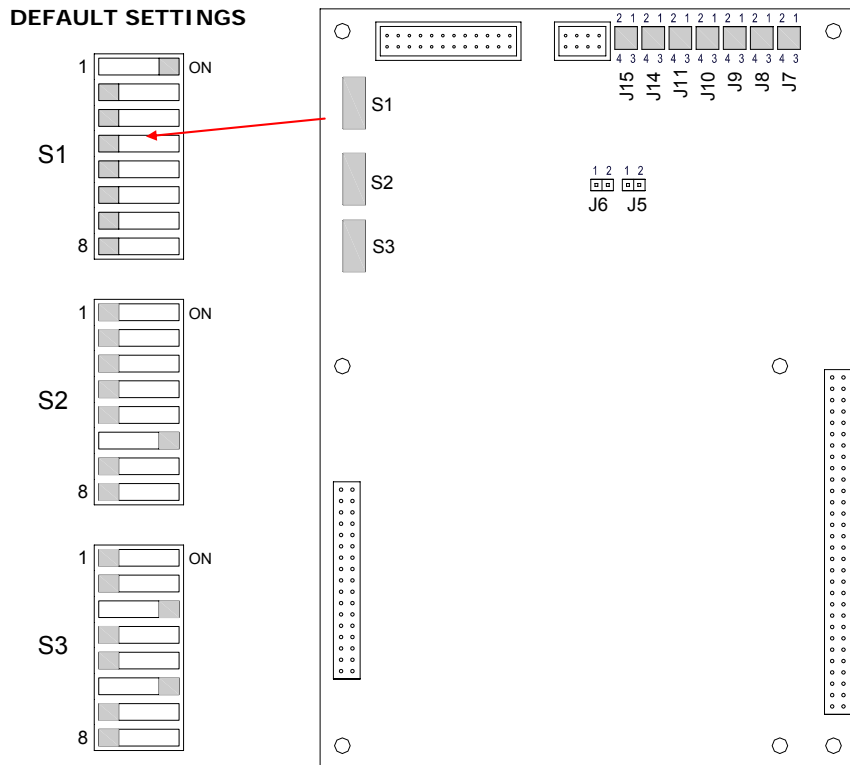

DIP switch settings on ICIF board

SWITCH	DEFAULT	FUNCTION	DESCRIPTION	
S1-1	ON	Control unit type	OFF = Expanded, ON =Compact	
S1-2	OFF	Master compass type	OFF = Standard, ON =High Speed	
S1-3	OFF	Control unit type	OFF = Expanded, ON =Dual	
S1-4	OFF	2 gyros used	OFF = No, ON =Yes	
S1-5	OFF	External sensor connection	SW1-5 OFF	= No external sensor
			SW1-6 OFF	
			SW1-5 ON	Not used
			SW1-6 ON	
S1-6	OFF		SW1-5 ON	= External sensor connected
			SW1-6 OFF	
			SW1-5 ON	Not used
			SW1-6 ON	
S1-7	OFF	Serial signal format	OFF = IEC61162-2 (NMEA0183, ref. page 4), ON = Tokimec	
S1-8	OFF	Alarm output setup	OFF = All alarms, ON = Only power failures	

SWITCH	DEFAULT	FUNCTION	DESCRIPTION	
S2-1	OFF	Used for debugging		
S2-2	OFF			
S2-3	OFF	Not used.		
S2-4	OFF	Pendulum ferry	OFF = Disabled ON = Enabled	
S2-5	OFF	Serial signal transmit frequency IEC61162-1 ed.2	SW2-5 OFF SW2-6 OFF	= 1sec (1Hz)
			SW2-5 OFF SW2-6 ON	= 100msec (10Hz)
S2-6	ON		SW2-5 ON SW2-6 OFF	= 200msec (5Hz)
			SW2-5 ON SW2-6 ON	= Invalid
S2-7	OFF		Not used.	
S2-8	OFF			
S3-1	OFF	Timer startup	OFF = No, ON = Yes	
S3-2	OFF	Talker ID of "ROT" sentence	OFF = "HE", ON = "TI"	
S3-3	ON	Not used		
S3-4	OFF			
S3-5	OFF	Ban or permission of a "ROT" sentence output	Valid at the time of external sensor (standard) selection. OFF = Disabled, ON = Enabled	
S3-6	ON	For Simrad use	OFF = Not used ON = Simrad GC type (80 or 85) shown in display at start-up according to S1-2 setting.	
S3-7	OFF	Not used		
S3-8	OFF			

Jumper settings on ICIF board

JUMPER	DEFAULT	FUNCTION	DESCRIPTION
J5	Short	Software installation	Open = Software may be installed on ICIF board <i>NOTE: Make sure that also J1 on the IOPT board is set to "Open"</i> <i>NOTE: Control unit will be damages if new software is installed with this jumper ON!</i>
J6	Open	CUP reset	Used when resetting the CPU
J7	3-4 short	Output serial signal selection	Output port: ITERM board, TB1 "1TX" 1-2 short = IEC61162-2 or TOKIMEC version 3-4 short = IEC61162-1 ed.2 (ref. page 4) <i>NOTE: Never use both jumpers at the same time!</i>
J8	3-4 short		Output port: ITERM board, TB1 "2TX" 1-2 short = IEC61162-2 or TOKIMEC version 3-4 short = IEC61162-1 ed.2 (ref. page 4) <i>NOTE: Never use both jumpers at the same time!</i>
J9	3-4 short		Output port: ITERM board, TB1 "3TX" 1-2 short = IEC61162-2 or TOKIMEC version 3-4 short = IEC61162-1 ed.2 (ref. page 4) <i>NOTE: Never use both jumpers at the same time!</i>
J10	3-4 short		Output port: ITERM board, TB1 "4TX" 1-2 short = IEC61162-2 or TOKIMEC version 3-4 short = IEC61162-1 ed.2 (ref. page 4) <i>NOTE: Never use both jumpers at the same time!</i>
J11	1-2 short		Polarity for "GPS" signal setting

JUMPER	DEFAULT	FUNCTION	DESCRIPTION
J14	1-2 short	LOG pulse selection	Input port: ITERM board, TB2 "SL" 1-2 short = 200p.p.n.m. 3-4 short = 400p.p.n.m. <i>NOTE: Never use both jumpers at the same time!</i>
J15	3-4 short	Alarm contact output	Output port: ITERM board, TB1 "ALCN" 1-2 short = Alarm CLOSED, Normal OPEN 3-4 short = Alarm OPEN, Normal CLOSED <i>NOTE: Never use both jumpers at the same time!</i>

IOPT board

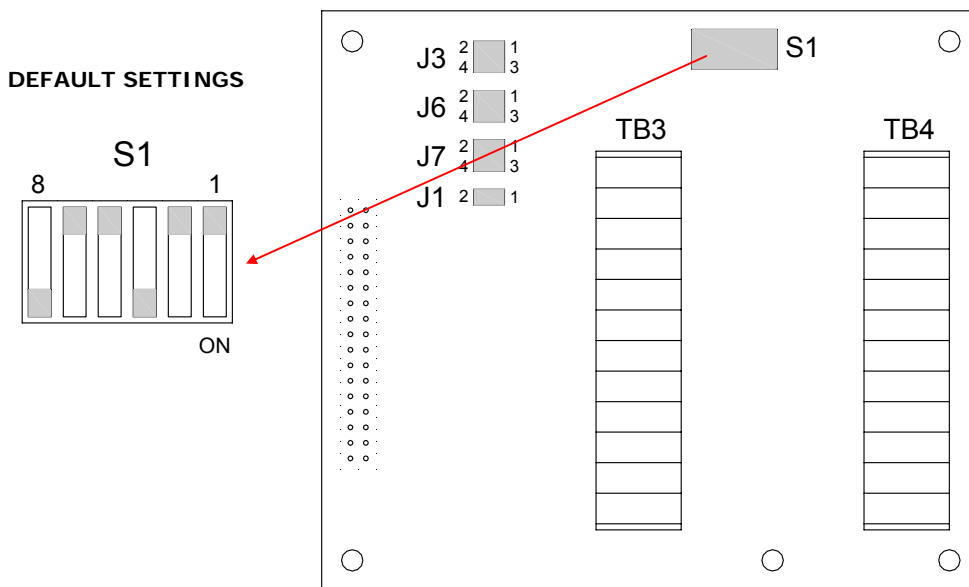

DIP switch settings on IOPT board

SWITCH	DEFAULT	FUNCTION	DESCRIPTION
S1-1	OFF	LOG (serial) baud rate for transmission	38400 bps
S1-2	OFF		9600 bps
S1-3	ON		4800 bps
S1-4	OFF	LOG (serial) baud rate for receive	38400 bps
S1-5	OFF		9600 bps
S1-6	ON		4800 bps

Jumper settings on IOPT board

JUMPER	DEFAULT	FUNCTION	DESCRIPTION
J1	1-2 short	Software installation	Open = Software may be installed in ICIF board <i><u>NOTE:</u> Control unit will be damages if new software is installed with this jumper ON!</i>
J3	1-2 short	Running contact output	Output port: IOPT board TB4 "RNCN" 1-2 short = Running "Closed", Normal "Open" 3-4 short = Running "Open", Normal "Closed" <i><u>NOTE:</u> Never use both jumpers at the same time!</i>
J6	1-2 short	Polarity of "LOG" signal setting	Input port: IOPT board TB1 "L RX" 1-2 short = Standard 3-4 short = Reversed polarity <i><u>NOTE:</u> If a signal not is received with 1-2 short, 3-4 should be set to short.</i> <i><u>NOTE:</u> Never use both jumpers at the same time!</i>
J7	1-2 short	Polarity of "External heading sensor" signal setting.	Input port: IOPT board TB1 "ESRX" 1-2 short = Standard 3-4 short = Reversed polarity <i><u>NOTE:</u> If a signal not is received with 1-2 short, 3-4 should be set to short.</i> <i><u>NOTE:</u> Never use both jumpers at the same time!</i>

ITERM board

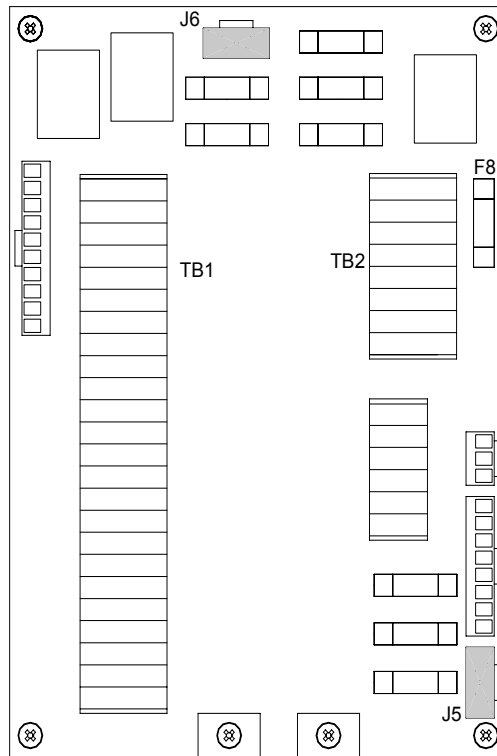

Jumper settings without Power supply unit

JUMPER	DEFAULT	FUNCTION	DESCRIPTION	
J5	-	System used without Power supply unit	1-3 short	No Power supply unit
			2-4 short	
J6	-	System used without Power supply unit	J5-3 to TB2-16 short	No Power supply unit
			1-3 short	
			2-4 short	

Jumper settings with Power supply unit

JUMPER	DEFAULT	FUNCTION	DESCRIPTION	
J5	-	System used with Power supply unit	All open	With Power supply unit
J6	-		All open	

Note! *Remove the wire connecting TB2-16 and J5-3. Refer page 39*

12 ALARM MESSAGES AND CORRECTIVE ACTIONS

This section provides a description which system errors that are displayed, and which corrective actions that could be performed by the system operator.

12.1 The alarm system

The GC80/GC85 system will continually check for faults while the system is running.

If a fault occurs, an alarm code will be displayed in the LCD, the Alarm lamp will be flashing, and an audible alarm will be activated.

Note!

The audible and visual alarm may be disabled by dipswitch S1-8 on the ICIF board (refer page 91). If so, a failure is only indicated by flashing display.

Up to 4 alarm codes may be displayed in the LCD to indicate that several alarm situations are present. The last activated alarm will be displayed on the right side of the display. The figure below shows that alarm with code 1, 3 and 2 were generated in that order.

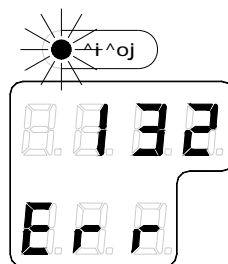

If more than 4 alarms are active, this will be indicated with a dot behind the last number as shown on the figure below. Further alarm codes may then be displayed by pressing the “arrow up” button.

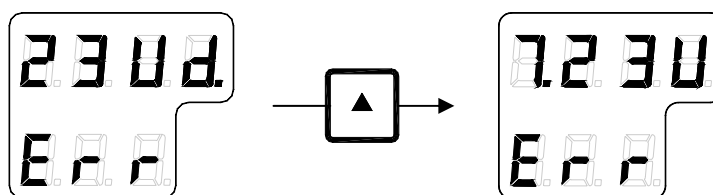

The example shows that alarm code 2, 3, U, d and 7 were activated.

Caution

When an alarm is generated, bearing information from the GC80/GC85 may not be present or may have large error. Any equipment using bearing information from the gyro compass should therefore immediately be operated according to the equipment’s emergency operating procedure.

12.2 Acknowledging an alarm



An alarm is acknowledged by pressing the **ACK/ENT** button.

- The audible alarm will be silenced
- If the alarm situation has disappeared, the alarm lamp will be switched off, and the alarm code will be removed from the LCD
- If the alarm situation continues, the alarm lamp will switch from flashing to steady light. The LCD will return to show true bearing with flashing numbers to indicate that the bearing may have large errors

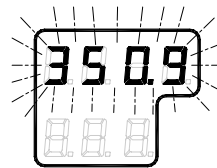

An alarm code for an active error may be recalled by pressing the **DISP** button until the alarm display is shown. It is possible to recall any alarm code in the LCD for as long as the alarm situation is present.

12.3 Fault finding

When an alarm is generated and not removed by pressing the **ACK/ENT** button, further actions should be taken to correct the alarm situation.

The following pages present an overview of symptoms and corrective actions for faults that may be corrected by the operator. If none of these procedures correct the problem, contact the local Simrad dealer for advice or for requesting on board service.

Before any fault finding procedure is started, the following actions should be performed to verify a system error:

- Shut down and restart the gyro compass
- Verify that all cables are properly connected according to the wiring diagrams, page 71 onwards
- Check the cables from the main power supply to the Control unit

Main power failure



Alarm generated when the main power supply is lost.

Caution

Turn OFF the power as described in page 11 before checking the main power supply.

- 1** Verify that the main power switch inside the Control unit is switched ON.
- 2** Check the input from the power supply to the Control unit:
Terminal board/Terminal:ITERM/ TB1, 24M+ and 24M-
Voltage:24V DC +30% / -20%
- 3** Check the cables from the main power supply to the Control unit
- 4** Remove power to the Control unit and check the fuse:
F101: 6.3A

For location and replacement of the fuses, refer to page 30 onwards.

Internal power failure in Control unit



Generated when the Control unit's power supply are over current or over voltage.

- 1 Turn OFF the power by pressing the **POWER** button, and repress the **POWER** button after 20 seconds.
- 2 If no alarm is activated, continue the start-up procedure as described in *Start-Up*, page 10.
- 3 If the alarm is repeated, contact Simrad's local dealer for assistance.

Inverter failure



Alarm generated in the Inverter in the Master compass is over current or over voltage.

- 1 Turn OFF the power by pressing the **POWER** button, and repress the **POWER** button after 20 seconds.
- 2 If no alarm is activated, continue the start-up procedure as described in *Start-Up*, page 10.
- 3 If the alarm is repeated, turn OFF the power and check the inverter fuse, F1:12A.

For location and replacement of the fuses, refer to page 30 onwards.

Zero cross failure



This alarm is generated when the reference angle for the compass bearing not can be properly detected, or if a fault is generated in the bearing calculation.

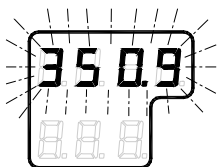

- 1 Press the **DISP** button until the flashing bearing is displayed in the LCD.
- 2 Adjust the bearing with the arrow buttons until the bearing corresponds to the vessel's actual bearing, and confirm the entry with the **ACK/ENT** button.

If the bearing input was accepted by the system, the LCD will display current bearing without flashing.

- 3 Report the error to Simrad even if the bearing is accepted and the alarm removed.

System communication failure



Alarms generated when there is a failure in communication from the Master compass to the Control unit.

- 1 Turn OFF the power by pressing the **POWER** button, and repress the **POWER** button after 20 seconds.
- 2 If no alarm is activated, continue the start-up procedure as described in *Start-Up*, page 10.
- 3 If the alarm is repeated, turn OFF the power and disconnect the power cable to the Control unit.
- 4 Confirm the connection between the terminal board in the Master compass and the terminal board in the Control unit as shown below:
 - GC80 Master compass:
TB1, MR+/-
 - GC80 Compact Control unit:
GTERM PWB, TB1, MR+/-

GPS communication or data failure



Generated when if the communication from GPS has stopped (**G**), or when there is a failure in the communication line from the GPS (**D**).

Note!

This alarm is only generated when GPS is selected as the vessel's input source for latitude or speed.

- 1 Verify that the GPS operates according to the GPS documentation.
- 2 If the GPS has a failure, change the input source as described in *Setting the Latitude input source*, page 52 and *Setting the Speed input source*, page 53.

Caution

Any alarm generated by a failure in the GPS may cause large errors in the bearing output.



Internal communication failure

Generated when the communication from the external bearing sensor has stopped (**E**), or when a failure is detected in the communication (**E**).

Caution

When these alarms are generated, the bearing information from the external bearing sensor may have large error.

- 1 Verify that the external bearing sensor operates correctly according to the system's documentation.



External bearing sensor failure

Generated when the serial signal from the external bearing sensor has stopped (**L**), or when a failure is detected in this serial signal (**n**).

Note!

This alarm is only generated when the external bearing sensor is selected as active bearing output source.

- 1 Verify that the external bearing sensor operates correctly according to the system's documentation.



LOG (serial) communication or data failure

Activated when the serial signal from LOG (serial) has stopped (**P**), or when a failure is detected in the serial signal from the LOG (**U**).

Note!

This alarm is only generated when GYRO is selected as the active bearing output source, and when LOG (serial) is selected as the vessel's speed input source.

- 1 Verify that the LOG operates according to the LOG documentation.
- 2 If the LOG has a failure, change the input source as described in *Setting the Speed input source*, page 53.

Repeater failure

No output on single repeaters

- 1 Check that the repeater is connected to the gyro according to the repeater's documentation.
- 2 Each repeater output has a separate fuse in the Control unit. Disconnect the power to the Control unit, and check the fuse for the repeater not working:
 - Step repeater:
F5: 1A
 - Serial repeater:
F1 to F4: 1A

For location and replacement of the fuses, refer to page 32 onwards.

No output on any repeater

- 1 Disconnect the power to the Control unit, and check the following fuses:
F8: 6,3A

For location and replacement of the fuses, refer to page 32 onwards.

Failure when powering ON the gyro compass

If alarm code **B** and **A** are generated simultaneously when the GC80 system is turned ON, the following procedure should be used to correct the alarm situation:

- 1 Press the **POWER** button to turn OFF the system, and repress the button after 1 second.
- 2 If the alarm status remains, remove the power to the system and verify the fuse for the inverter.

For location and replacement of the fuses, refer to page 30 onwards.

12.4 Complete alarm code list

Alarm code	Alarm content	Detailed code	Possible cause
E-1	Main power is abnormal	1	When the main power (AC power source) is lost.
E-2	Power is abnormal	2	Power supply unit in the control box becomes over current.
		3	Power supply unit in the control box becomes over voltage.
		4	24R is lost.
E-3	Inverter is abnormal	5	Inverter in the master compass becomes over current.
		6	Inverter in the master compass becomes over voltage.
E-4 *1	Control power is abnormal	7	+12.5V is abnormal.
		8	-12.5V is abnormal.
		9	+10V is abnormal.
		10	-10V is abnormal.
E-5 *1	Rotor current is abnormal	11	Gyro rotor current is abnormal.
E-6	Rotor tilting angle is abnormal	12	Rotor tilting angle is abnormal.
E-7 *1	Servo loop is abnormal	13	Horizontal servo loop is abnormal.
		14	Bearing servo loop is abnormal.
		15	Rate limit is abnormal.
E-8	Zero cross is abnormal	36	Zero cross azimuth angle sensor is abnormal.
E-9 *1	Memory is abnormal	16	Memory is abnormal
		17	Memory is abnormal
		18	Memory is abnormal
		19	Memory is abnormal
		20	Memory is abnormal
E-A	Communication error (1)	21	Communication error (MCC→SCC).
		23	MCC is reset.
E-b *1	Communication error (2)	22	Communication error (SCC→MCC).
		24	SCC is reset.
E-c	GPS communication off	25	When GPS system is stopped or serial signal from GPS is cut. (timeout is 15 sec.)
E-d	GPS data abnormal	26	GPS latitude data abnormal. (timeout is 17 sec.)
		27	GPS speed data abnormal.(timeout is 17 sec.)
E-E	MAG/EHS communication off	32	When MAG/EHS system is stopped or serial signal from GPS is cut. (timeout is 15 sec.)

Alarm code	Alarm content	Detailed code	Possible cause
E-F	MAG/EHS data abnormal	33	EHS data abnormal. (timeout is 17 sec.)
E-L	EXT. sensor communication off	30	When EXT. sensor system is stopped or serial signal from EXT. sensor is cut. (timeout is 15 sec.)
E-n	EXT. sensor data abnormal	31	EXT. sensor data abnormal.(timeout is 17 sec.)
E-P	LOG(serial) communication off	28	When LOG (serial) source is stopped or serial signal from LOG (serial) is cut. (timeout is 15 sec.)
E-U	LOG(serial) data abnormal	29	LOG (serial) data abnormal.(timeout is 17 sec.)
E-r	E5V is lost	34	E5V (power supply of serial signal) is lost.
E-G	Master bearing is abnormal	35	When compensation of the bearing by the encoder signal is not completed.
E-u *1	LOG(contact) data abnormal	37	LOG (contact) is abnormal.

*1: This alarm code is not displayed to customer.