

# Manual

## Simrad IS20 Analog Instrument series

English

Sw.1.2

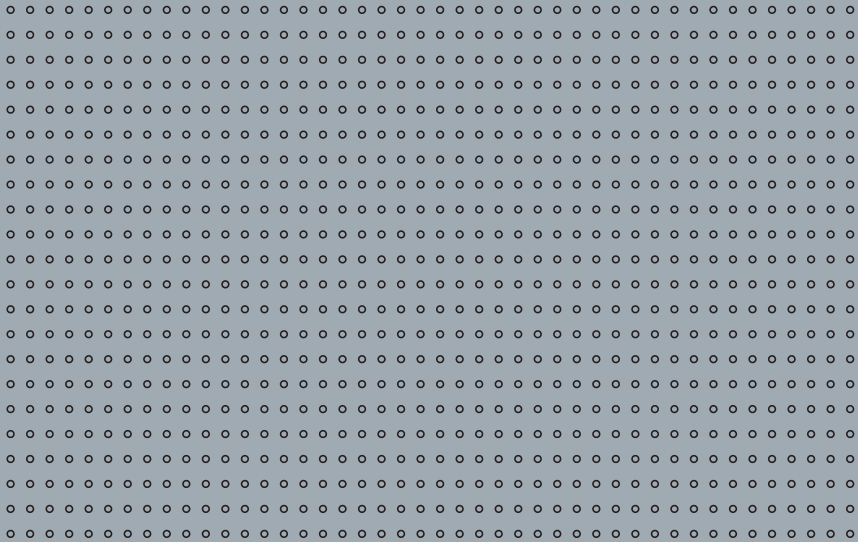

# Manual

## Simrad IS20 Analog Instrument series

English                      Sw.1.2

Document no: 20222584

Revision:            B

Date:                March 2008

The original language for this document is English. In the event of any discrepancy between translated versions and the English version of this document, the English document will be the official version.

To the best of our knowledge, the content in this publication was correct at the time of printing.

As we are continuously improving our products we retain the right to make changes to the product and the documentation at any time. Updated manuals are available from our website [www.simrad-yachting.com](http://www.simrad-yachting.com), and are free to download.

© Copyright 2008 by Navico Holding AS.

## About this manual

This manual is a reference guide for installing and operating the Simrad IS20 Graphic instrument.

The manual does not include operator or installation procedures for sensors that can be connected to the system.

In this manual, names of menu commands, dialog box text and keys are written in boldface (e.g. **Main** menu, **Setup** command, **Left** key).

Important text that requires special attention from the reader is emphasized as follows:



*Used to draw the reader's attention to a comment or some important information.*



*Used when it is necessary to warn personnel that a risk of damage to the equipment or hazard exists if care is not exercised.*

# Content

<b>1 Introduction</b> .....	<b>5</b>
1.1 General information.....	5
1.2 Instrument layout .....	5
1.3 IS20 system examples.....	6
<b>2 Operation</b> .....	<b>9</b>
2.1 Turning the IS20 on .....	9
2.2 Backlighting .....	10
2.3 Scrolling through function displays .....	11
2.4 Using the heading lock function.....	13
2.5 Operating the menu system.....	14
2.6 Changing the display settings .....	16
2.7 SimNet backlight group.....	18
2.8 Setting the damping factor .....	19
2.9 Power save function .....	19
2.10 Demo mode.....	20
<b>3 IS20 Alarm system</b> .....	<b>21</b>
3.1 Alarm indication.....	21
3.2 Acknowledging an alarm .....	22
3.3 Alarm codes .....	23
<b>4 Installation</b> .....	<b>25</b>
4.1 Location of the unit .....	25
4.2 Mechanical installation .....	25
4.3 Cable connection.....	27

<b>5 Configuration</b> .....	<b>35</b>
5.1 General .....	35
5.2 No calibration function available .....	35
5.3 IS20 Rudder .....	36
5.4 IS20 Compass .....	40
5.5 IS20 Wind and IS20 Tack .....	45
<b>6 Maintenance</b> .....	<b>49</b>
6.1 General maintenance .....	49
6.2 Resetting the instrument system .....	49
<b>7 Spare parts</b> .....	<b>51</b>
7.1 Spares and auxiliaries .....	51
7.2 SimNet cables and accessories .....	52
<b>8 Specifications</b> .....	<b>53</b>
8.1 Technical specifications .....	53
8.2 Dimensional drawing .....	54
8.3 Menu options .....	55

# 1 Introduction

## 1.1 General information

The IS20 analog instruments are a range of four instruments that provide useful information for the boater in a classical fashion. They are individually designed to a particular main function such as rudder angle, compass heading, wind angle and speed and close hauled sailing. They are all compatible with the unique SimNet network and can easily be mounted adjacent to each other and interconnected in a daisy chain.

A separate NMEA0183 input port allows input from other non-SimNet devices.

## 1.2 Instrument layout



The instruments are provided with a back lighted scale and the pointer is driven by a microstep motor that gives excellent precision and no overshoot. The LCD display offers information complementary to the scale as well as set-up support when installing and calibrating the instrument.

The display may be set to red or white illumination color, and the contrast and light level are adjustable.



The instrument is equipped with 2 SimNet connectors and one NMEA0183 input (listener) connector.

## Keys

The instrument is operated by 4 keys. These are used to scroll between function displays, to adjust the light, to operate the menu and to set parameter values.

## 1.3 IS20 system examples

The IS20 may be installed as a stand-alone instrument system, or as part of an advanced instrument or steering system on the boat.

The figures below show simplified illustrations for basic and an expanded IS20 system.

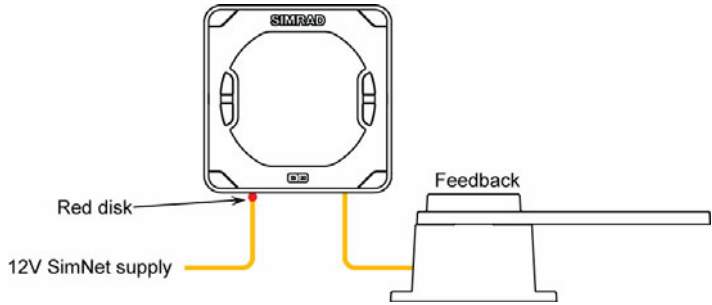

*IS20 Rudder, Basic system*

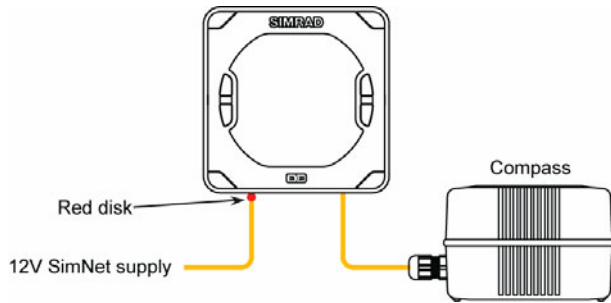

*IS20 Compass, Basic system*

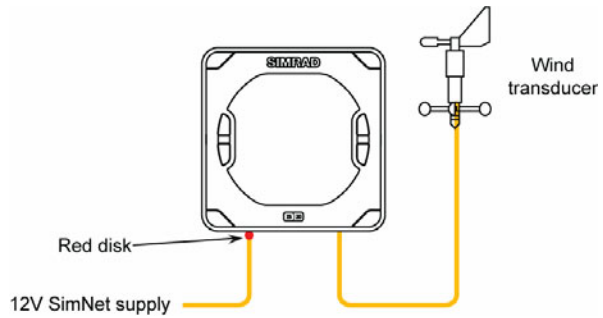

*IS20 Wind or Tack, Basic system*



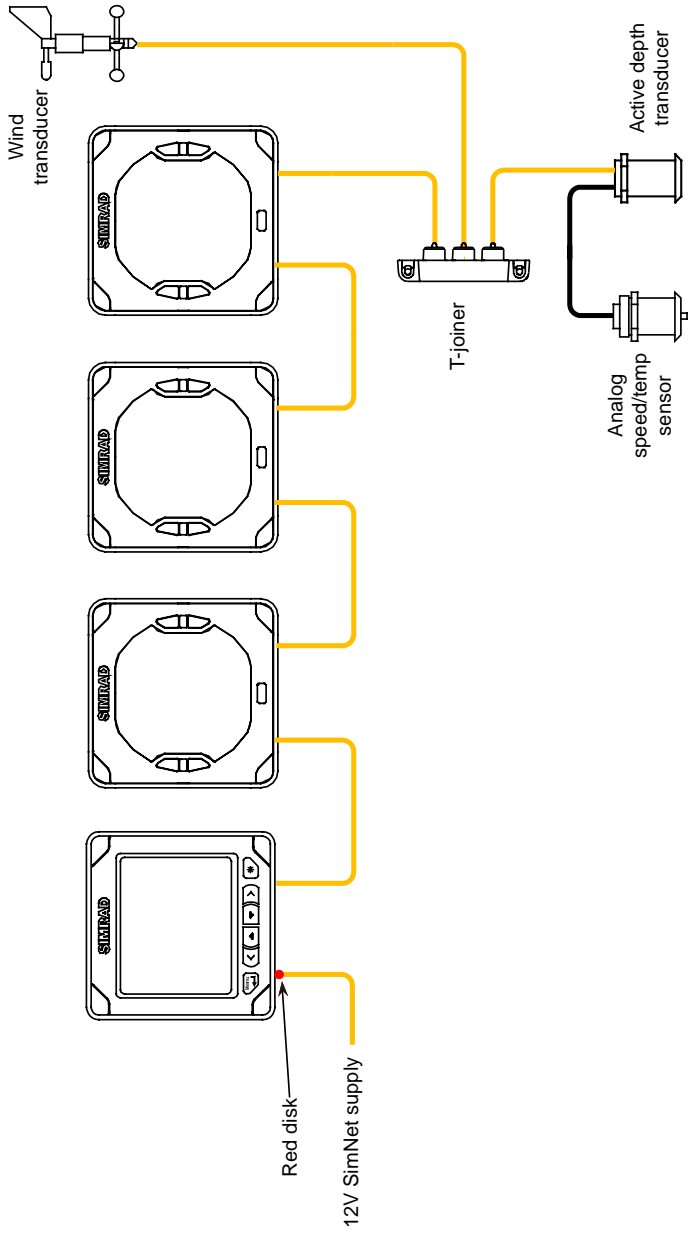

IS20 Expanded system

## 2 Operation



*It is required to read and understand the content in this chapter. The remaining descriptions and illustrations in this manual assumes that the user is familiar with how to operate keys and how to navigate in the menus!*

### 2.1 Turning the IS20 on

IS20 has no power key, and will be running as long as power is connected.



*The IS20 includes a power save function. Refer page 19.*

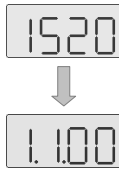

When power is applied the LCD will show the product name (IS20) followed by software version.

After approximately 5 seconds the instrument is operative.

#### First time start up

Before the IS20 is ready to operate, it should be configured as described in **Configuration**, page 35 onwards.

#### Restarting the IS20 instrument

When IS20 is re-powered the display will go directly to the last active function after the start up sequence is finished.

## 2.2 Backlighting

The display backlight may be adjusted at any time.



- 1 Press the light key

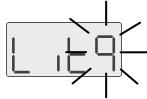

– The light level will be indicated with flashing number on the LCD

- 2 Press one of the keys as described below to change the display backlight:



- a The **Light** key to increase the light level by one step



- b The **Up/Down** keys to increase/decrease the light level by one step



- 3 Press the **Enter** key to confirm the selection and return to last active display

If no adjustment is performed within 3 seconds, the LCD will return to last active view.

For red/white backlight color, refer to **Display color**, page 17.

## 2.3 Scrolling through function displays

The IS20 Analog instruments may show several functions, displayed by using the **Up** and **Down** keys.



← 3 arrows at the top of the LCD indicate which function that is displayed. The arrow symbols are identified by legends printed on the scale.

### *IS20 Rudder / IS20 Compass*



The illustration shows legends used on the IS20 Rudder/Compass instruments to indicate active function as listed below:







LCD		Scale/pointer		
Symbol	Function		Compass	Rudder
	Heading		Heading	Rudder angle
	Magnetic heading			
	True heading			
	Heading lock		Heading	
	On course			
	Off course, steer port			
	Off course, steer starboard			
	Cross track error in 1/1000 NM		Heading	
	Cross track error, steer to starboard			
	Cross track error, steer to starboard			

## IS20 Wind / IS20 Tack



The Wind/Tack instruments can display 5 different functions.

The legends are used to indicate an active function as shown in the table below.

LCD		Scale/pointer
Symbol	Function	
	Apparent wind speed	Apparent wind angle
	True wind speed	True wind angle
	VMG to wind	Apparent wind angle
	VMG to wind	True wind angle
	Wind direction	
	 Magnetic reference	True wind angle
	 True reference	



*Wind direction can only be displayed when heading or course over ground is available as input!*

Speed and velocity may be displayed in knots, miles per hour or meter per second. Refer **Setting the units of measure**, page 47.

## 2.4 Using the heading lock function

The IS20 Rudder and IS20 Compass instruments include a heading lock function.



When this function is activated, the LCD will show heading deviation compared to the vessel's heading when the function was activated.

Use the following procedure to activate the function:



- 1 Steer the vessel on selected heading
- 2 Press the **Up/Down** keys to select the Lock function
- 3 Press the **Enter** key to display the **Lock** menu item
- 4 Again press the **Enter** key to display current heading which is flashing
- 5 Accept current heading by re-pressing the **Enter** key, or change the heading with the **Up/Down** keys followed by the **Enter** key
- 6 Confirm the selection and return to the lock function display by re-pressing the **Enter** key

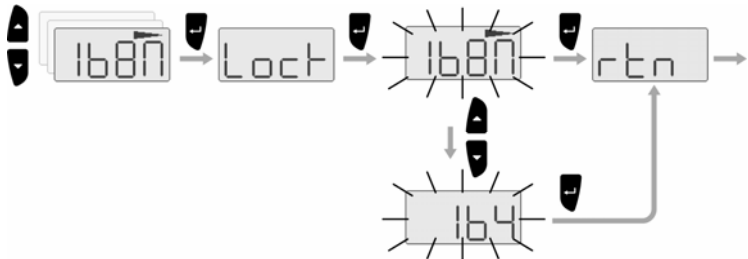

The instrument will keep the selected heading as reference until a new heading is entered as described above.

## 2.5 Operating the menu system



All functions and settings in the IS20 analog instruments are available from the menu system, activated by pressing the **Enter** key.

The keys are used as shown below to navigate in the menu system:

KEY	SINGLE PRESS	PRESS AND HOLD
	Confirm a selection/parameter setting	
	Go to previous/next menu item, increase/decrease parameter value	

The illustration on next page shows menu navigation and required key presses when changing the damping factor from "3" to "4".

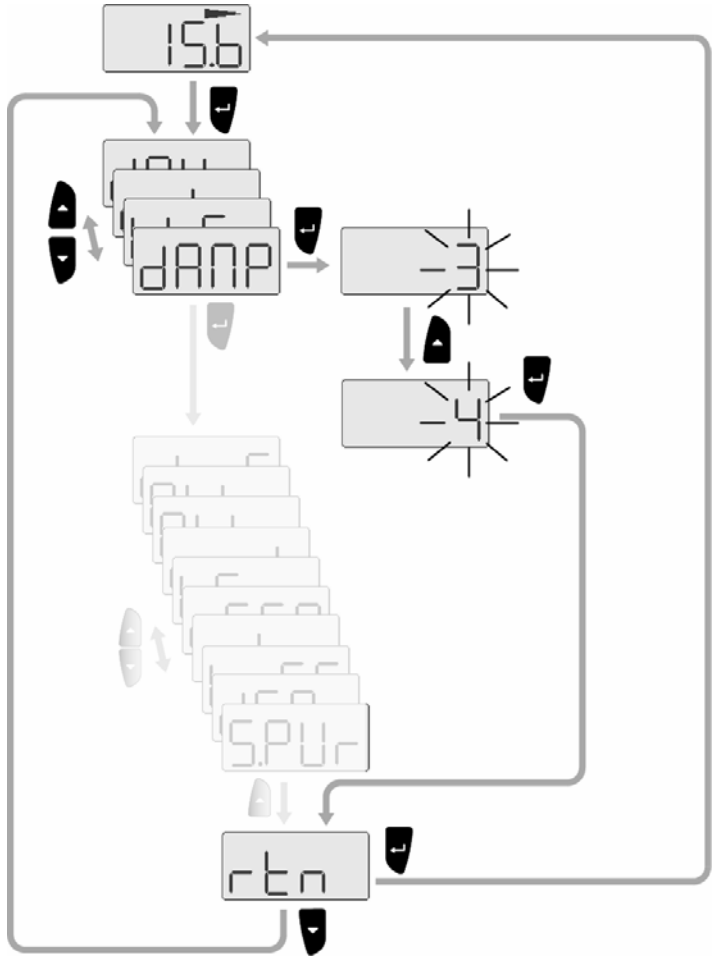



## Menu illustrations

In this manual, the first steps in a menu operation are illustrated by overlapping menu windows.



Number of underlying menu windows are indications only and do not correspond to actual key presses.

When more detailed illustrations are required to show key presses and screens, this is shown as below:

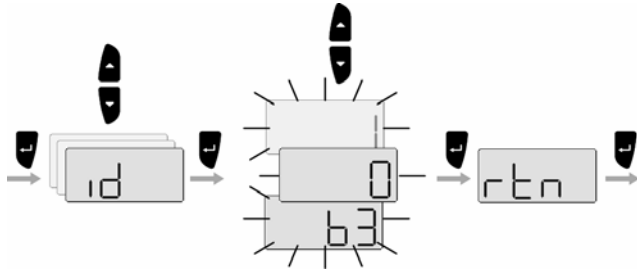

## 2.6 Changing the display settings

To optimize the readability under different light conditions, the instrument backlighting is controlled by 2 settings:

- Light level
- Light color

The light level is controlled by the light key. Refer ***Backlighting***, page 10.



*Color and level also applies for key backlighting!*

## Display profile

The day and night display profiles controls the light color for the display and the keys.

The profiles are utilized in installations where several instruments are configured as part of a SimNet backlight group as described on page 18.

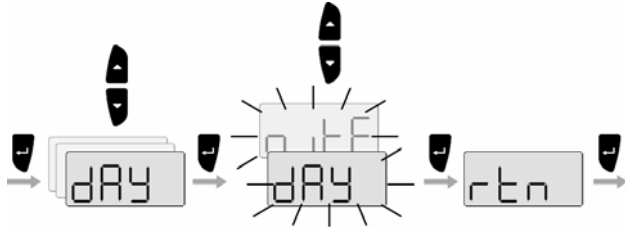

LCD	Parameter	Default
dAY	Day profile	Day
nItE	Night profile	

## Display color

The light color is defined for the selected display profile.

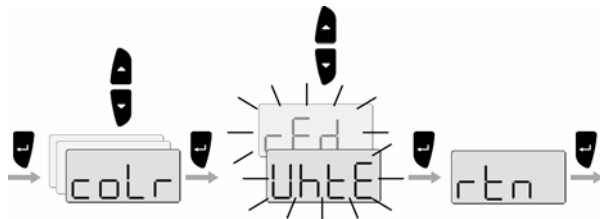

LCD	Parameter	Default
WhTE	White	Day profile: White
rEd	Red	Night profile: Red

## 2.7 SimNet backlight group

The SimNet backlight group function is used to globally control the light setting for groups of units. This option is used on larger vessels where many units are connected via the SimNet network.

By assigning several units to the same group, a backlight change on one unit will have the same effect on the rest of the group members.

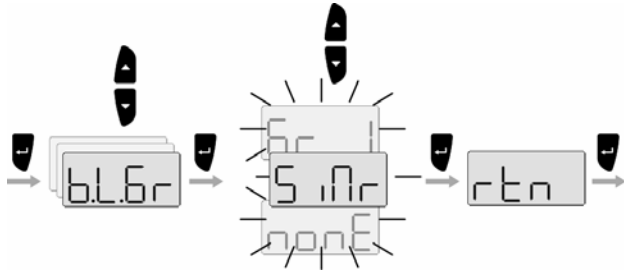

The SimNet backlight groups are normally configured during installation, but may be changed at any time.

The following group settings are available:

Parameter	Options	Default
b.L.Gr	- Simrad <input type="text" value="S i n r"/>	Simrad
	- None <input type="text" value="n o n e"/>	
	- 1 - 6 <input type="text" value="G r 1 - G r 6"/>	

- Simrad: Default group for IS20
- None: Not assigned to a group
- 1 – 6: Group numbers

## 2.8 Setting the damping factor

The damping factors indicate how fast the display will respond to changes.

The higher damping factor the more stable display reading on the instrument.

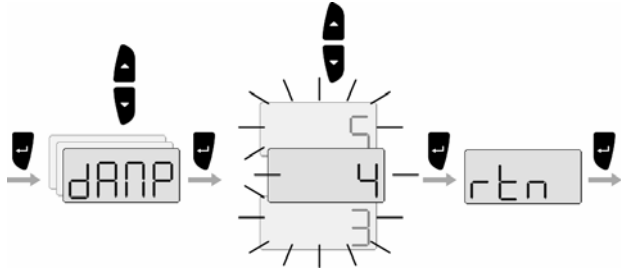

Range	Change per step	Default value
0 - 9	1	4

## 2.9 Power save function



When power save is activated, the display will be turned off.

Any key press or activated alarm will disable the power save function.

## 2.10 Demo mode

The IS20 includes a demo mode useful for demonstrations and on show.

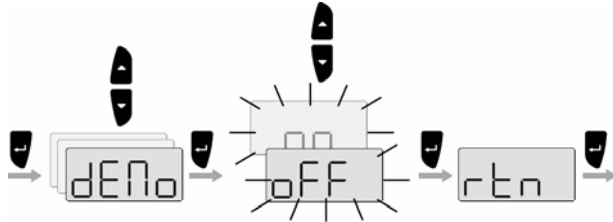

*On an IS20 Analog the demo mode is indicated with the display switching between active mode and "Demo".  
The demo indication will flash more frequently on the demo source than on units that are reading the demo values.*

Demo mode is turned OFF with the same procedure as used when it was turned ON.



*Demo mode must be turned OFF on the same unit where Demo mode was turned ON!*

## 3 IS20 Alarm system

### 3.1 Alarm indication

The alarm system in the IS20 analog instruments is activated if any alarm settings are exceeded. Refer to ***Alarm setup***, page 45.

When an alarm is activated, the alarm will be indicated with an alarm ID and with an audible alarm.

The different alarm indications are shown in the table below.

Alarm type	Sound	Light	Reminder interval
Vital alarm	Constant	Switching on/off	10s
Important alarm	Alternating between 2 tones		20s
Standard alarm		40s	
Warning	Single beep		60s
Light warning	Single beep		

The following alarms are available on the IS20 Analog instruments:

Alarm ID	Alarm	Source
ShAL	Shallow water alarm	
dEEP	Deep water alarm	
AnCh	Anchor watch / change in depth	
chnG	True wind shift alarm	Wind/Tack
High	True wind speed too high	Wind/Tack
Lo	True wind speed too low	Wind/Tack
oFF.C	Off course alarm	
Er.xx	Local unit failure	Internal *
AL.xx	Any other alarm	Any *

\* The xx will be replaced by the global alarm id.  
Refer **Alarm codes**, page 23.

If IS20 Graphic is connected to other SimNet units, any alarm in the system will be displayed on the instrument.

The alarm text is received from the alarm source or from SimNet.

### 3.2 Acknowledging an alarm

An alarm is acknowledged by pressing any key. This will remove the alarm notification (text, light and sound) from the instrument.



*The IS20 Analog instruments do not display any alarm reminders!*



*An alarm received from other SimNet units must be rectified on the unit generating the alarm!*

### 3.3 Alarm codes



If the text is received from other units connected to SimNet, the alarm text may not be displayed. The alarm condition will then be indicated with a code as listed in the table below.

Alarm ID	Alarm
10	Shallow water
11	Deep water
12	Anchor alarm
13	Wind shift
14	True wind speed too high
15	True wind speed too low
16	Boat speed too low
17	Voltage too high
18	Voltage too low
19	Depth data missing
20	Wind data missing
21	Nav data missing
22	Compass data missing
23	Off course
24	Rudder data missing (RF25)
25	Rudder feedback failure (RF300)
26	Rudder response failure
27	Drive overload
28	High temperature
29	Byp/clutch overload
30	Byp/clutch disengaged
31	High drive supply
32	Low drive supply



<b>Alarm ID</b>	<b>Alarm</b>
33	No active control unit
34	No autopilot computer
35	ACXX Memory failure
36	No connection with EVC system
37	EVC override
56	RF must be calibrated

## 4 Installation

### 4.1 Location of the unit

The IS20 should be mounted with special regard to the unit's environmental protection, temperature range and cable length. Refer to page 53.

Avoid mounting the unit where it is easily exposed to sunlight, as this may shorten the lifetime of the display.

### 4.2 Mechanical installation

#### Panel mounting

The mounting surface must be flat and even to within 0.5 mm.

1. Drill the 4 mounting holes and make a panel cut-out according to the drilling template included in the package
2. Use the supplied 19 mm self tapping screws to secure the control unit to the panel
3. Apply the front panel corners



***Do not over-tighten the screws!***

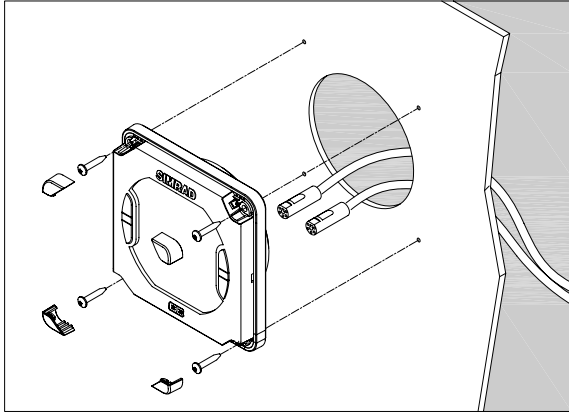

## Bracket mounting

An optional bracket is available for the IS20.

The illustration below shows the mounting details for the bracket.

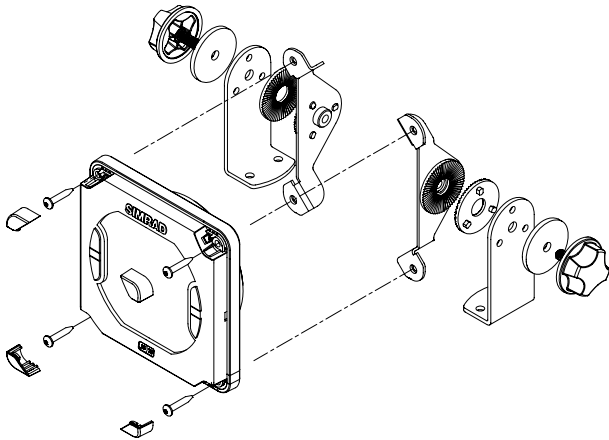

## 4.3 Cable connection

The IS20 may be connected to:

- a SimNet network using SimNet cables
- an NMEA2000 system
- an NMEA0183 output port

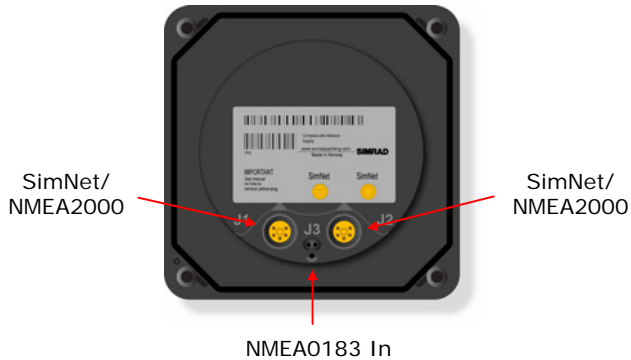

### SimNet

The SimNet cable system with very small plugs in both ends makes it easy to run the cables. Only 10 mm (3/8") holes are required through panels and bulkheads.

The SimNet accessory program contains the necessary items to make a successful installation. Refer ***SimNet cables and accessories***, page 51.

### *SimNet cables*

A SimNet unit has one or two yellow SimNet connectors. There are no dedicated "in" or "out" connectors.

Route the SimNet cables with the figures on page 29, 30 and 31 as a guideline. Select cables and accessories from the SimNet accessory program.

Connect products with two SimNet connectors in a daisy chain and use drop cables and T-joiners when required. For cable extension in-line cable joiners are available.



*Total length of SimNet cable installed in a system should not exceed 150 meter (500')!*

If you plan to extend your SimNet system in the future it may be advantageous to prepare for it by adding a few T-joiners in central locations. The T-joiners provide easy access to the network and can be replaced with a new product, or the new product can be connected via a drop cable.



*The connectors are weather proof according to IP66, when properly installed. All unused SimNet connectors must be fitted with the plastic cap to protect them against dirt and moisture.*

### ***SimNet power and termination***

The following rules should be observed when installing SimNet.

- 1** It must have a separate 12VDC power from the battery bus or the circuit breaker board to reduce interference
- 2** It must not be connected to the supply voltage terminals of the Autopilot Computer
- 3** It will power a SimNet compatible instrument system. Hence SimNet to other equipment can be supplied via the autopilot, see the figures on page 29, 30 and 31
- 4** SimNet must be properly terminated, i.e. unless it is a small system (see the figure on page 29) there must be terminations at each end of the Simrad backbone

The SimNet network has to be terminated according to the number and type of products connected.

In a small system consisting of maximum 5 SimNet products and a total length of 5 m SimNet backbone cable you only need the SimNet power cable with built in termination (red disc on cable plug).

For additional information about SimNet ask for the separate SimNet Manual.

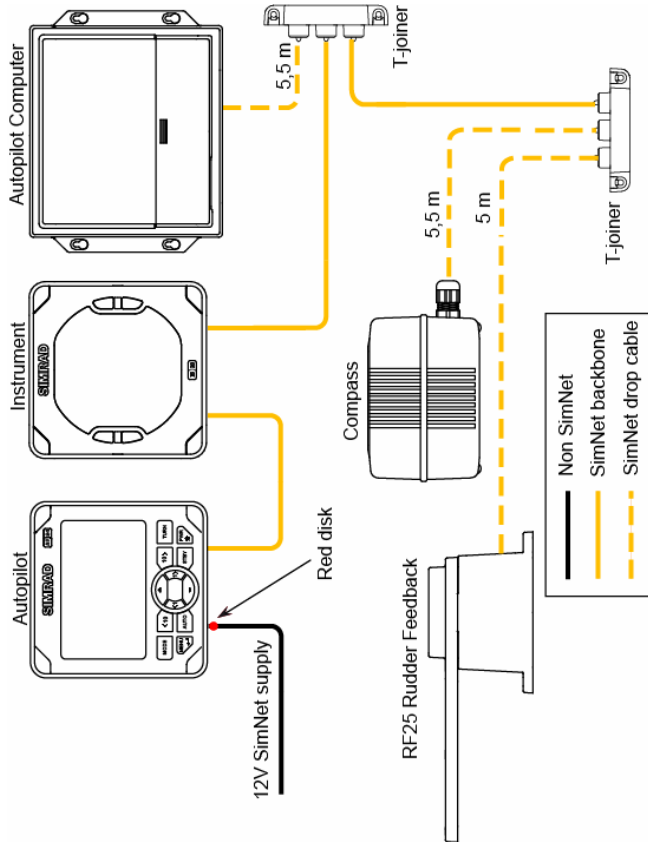

*SimNet network, small system*

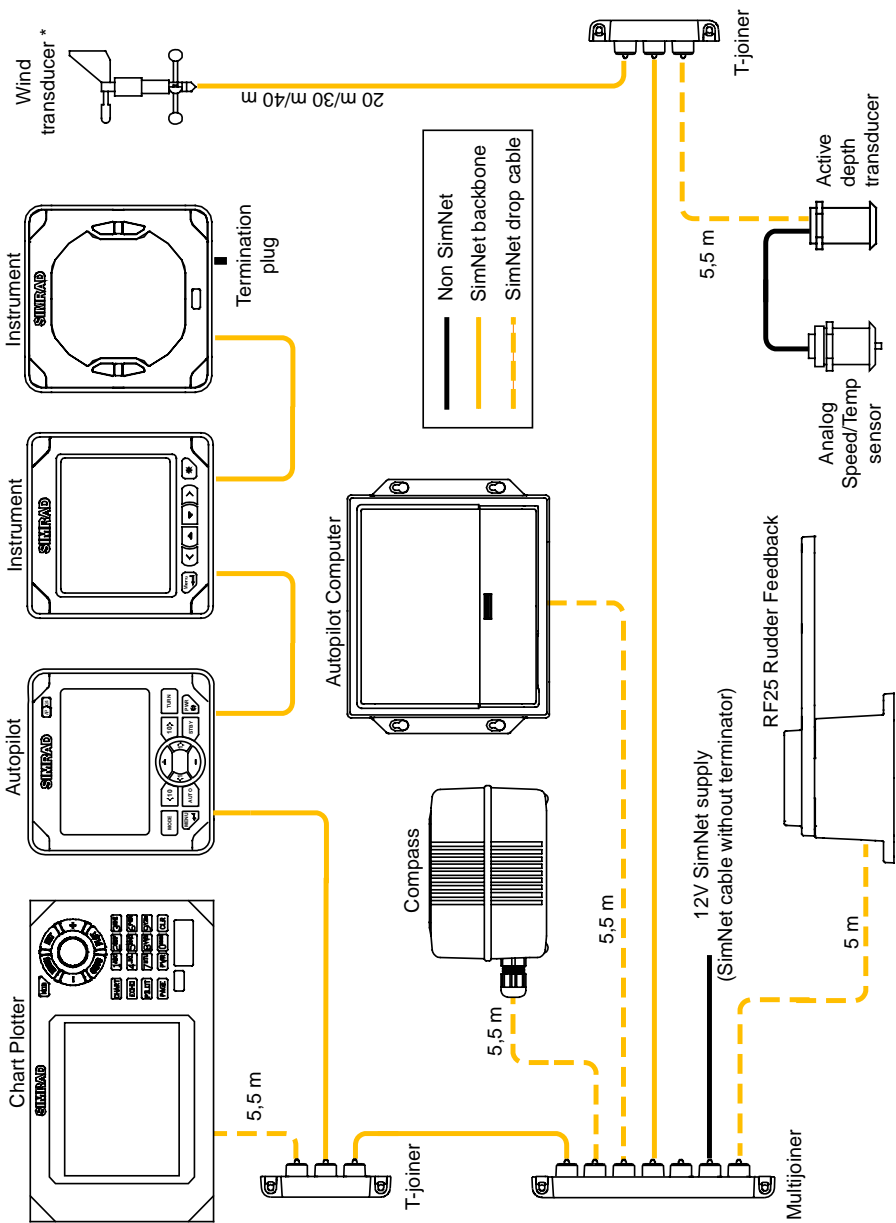

SimNet network, medium system

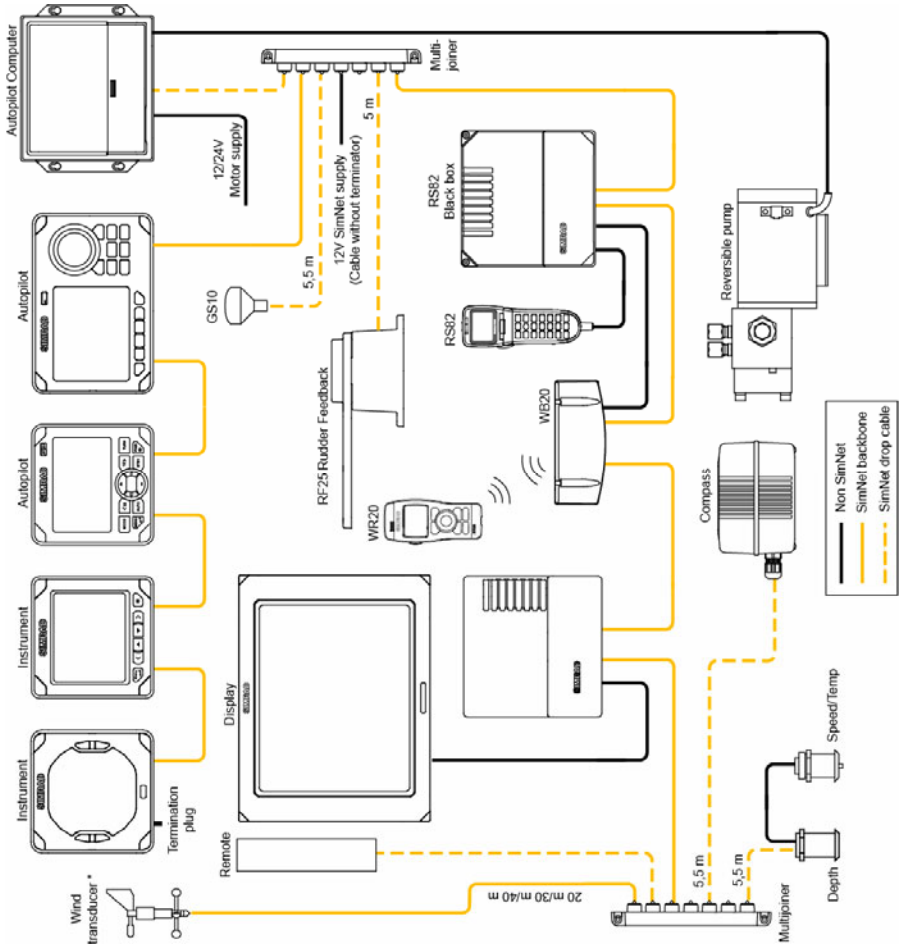

*SimNet network, expanded system*





1. Maximum total length of SimNet cables is 150 m (500 ft.)
2. Drop cables must not exceed 6 m (19 ft) of length and the total length of drop cables must not exceed 60 m (200 ft).
3. Equipment should not be daisy-chained in a drop cable.
4. The wind transducer (\*) has a built in terminator.

### Connecting IS20 to an NMEA2000 network



No daisy-chain connection is permitted between SimNet units when connected to an NMEA2000 network!

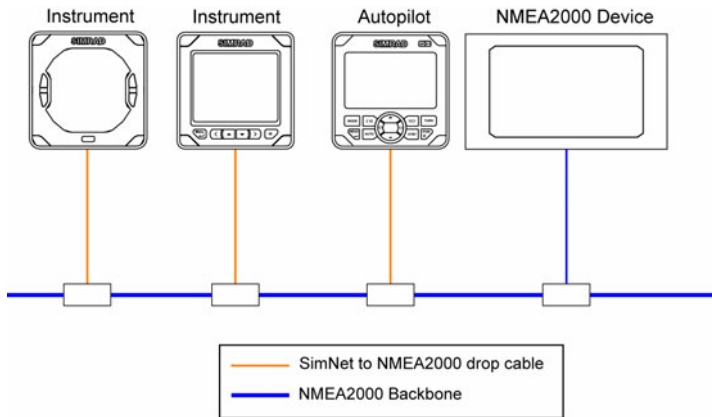

Use the SimNet cable (part no 24005729) to connect the IS20 to an MNEA2000 network.

## Connecting IS20 to an NMEA0183 output unit

The IS20 instrument may be used as repeater for data from a device with an NMEA0183 output port (NMEA "talker").

Use a repeater that is suitable for the type of data you want to present and the way you want it presented, i.e. digital or analog, multiple data from a GPS/Chart plotter or heading from a compass.

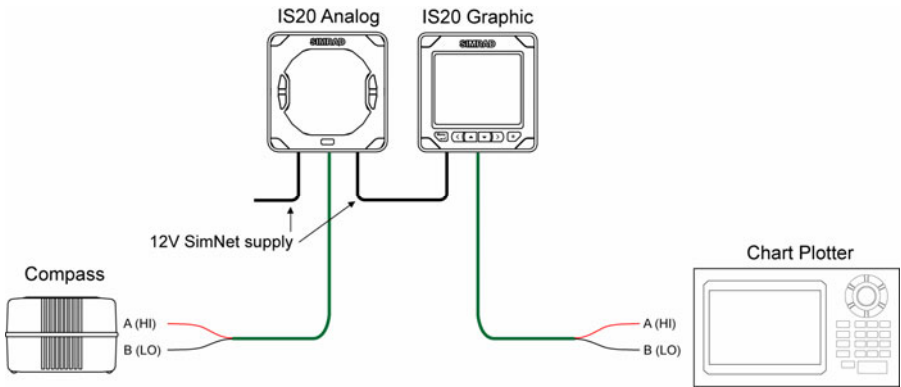

Use the NMEA0183 Interface cable (part no 22098495) to connect an NMEA0183 output device to IS20.

*Blank page*

# 5 Configuration

## 5.1 General

In this section the configuration procedure is described completely for each instrument type.

IS20 Rudder: page 36 - 39

IS20 Compass: page 40 - 44

IS20 Wind/Tack: page 45 - 48

## 5.2 No calibration function available

Some sensors that supply data on SimNet may not have or offer access to a calibration function.



Missing calibration function is indicated as shown in the illustration.

## 5.3 IS20 Rudder

### Setting the heading reference

The IS20 Analog instruments may be set to reference either Magnetic or True heading.

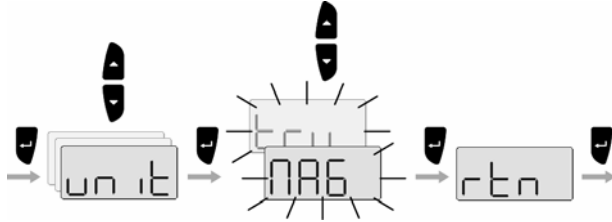

*If True heading is selected, the magnetic variation must be available from a GPS receiver!*

LCD	Parameter value	Default
MAG	Magnetic	Magnetic
tru	True	

## Heading offset

The compass heading should be checked against a known reference, a compensated compass or a bearing. If any permanent heading offset is present, use the heading offset parameter to compensate for the error.

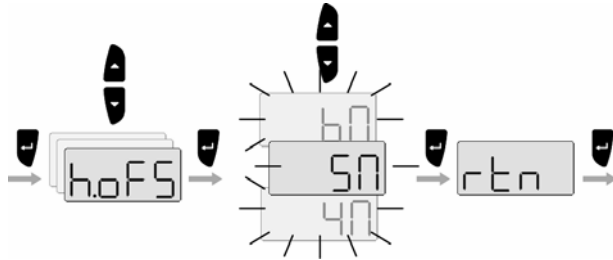

Range	Change per step	Default value	Units
-180 - +180	1	0	°

## Rudder feedback calibration

The rudder calibration is used to compensate for any non-linearity in the transmission between the rudder and the rudder feedback unit.

### *Adjusting the maximum rudder angle*

1. Start the calibration as illustrated below
2. Eventually adjust the maximum starboard (**Stbd** / **S.xx**) and port (**Port** / **P.xx**) rudder angle
3. Press the **Enter** key to confirm the adjustments and to finish the calibration as shown

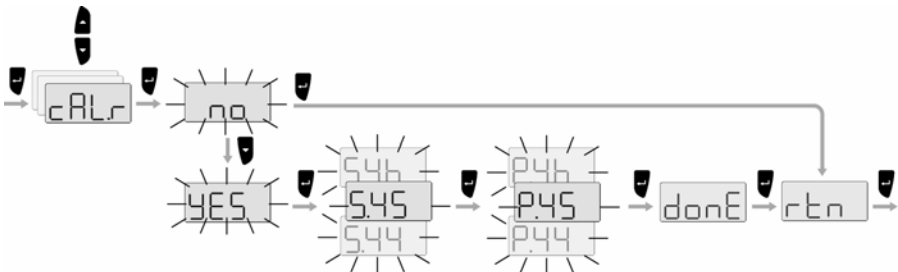

### ***Setting the rudder zero position***

This adjustment should be made in calm sea. Side forces from wind or current should be avoided.

1. Bring the boat up to cruising speed, and head directly into the wind
2. If the boat has twin engines, synchronize the engine RPM's
3. Set the trim tabs and stabilizers to have no effect on the boats heading
4. Steer the boat manually on a steady course
5. Refer to the illustration below for setting the current rudder position to zero

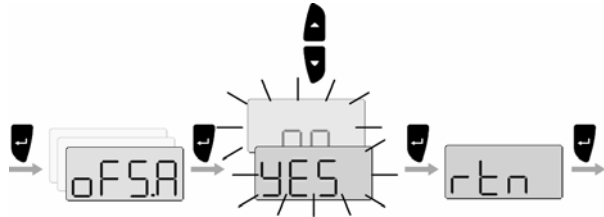

### **Displaying actual rudder angle**



This menu item is used to display actual rudder angle.

## Setting the unit's instance number

The instance number is used to identify multiple units of the same model when connected to a SimNet or NMEA2000 network. The instance number is added to the product name e.g. IS20-3 for easy identification of the unit.

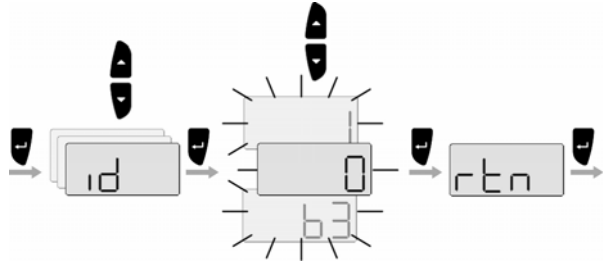

Range	Change per step	Default value
0 – 63	1	0



## 5.4 IS20 Compass

### Setting the heading reference

The IS20 Analog instruments may be set to reference either Magnetic or True heading.

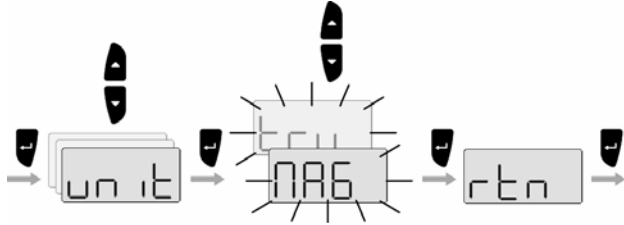

*If True heading is selected, the magnetic variation must be available from a GPS receiver!*

LCD	Parameter value	Default
MAG	Magnetic	Magnetic
true	True	

## Setting the magnetic variation

If the instrument is connected to a GPS the magnetic variation compensation will be read from the GPS, and it will not be possible to adjust the magnetic variation.

If a GPS is not connected the magnetic variation may be entered manually.

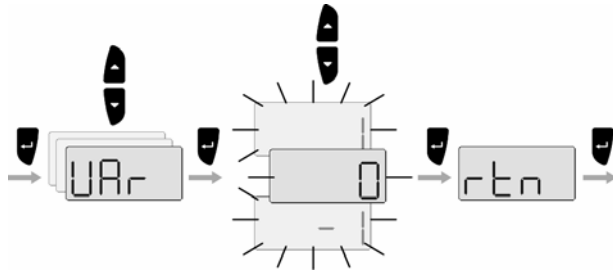

Range	Change per step	Default value
-180 – 180	1	0

## Compass calibration



***Do not attempt to start calibration when the IS20 and an autopilot are part of the same system unless the autopilot is in STBY mode!***

Before the compass calibration is started, make sure that there is enough open water around the vessel to make a full turn.

The calibration should be done in calm sea conditions and with minimal wind to obtain good results. Use about 60-90 seconds to make a full circle.

1. Begin turning the boat to port or starboard
2. Refer to the illustration below to start the automatic compass calibration

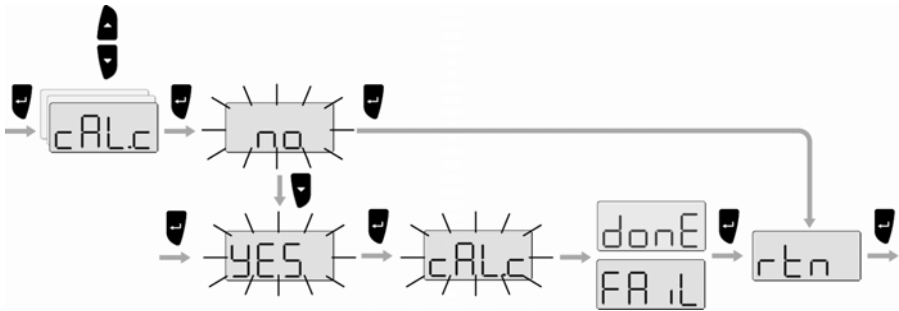

FAIL

A failing calibration could occur if:

- The compass is located too close to a local magnetic object
- The autopilot is not set to STBY mode



***If an autopilot is part of the same SimNet system, the autopilot should be used to calibrate the compass!***

## Heading offset

The compass heading should be checked against a known reference, a compensated compass or a bearing. If any permanent heading offset is present, the heading offset parameter should be used to correct for the error.

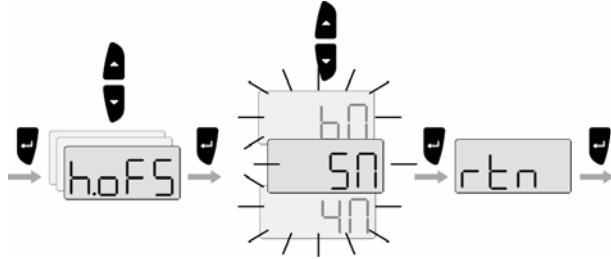

Range	Change per step	Default value	Units
-180 - +180	1	0	°

## Setting the unit's instance number

The instance number is used to identify multiple units of the same model when connected to a SimNet or NMEA2000 network. The instance number is added to the product name e.g. IS20-3 for easy identification of the unit.

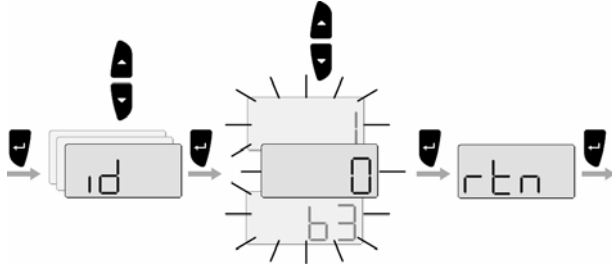

Range	Change per step	Default value
0 – 63	1	0

## 5.5 IS20 Wind and IS20 Tack

### Alarm setup

The IS20 may be set up to sound an alarm if w parameters exceeds preferred values.

The alarm monitoring is disabled by setting the value to **Off**.

#### *Wind shift alarm*

The wind shift alarm will monitor the wind angle. The reference angle is set when the alarm is turned on, and reset to present wind angle when an alarm is acknowledged.

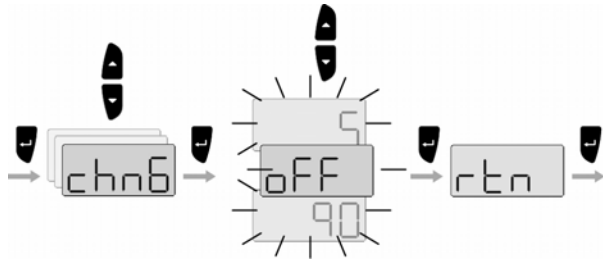

Range	Change per step	Default value
90° – Off	1°	Off

### Wind speed alarms

The true wind alarms may be set for high and low wind measurements:

ALh 1

- True wind speed too high

ALLo

- True wind speed too low

The illustration example shows how to set the True wind alarm limit.

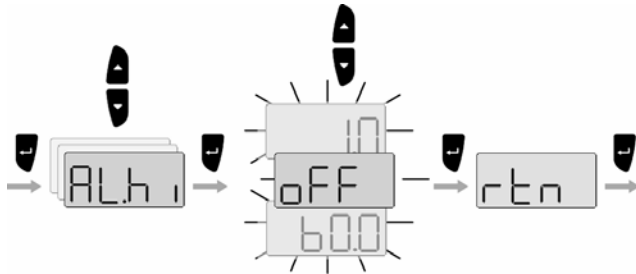

Range	Change per step	Default value
60 kt - Off	1 kt	Off

## Setting the units of measure

The displayed units for wind and boat speed may be set according to the table below.

Parameter	Options	Default
Wind speed unit unit	- kn    kn	kn
	- mph    mph	
	- m/s    m/s	
Boat speed unit bS.un	- kn    kn	kn
	- mph    mph	
	- km/h    km/h	

The illustration example shows how to set the Wind speed unit.

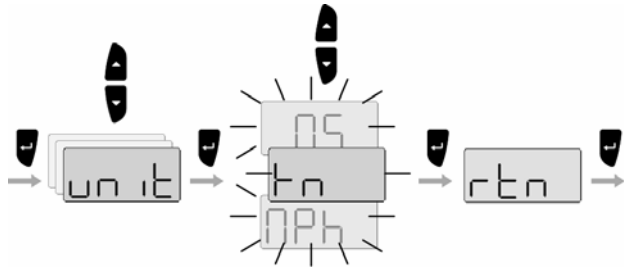



## Calibrating the wind sensor

The IS20 instruments can be automatically corrected for any error in the wind sensor mounting.

- 1 Bring the boat up to cruising speed, and head directly into the wind
- 2 Press the keys as illustrated below to perform the automatic calibration

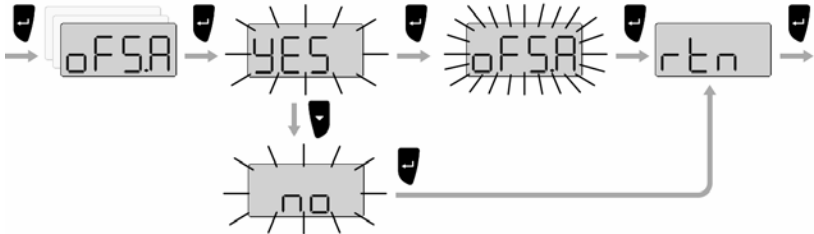

## Setting the unit's instance number

The instance number is used to identify multiple units of the same model when connected to a SimNet or NMEA2000 network. The instance number is added to the product name e.g. IS20-3 for easy identification of the unit.

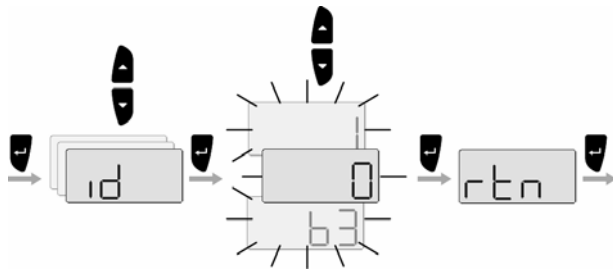

Range	Change per step	Default value
0 – 63	1	0

## 6 Maintenance

### 6.1 General maintenance

The IS20 instruments are “repair by replacement” units, and the operator is therefore required to perform only a very limited amount of preventive maintenance.

If the unit requires any form of cleaning, use fresh water and a mild soap solution (not a detergent). It is important to avoid using chemical cleaners and hydrocarbons such as diesel, petrol etc.



Make sure that all open SimNet connectors are fitted with a protection cap (part no 24006355).

Always put on the weather cover when the unit is not in use.

### 6.2 Resetting the instrument system

The reset option will reset the instrument to default settings.

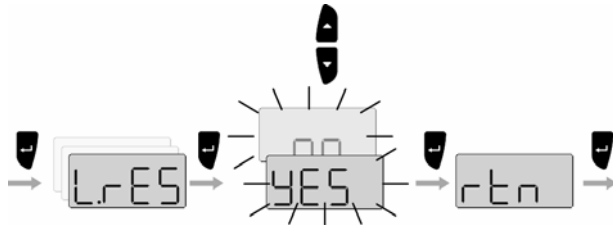











***The Installation and Setup procedures must be repeated after a reset has been performed!***

*Blank page*

## 7 Spare parts

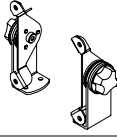
### 7.1 Spares and auxiliaries

Part no.		Description
22096028		IS20 Rudder instrument head
22096655		IS20 Compass instrument head
22096002		IS20 Wind instrument head
22096671		IS20 Tack instrument head
22096630		Mounting kit including:
		- 4 screws
		- 6 corners
		- 1 SimNet blocking plug
22096515		Weather cover
22096820		Bracket kit 1
24006355		SimNet blocking plug
22098495		NMEA0183 Interface cable 2.5 m (8')

## 7.2 SimNet cables and accessories

Art. no.	Description
24005829	0.3 m (1') SimNet cable (SDC:0.3M)
24005837	2 m (6.6') SimNet cable (SDC:02M)
24005845	5 m (16.6') SimNet cable (SDC:05M)
24005852	10 m (33') SimNet cable (SDC:10M)
24005860	SimNet T-joiner (SDJ) (3p)
24006298	SimNet Multijoiner (7p)
24006306	SimNet Bulkhead T-connector
24005878	SimNet cable gland
24005886	SimNet protection plug
24005894	SimNet termination plug
24005902	2 m (6.6') SimNet power w/termination
24005910	2 m (6.6') SimNet power w/o termination
24005936	AT10 Universal NMEA0183 converter
24005944	AT15 Active T-connector, IS15
24005928	SimNet cable protection cap
24005729	SimNet cable to Micro-C male Cable that connects a SimNet product to a NMEA2000 network.
24006199	SimNet cable to Micro-C female cable that connects a NMEA2000 product to SimNet

## 8 Specifications

### 8.1 Technical specifications

Weight: ..... 0,3 kg (1.1 lbs)

Power consumption ..... 1,5 W

SimNet Network Load (NL): ..... 3 NL

Color: ..... Black

Display:

Type: .... Custom made 4 characters 7 segment LCD

Illumination (Red or white): . Adjustable in 10 steps

Environmental protection:

Front ..... IP56

Back: ..... IP43

Safe distance to compass: ..... 0.3 m (1.0 ft.)

Temperature:

Operating: ..... 0 to +55 °C (+32 to +130 °F)





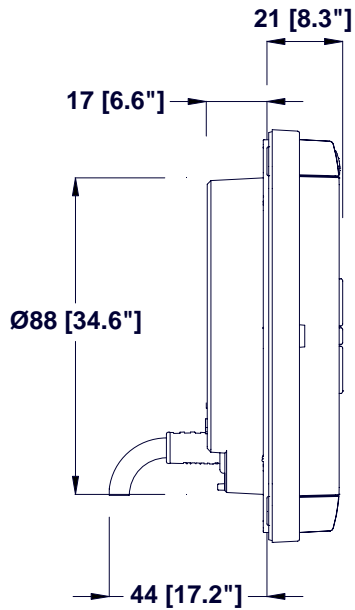
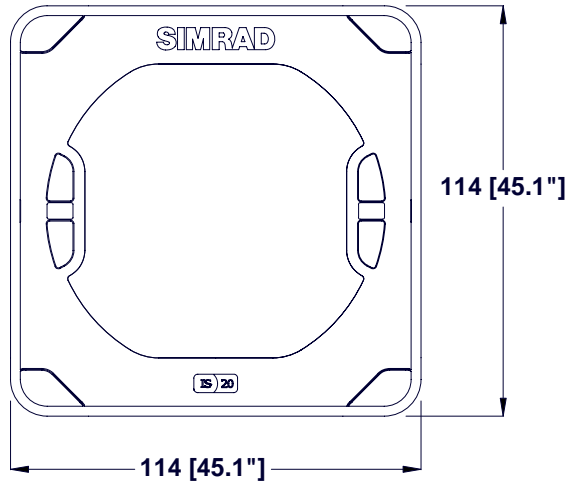





Storage: ..... -30 to +70 °C (-22 to +158 °F)

## 8.2 Dimensional drawing





## 8.3 Menu options

### IS20 Rudder

Display	Description	Range	Default
	Backlight day/ night	day/nitE	day
	Backlight Color white/red	White/red	White
	Backlight Group	0 – 6	
	Damping, Apparent Wind	0 – 9	1
	Heading unit		
	Compass offset adjust		
	Rudder feedback calibration		
	Automatic rudder offset		
	Actual rudder angle		
	Device Instance number	0 – 63	0
	Local reset	YES – no	YES



Display	Description	Range	Default
	Demo mode	On – off	off
	Save power		
	Exit menu (return to function display)		



## IS20 Compass

Display	Description	Range	Default
dAY	Backlight day/ night	day/nitE	day
colr	Backlight Color white/red	White/red	White
b.L.Gr	Backlight Group	0 – 6	
dAMP	Damping, Apparent Wind	0 – 9	1
un it	Heading unit		
VAR	Magnetic variation		
cALc	Compass calibration		
h.oFS	Compass offset adjust		
id	Device Instance number	0 – 63	0
L.rES	Local reset	YES – no	YES
dENo	Demo mode	On – off	off
S.PUr	Save power		

Display	Description	Range	Default
	Exit menu (return to function display)		

## IS20 Wind and IS20 Tack

Display	Description	Range	Default
dAY	Backlight day/ night	day/nitE	day
colr	Backlight Color white/red	White/red	White
b.L.Gr	Backlight Group	0 – 6	
dANP	Damping, Apparent Wind	0 – 9	1
chn6	Alarm, Wind shift	Off, 5-90	
AL.h i	Alarm, True wind speed too high	Off, 1 – 60	Off
AL.Lo	Alarm, True wind speed too low	Off, 1 – 60	Off
un it	Wind Speed units	knot, MS, Mph	knot
bS.un	Boat Speed units	knots, Mph, KMh	knots
oFSA	Wind offset, auto adjustment	YES – no	YES
id	Device Instance number	0 – 63	0
L.rES	Local reset	YES – no	YES
dENo	Demo mode	On – oFF	oFF

Display	Description	Range	Default
	Save power		
	Exit menu (return to function display)		

Doc.no. 20222584, Rev.B



Master the Elements